



The Intelligent Surveillance Solution

Hardware & Software Installation user's manual

Ver. 99.333.A520.001

TABLE OF CONTENTS

TABLE OF CONTENTS 1

1000 SERIES; 2000 SERIES; 3000 SERIES 2

 Product Specification 2

 System Requirement 2

 Hardware Installation 3

5000 SERIES 9

 Product Specification 9

 System Requirement 9

 Hardware Installation 10

6000 SERIES 12

 Product Specification 12

 System Requirement 12

 Hardware Installation 13

7000 SERIES 15

 Product Specification 15

 System Requirement 15

 Hardware Installation 16

DRIVER INSTALLATION 18

SOFTWARE INSTALLATION 20

APPENDIX - MINIMUM HARDWARE REQUIREMENT 25

System Requirement

1000 SERIES; 2000 SERIES; 3000 SERIES

Product Specification

G3 Card

	3000 Series	2000 Series	1000 Series
Display Rate	120fps(NTSC); 100fps (PAL)	60fps(NTSC); 50fps (PAL)	30fps(NTSC); 25fps (PAL)
Recording Rate	120fps(NTSC); 100fps (PAL)	60fps(NTSC); 50fps (PAL)	30fps(NTSC); 25fps (PAL)
Maximum Card	2	4	4
Video Input	4; 8; 12; 16	4; 8	4; 8
Audio Input	4	2	1
Video Resolution	NTSC: 704x480 ; 640 x 480 ; 352x240 PAL: 704x576 ; 640 x 576 ;352x288		
Compression Format	Software Compression MPEG 4		

System Requirement

The system requirement is depend on the number of camera connections and the total bit rate of the IP cameras. Please refer [Appendix - Minimum Hardware Requirement](#) or check NUUO Calculator on <http://support.nuuo.com/calculator/>

Hardware Installation

Hardware Installation

For G3-card and R-card, the hardware installation steps are all the same except the connection of Audio/Video Cable. The following figure shows the detail.

Step 1: Insert the card onto an empty PCI slot. Connect the **Audio/Video Cable** to the connector in the same color.

Step 2: Turn on your PC and start Windows.

Step 3: Insert the included Software CD into CD-ROM.

Step 4: Refer the section Driver Installation on page 18 to install driver.

Step 5: After driver being installed, restart your PC.

Connect the Audio/Video Cable

1. G3-card

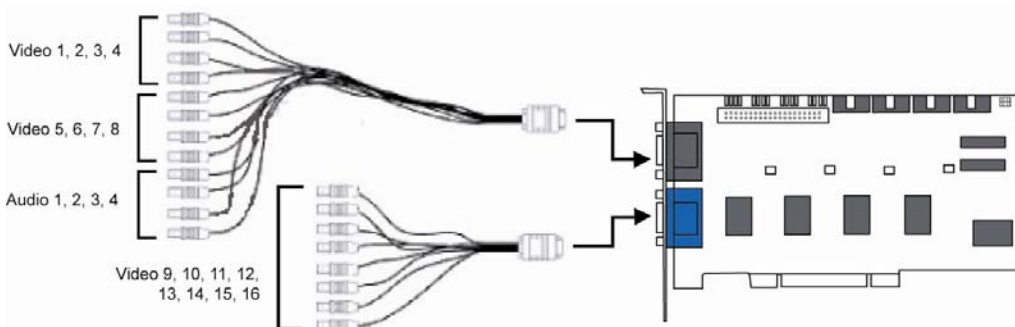

Note: for G3-3000 series, audio channels are located at 1, 2, 3, 4.

2. R-card

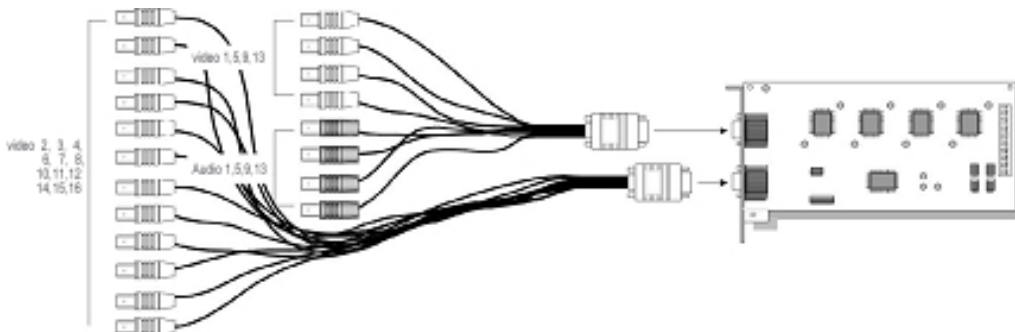

Note: for R- 3000 series, audio channels are located at 1,5,9,13.

Optional I/O Card referring to the figures on the following pages.

Insert the card onto your PC.

Connect the Capture Card and the I/O Card with an included ribbon cable. You may connect the ribbon cable to one of the I/O ports on the Capture Card.

G3-3000 Series Capture Card

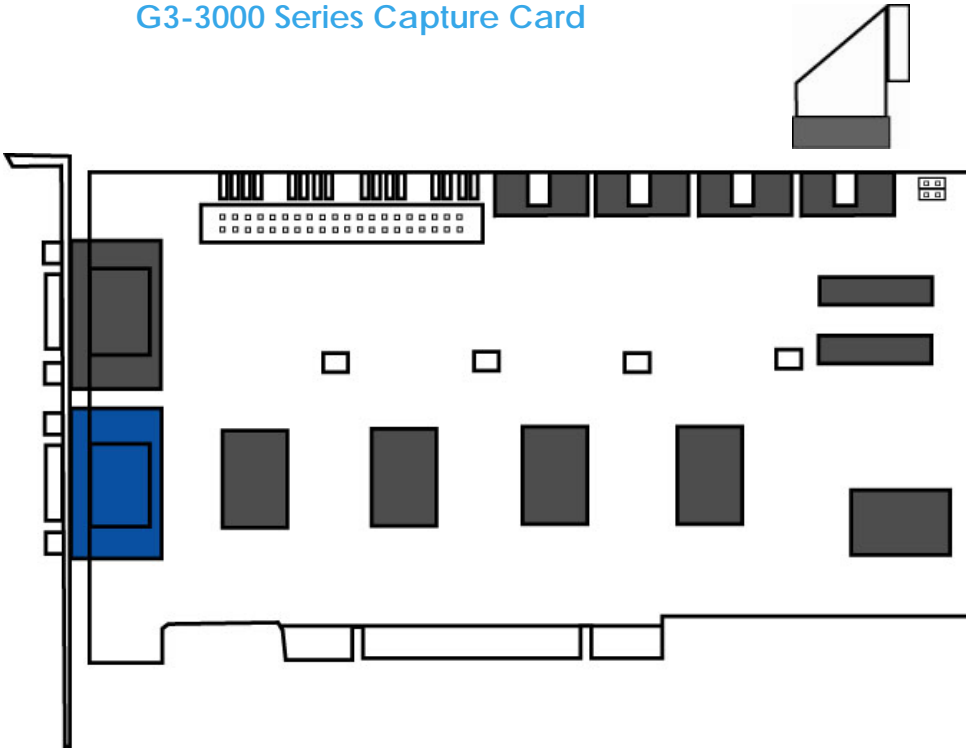

I/O Card

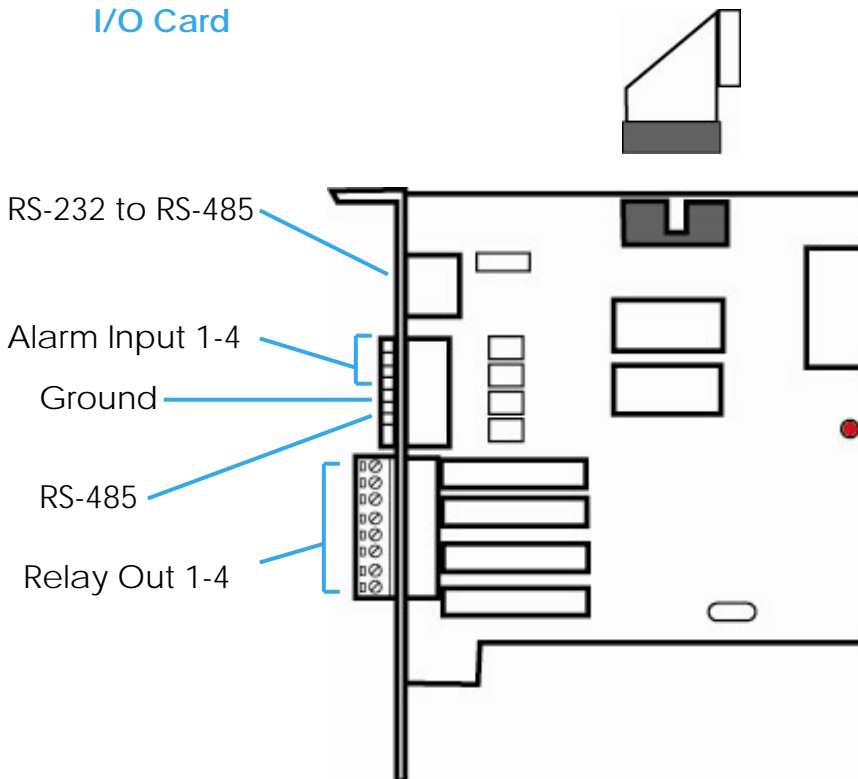

G3-2000 Series Capture Card

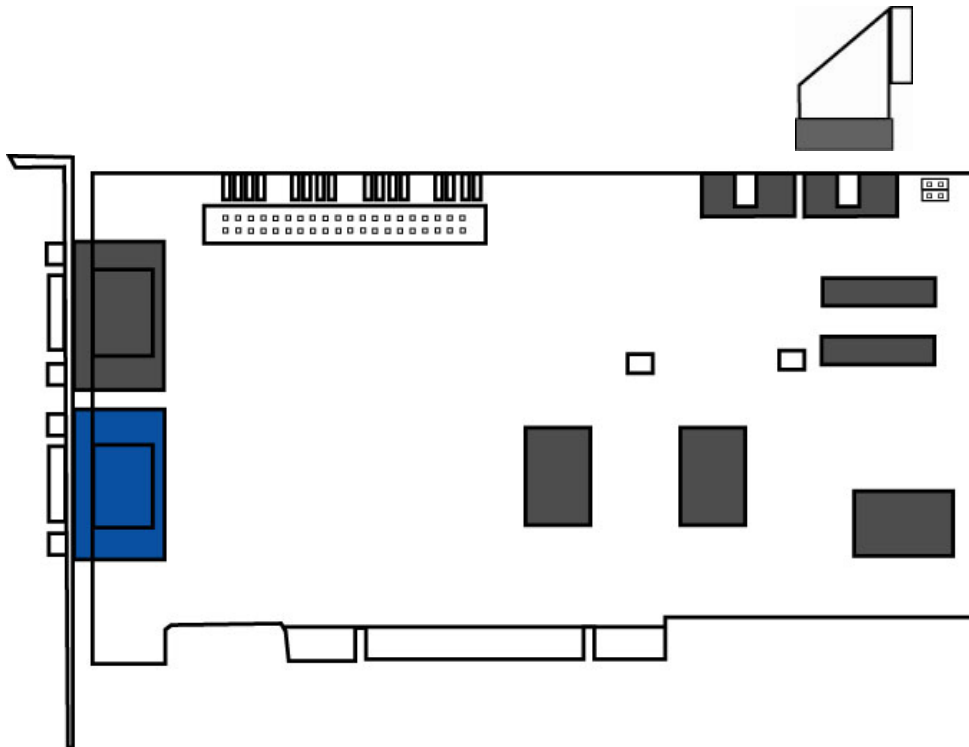

I/O Card

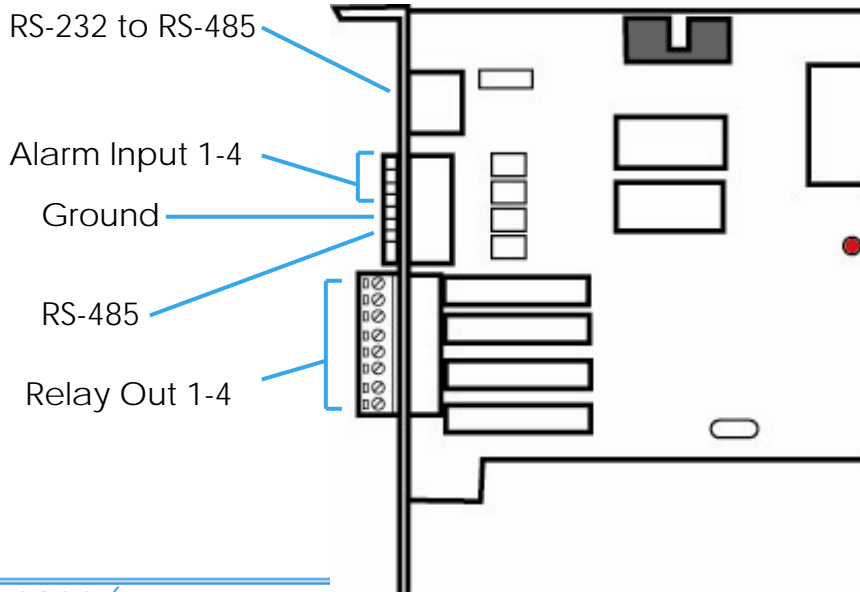

G3-1000 Series Capture Card

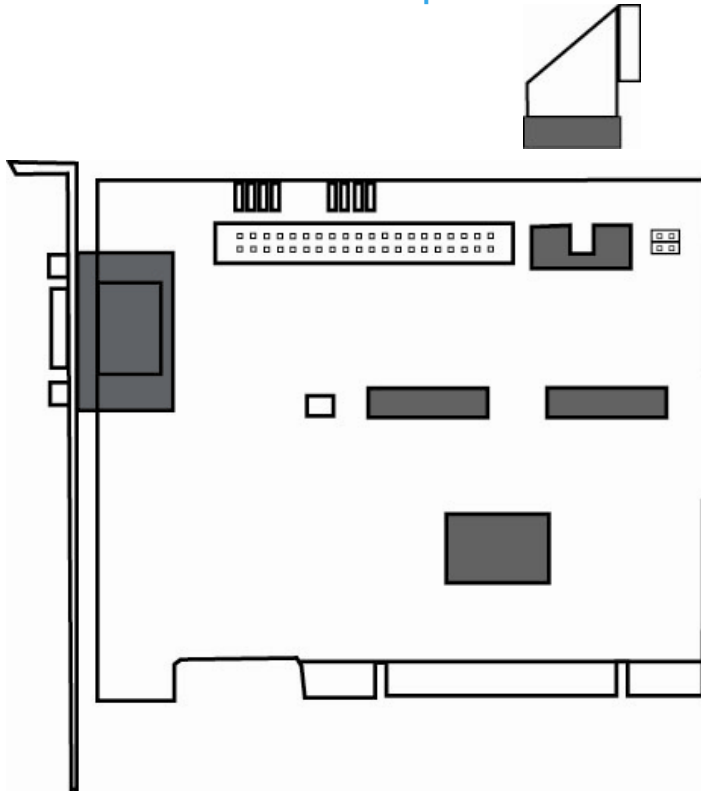

I/O Card

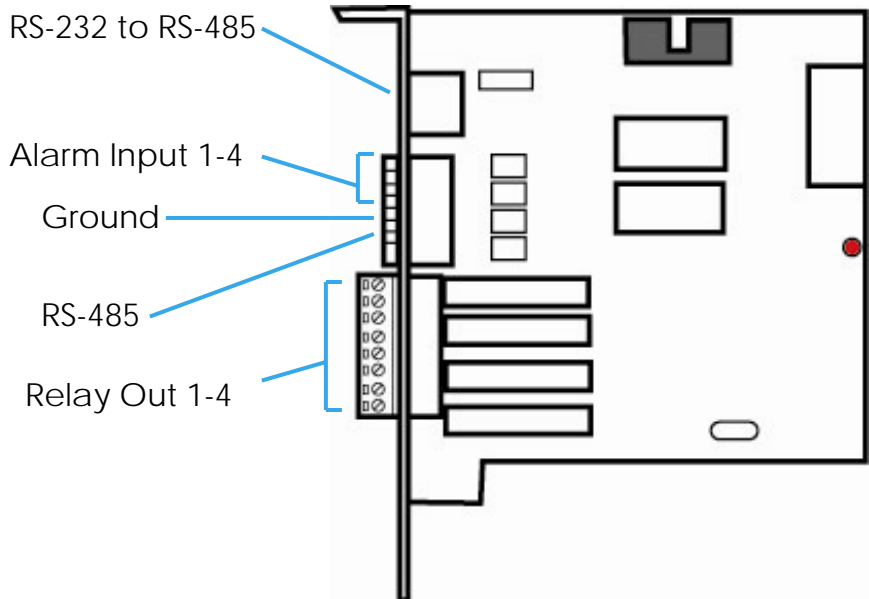

G3-card Watchdog Installation

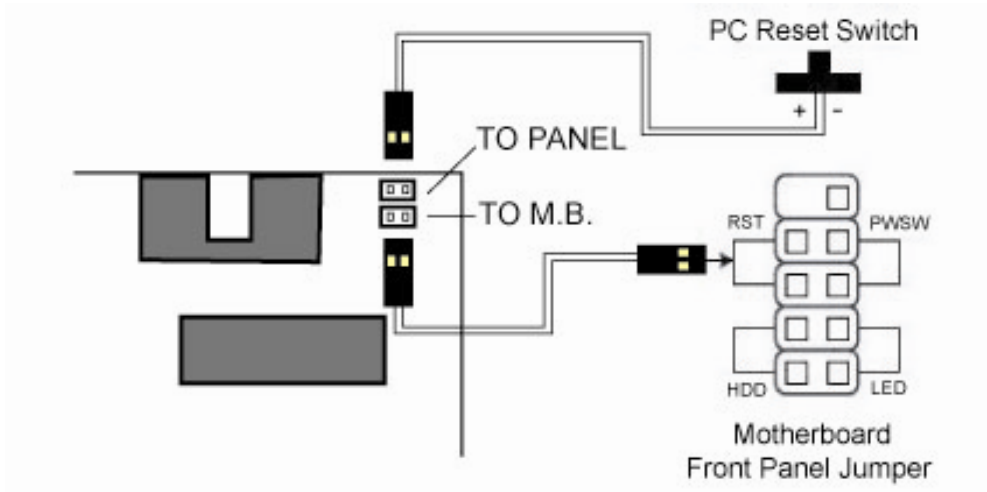

Product Specification

5000 SERIES

Product Specification

	5016	5008	5004
Display Rate	480fps(NTSC); 400fps (PAL)	240fps(NTSC); 200fps (PAL)	120fps(NTSC); 100fps (PAL)
Recording Rate	480fps(NTSC); 400fps (PAL)	240fps(NTSC); 200fps (PAL)	120fps(NTSC); 100fps (PAL)
Maximum Card	4	4	4
Video Input	16	8	4
Audio Input	16	8	4
Video Resolution	NTSC: 176x120; 352x240; 528x320; 704x480 PAL: 176x144; 352x240; 528x320; 704x480		
Compression Format	Hardware Compression H.264		

System Requirement

The system requirement is depend on the number of camera connections and the total bit rate of the IP cameras. Please refer [Appendix - Minimum Hardware Requirement](#) or check NUUO Calculator on <http://support.nuuo.com/calculator/>

Hardware Installation

Hardware Installation

Connecting the Audio/Video Cable - referring to the figure on next page.

The audio input connectors are with white wires and marks of "AID" on them; the video input connectors are with red wires and the marks of "VID".

Note: It is known that NUUO **5004 card** has compatibility problem with PPCI slot. NUUO 5004 cards can only be installed in **SPCI slots**. Normally, those 3 PCI slots nearest to CPU are PPCI slots. Avoid install 5004 card in these 3 slots. If driver was installed okay but one still encountered a problem shown below, try to install this 5004 card in another PCI slot.

5000 Series Capture Card

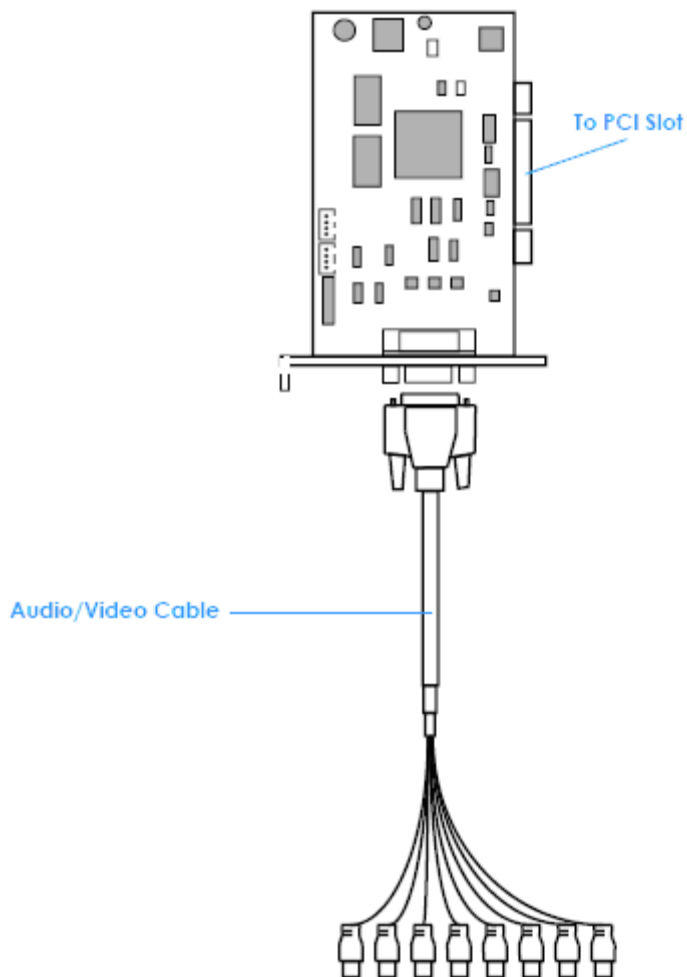

Product Specification

6000 SERIES

Product Specification

	6016	6008	6004
Display Rate	480fps(NTSC); 400fps (PAL)	240fps(NTSC); 200fps (PAL)	120fps(NTSC); 100fps (PAL)
Recording Rate (CIF)	480fps(NTSC); 400fps (PAL)	240fps(NTSC); 200fps (PAL)	120fps(NTSC); 100fps (PAL)
Maximum Card	2	4	4
Video Input	16	8	4
Audio Input	16	8	4
Video Resolution	NTSC: 176x120; 352x240; 704x480 PAL: 176x144; 352x288; 704x576		
Compression Format	Hardware Compression H.264		

System Requirement

The system requirement is depend on the number of camera connections and the total bit rate of the IP cameras. Please refer [Appendix - Minimum Hardware Requirement](#) or check NUUO Calculator on <http://support.nuuo.com/calculator/>

Hardware Installation

Connecting the Audio/Video Cable - referring to the figure on next page.

The audio input connectors are with yellow wires and marks of "A" on them (such as "A1/9"); the video input connectors are with black wires and the marks of "V" (such as "V8/16").

Connecting the Watchdog Wire - referring to the figure on next page.

Plug the **Watchdog Wire** to the **Reset** connector of the Hardware Compression Card and then connect it to the **Reset** connector on the main board.

With the **Watchdog Wire** connected, the system will be restarted if any abnormal conditions.

6000 Series Capture Card

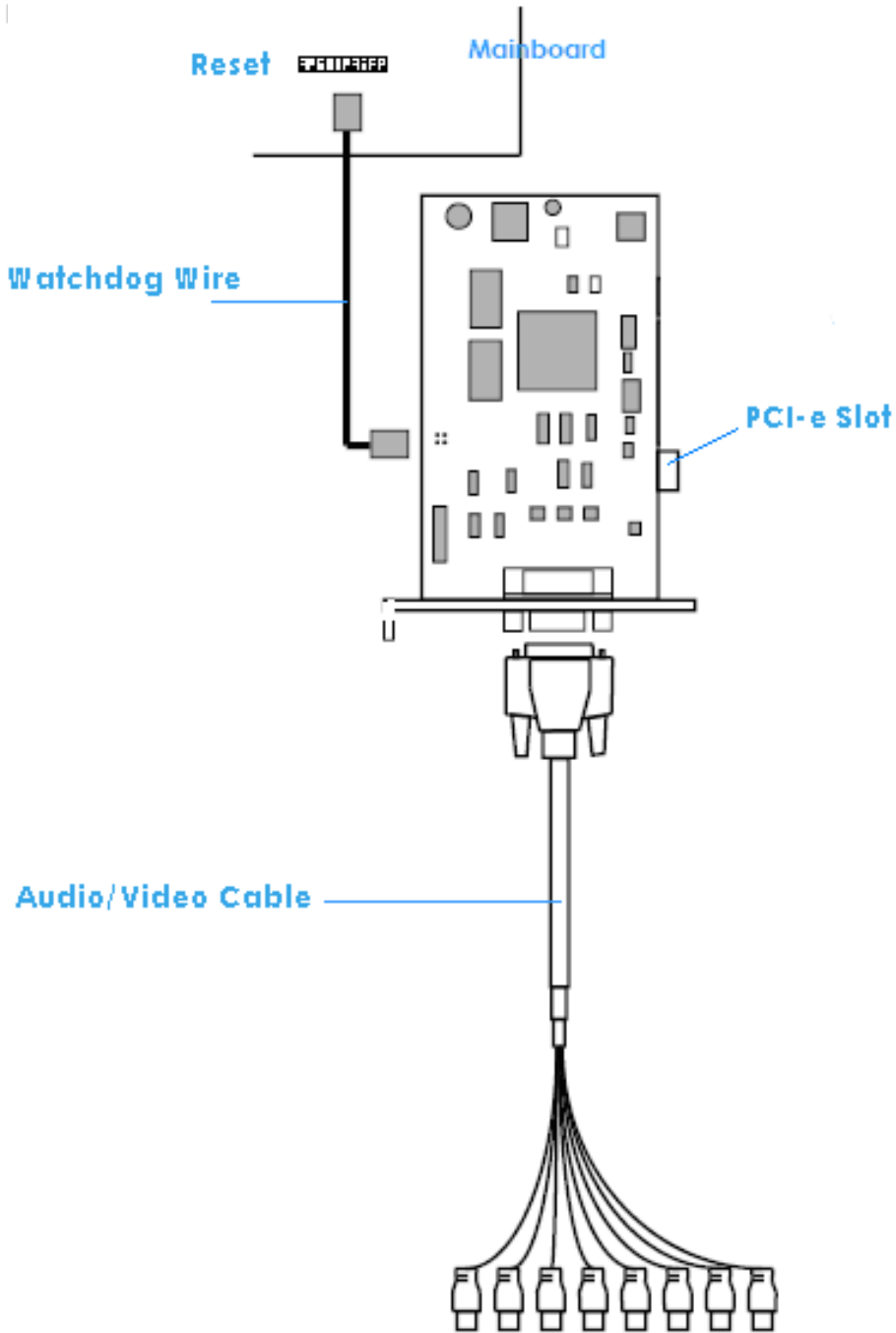

Product Specification

7000 SERIES

Product Specification

	7016	7008	7004
Display Rate	480fps(NTSC); 400fps (PAL)	240fps(NTSC); 200fps (PAL)	120fps(NTSC); 100fps (PAL)
Recording Rate (D1)	480fps(NTSC); 400fps (PAL)	240fps(NTSC); 200fps (PAL)	120fps(NTSC); 100fps (PAL)
Maximum Card	2	4	4
Video Input	16	8	4
Audio Input	16	8	4
Video Resolution	NTSC: 176x120; 352x240; 704x480 PAL: 176x144; 352x288; 704x576		
Compression Format	Hardware Compression H.264		

System Requirement

The system requirement is depend on the number of camera connections and the total bit rate of the IP cameras. Please refer [Appendix - Minimum Hardware Requirement](#) or check NUUO Calculator on <http://support.nuuo.com/calculator/>

Hardware Installation

Connecting the Audio/Video Cable - referring to the figure on next page.

The audio input connectors are with yellow wires and marks of "A" on them (such as "A1/9"); the video input connectors are with black wires and the marks of "V" (such as "V8/16").

Connecting the Watchdog Wire - referring to the figure on next page.

Plug the **Watchdog Wire** to the **Reset** connector of the Hardware Compression Card and then connect it to the **Reset** connector on the main board.

With the **Watchdog Wire** connected, the system will be restarted if any abnormal conditions.

Hardware Installation

7000 Series Capture Card

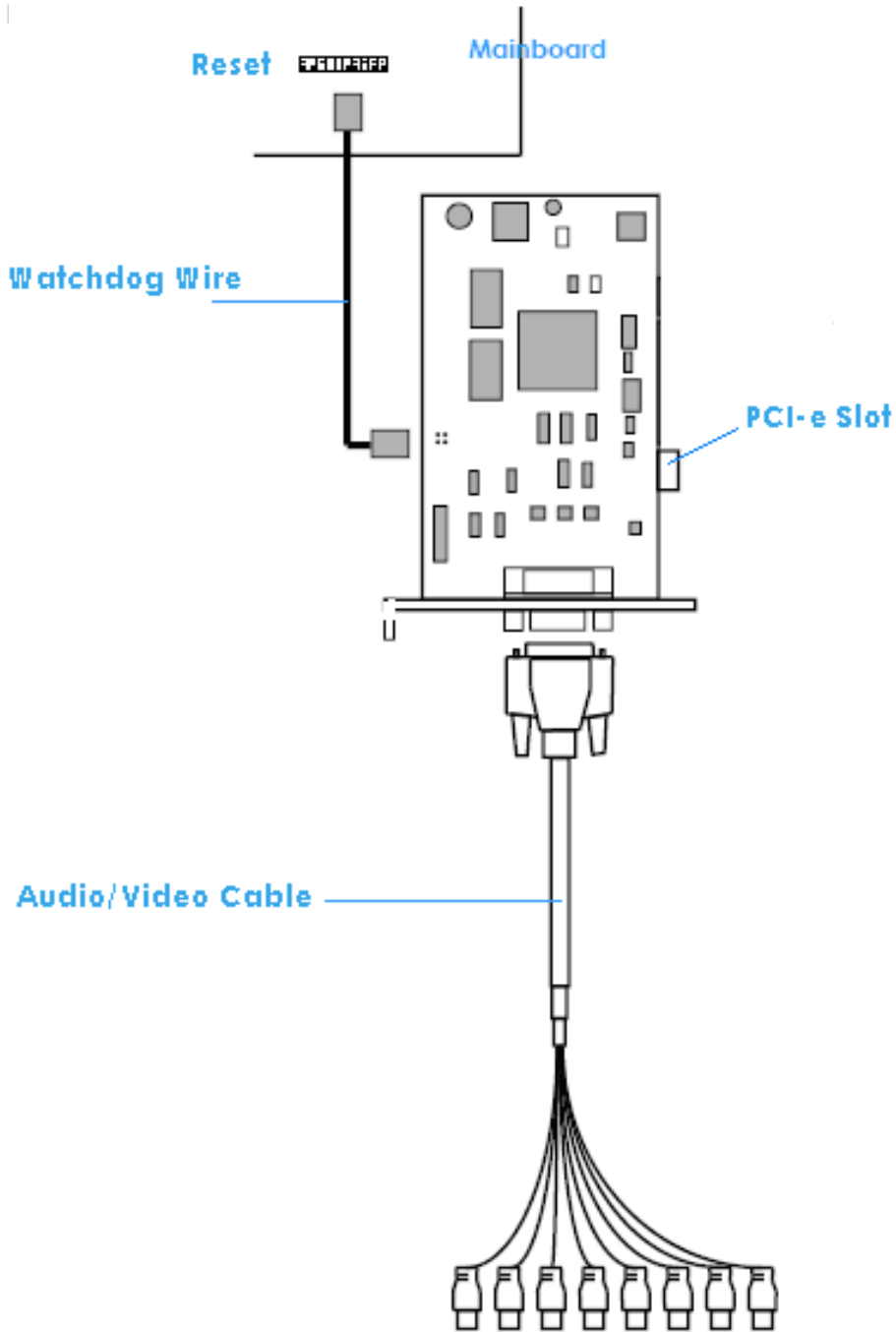

DRIVER INSTALLATION

Step 1: Insert the Installation CD. Run `autostartup.exe`  from the CD-ROM directly to start the installation.

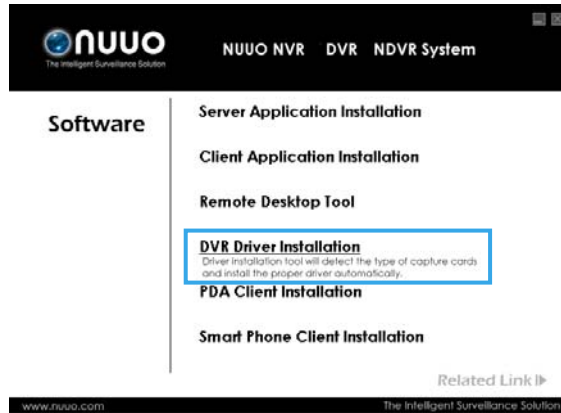

Step 2: Select "DVR Driver Installation" then click on it.

Step 3: In the NUUODriver Setup Wizard dialog box, click Next to continuous.



Step 4: Check the "License agreement". Click "I Agree" to continuous.

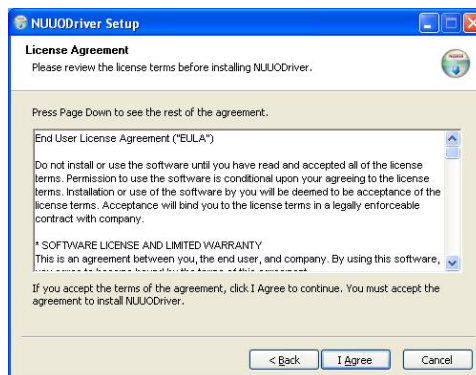

Driver Installation

Step 5: Installing NUUODriver.

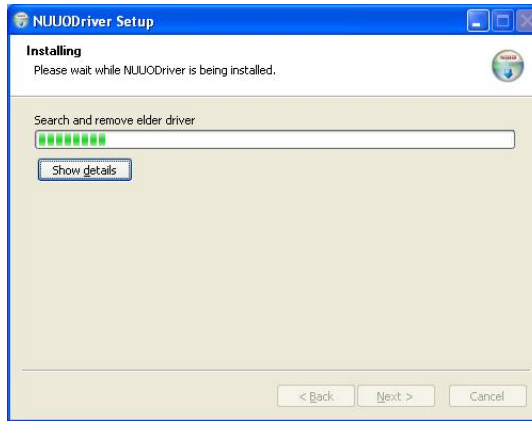

Step 6: Click "Finish" after installing the system completely, and then choose to reboot now or later.



SOFTWARE INSTALLATION

Step 1: Insert the Installation CD. Run Autorun Tool from the CD-ROM directly to start the installation.

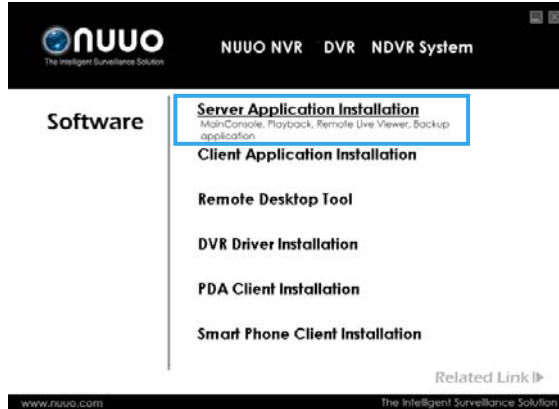

Step 2: Select "Server Application Installation" then click on it.

Step 3: There are 4 system types of options in "System Setup Tool" window, select one and click Next to start the installshield of Server package.

- NUUO IP Surveillance System/Trial System
- NUUO MPEG-4 Hybrid System
- NUUO H.264 Hybrid System
- NUUO Full D1H.264 Hybrid System

Note: The SetupTool will detect the type of capture cards installs on PC and enable the options of system types automatically.

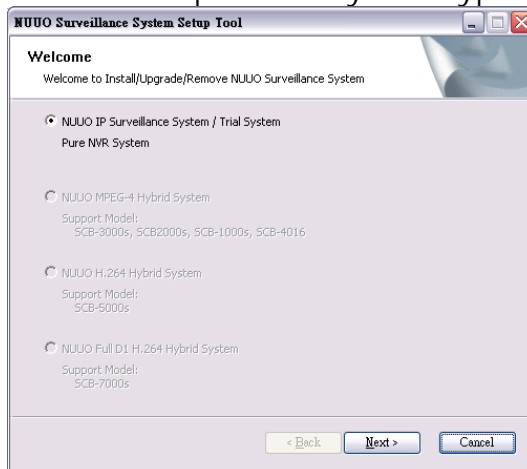

Software Installation

Step 4: In the InstallShield Wizard dialog box, click **Next** to continuous.

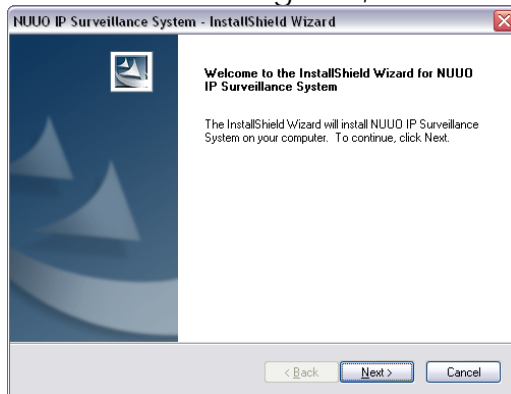

Step 5: Check the option "I accept the terms of the license agreement". Click **Next** to continuous.

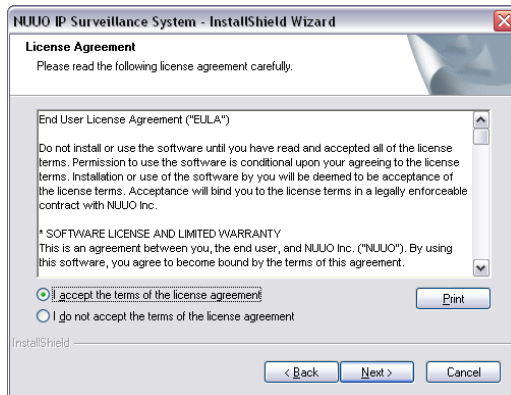

Step 6: Please enter your name and the company name for which you work. Click **Next** to continuous.

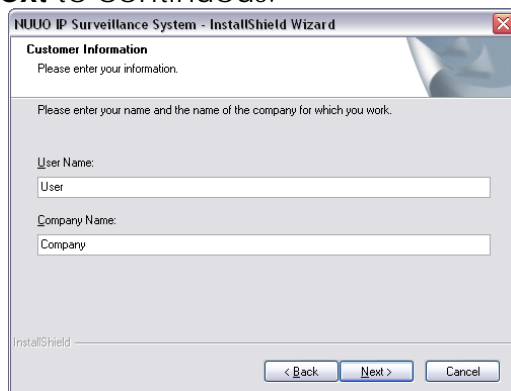

Step 7: Select "Complete Setup Type" or "Custom Setup Type" to install the System.

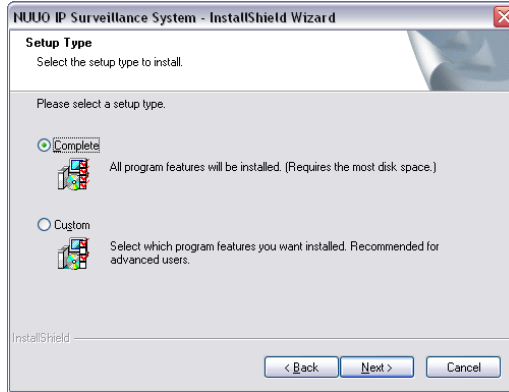

COMPLETE SETUP TYPE

Install all program features into the default directory.

- Check the option "**Complete**", and then click "**Next**". All program features will be installed. [Require the most disk space.]

CUSTOM SETUP TYPE

Install the system to a preferred directory. Or select whichever program feature(s) to install. This is recommended for advanced users.

- Check the option "**Custom**", and then click "**Next**".
- Select appointed folder where setup will install files to. Click "**Change**" to modify the installation directory.

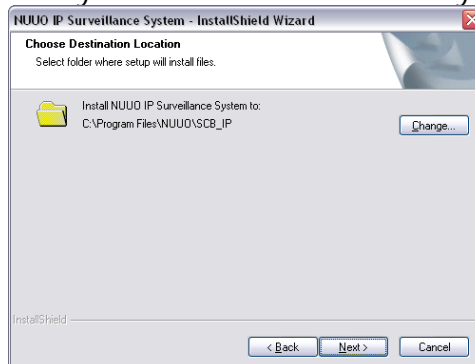

- Select the features setup will install. There are 4 features to choose in the server setup process: MainConsole, Playback, LiveView, Backup, and Verification tool. Click "**Next**" after confirmation.

Software Installation

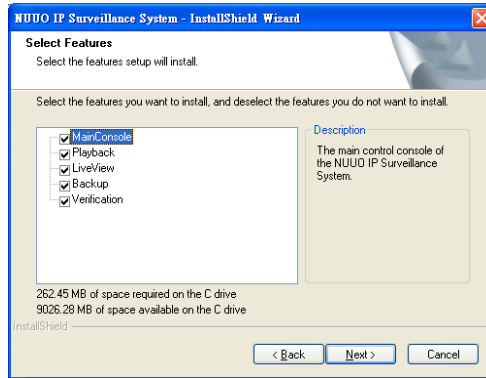

Step 8: Click install to start the installation.

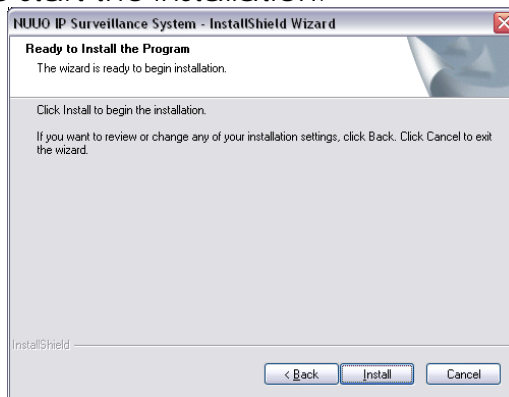

Step 9: Click Finish after installing the system completely.

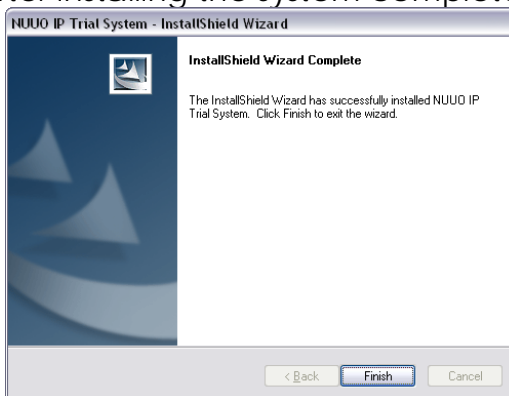

Software Installation

Execute the Main Console

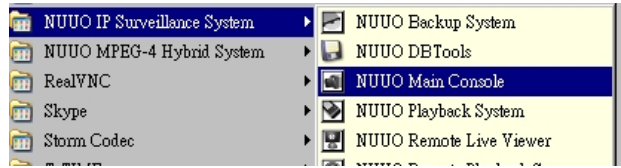

Enter the password you like into the edit box and enter again at the edit of Password Confirm. And then press "OK". Now enjoy our Intelligent Surveillance Solution.



APPENDIX - MINIMUM HARDWARE REQUIREMENT

This document is to illustrate the hardware requirement for NUUO DVR, NVR, and hybrid system. The requirement specified in this document is the minimum requirement indicated for the desire system.

Note:

1. Different chipset for motherboard and display card may have slightly different effect.
2. For detail **Hardware Compatibility List**, please refer http://support.nuuo.com/mediawiki/index.php/Hardware_compatibility_list

H.264 Hardware Compression Card (SCB-7000/6000 series)

	32 ch	16 ch	8 ch	4 ch
CPU	Intel Core 2 Quad Q9400*		Intel Core 2 Duo E5300	
RAM	2 GB			
Motherboard	Intel P45 or P43 chip or above, MB vendor Asus, Gigabyte or MSI with Intel Chipset recommended			
Display card	ATI Radeon 3850/4850 , nVIDIA GeForce GF-9600 or above (ATI Driver V9-2 recommended , ATI Driver V10 not support)			
Ethernet	100 baseT or above, gigabit LAN recommended			
Hard Disk	250 GB or above			
OS	MS Windows XP pro SP3 / 2003/ Vista SP1 / Win 7			

* Refer the document “System Requirements of NUUO SCB-7000 Series” for more details.

MPEG-4 Software Compression Card (SCB-1000/3000 series)

	SCB-3000s x 2	SCB-3000s	SCB-1000
CPU	Intel Core 2 DuoE5300		
RAM	2 GB		
Motherboard	Intel P45 or P43 chip or above, MB vendor Asus, Gigabyte or MSI with Intel Chipset recommended		
Display card	ATI Radeon 4650 , nVIDIA GeForce GF-9600 or above (ATI recommended)		
Ethernet	100 baseT or above, gigabit LAN recommended		
Hard Disk	250 GB or above		
OS	MS Windows XP pro SP3 / 2003 / Vista SP1/ Win 7		

Appendix – Minimum Hardware Requirement

Pure IP NVR

S of all cam.	D	C	B	A
	2200~1400	1400~1050	1050~550	550~
CPU	Intel Core I7	Intel Core I5	Intel Core 2 Quad Q9400	Intel Core 2 Duo E5300
RAM	2 GB	2 GB	2 GB	1 GB
Motherboard	Intel 55 or 57 chip or above, MB vendor Asus, Gigabyte or Intel with Intel Chipset recommended		Intel 35 or 33 chip or above, MB vendor Asus, Gigabyte or Intel with Intel Chipset recommended	
Display card	ATI Radeon 4650 , nVIDIA GeForce GF-9600 or above (ATI recommended)			
Ethernet	100 baseT or above, Gigabit LAN recommended			
Hard Disk	250 GB or above			
OS	MS Windows XP pro SP3 / 2003 / Vista SP1/ Win 7			

Parameter definitions:

S = M*N

M: parameter of resolution of IP camera

Resolution	5 M	3 M	2 M	1 M	VGA / D1	CIF
Value of M	37	27	22	14	3	1

N: FPS of Camera

For example: 8 channels system

- a) 1 camera at 1 Mega-pixel resolution with 10FPS
- b) 2 cameras at D1 resolution with 15FPS
- c) 5 cameras at CIF resolution with 30FPS

a) $M=14; N=10, S=14*10=140$

b) $M=3; N=15, S=3*15=45$

c) $M=1; N=30, S=1*30=30$

S of All Cam. = $1*140+2*45+5*30=380$

Therefore, the Minimum Hardware Requirement is **A level**.

**Appendix – Minimum Hardware Requirement
Hybrid System**

S of all cam.	D	C	B	A
	2200~1400	1400~1050	1050~550	550~
CPU	Intel Core I7	Intel Core I5	Intel Core 2 Quad Q9400	Intel Core 2 Duo E5300
RAM	2 GB	2 GB	2 GB	1 GB
Motherboard	Intel 55 or 57 chip or above, MB vendor Asus, Gigabyte or Intel with Intel Chipset recommended		Intel 35 or 33 chip or above, MB vendor Asus, Gigabyte or Intel with Intel Chipset recommended	
Display card	ATI Radeon 4650 , nVIDIA GeForce GF-9600 or above (ATI recommended)			
Ethernet	100 baseT or above, Gigabit LAN recommended			
Hard Disk	250 GB or above			
OS	MS Windows XP pro SP3 / 2003 / Vista SP1*/ Win 7*			

* 5000 series cannot be compatible with Vista and Win 7.

Parameter definitions:

S = M*N + P

M: parameter of resolution of IP camera

Resolution	5 M	3 M	2 M	1 M	VGA / D1	CIF
Value of M	37	27	22	14	3	1

N: FPS of Camera

P: parameter of NUUO compression card

Card	SCB-3000	SCB-1000
Value of P	120	30

Card	SCB-7016	SCB-7008	SCB-7004
Value of P	480	240	120

For example: 16 channels system

- a) 1 camera at 1 Mega-pixel resolution with 10FPS
- b) 2 cameras at D1 resolution with 15FPS
- c) 5 cameras at CIF resolution with 30FPS
- d) 8 cameras with 2pcs SCB-5004

a) M=14; N=10, **S** =14*10=140

b) M=3; N=15, **S** =3*15=45

c) M=1; N=30, **S** =1*30=30

d) P=60

S of All Cam. =1*140+2*45+5*30+2*60=500

Therefore, the Minimum Hardware Requirement is **A level**.