



The Intelligent Surveillance Solution

Hardware & Software NDVR Installation Guide

Ver. 3.5.10.110915.00

Table of Contents

TABLE OF CONTENTS

TABLE OF CONTENTS 1

1000 SERIES; 3000 SERIES 2

 Product Specification 2

 System Requirement 2

 Hardware Installation..... 3

 Maximum I/O Cards support for G3-3016 5

6000S/7000S SERIES 8

 Product Specification 8

 System Requirement 8

 Hardware Installation..... 9

 Maximum I/O Cards support for 6000S/7000S 11

7100 SERIES 12

 Product Specification 12

 System Requirement 12

 Hardware Installation..... 13

8000HD SERIES..... 15

 Product Specification 15

 System Requirement 15

 Hardware Installation..... 16

DRIVER INSTALLATION 18

SOFTWARE INSTALLATION 20

APPENDIX - MINIMUM HARDWARE REQUIREMENT 25

1000 SERIES; 3000 SERIES Product Specification

Model	3000 Series	1000 Series
Display Rate	120fps(NTSC); 100fps (PAL)	30fps(NTSC); 25fps (PAL)
Recording Rate	120fps(NTSC); 100fps (PAL)	30fps(NTSC); 25fps (PAL)
Maximum Card	2	4
Video Input	4, 8, 16	4, 8
Audio Input	4	1
Video Resolution	NTSC: 704x480 ; 640 x 480 ; 352x240 PAL: 704x576 ; 640 x 576 ;352x288	
Compression Format	Software Compression MPEG 4	

System Requirement

The system requirement depends on the number of camera connections and the total bit rate of the IP cameras. Please refer [Appendix - Minimum Hardware Requirement](#) or check NUUO Calculator on <http://support.nuuo.com/calculator/>

Caution



The electronic components within the unit are sensitive to damage from Electro-Static Discharge (ESD). Please take precautions at all times when handling the unit or its sub-assemblies.

Hardware Installation

Step 1: Insert the card onto an empty PCI slot. Connect the **Audio/Video Cable** to the connector in the same color.

Note: You need to power down the PC before you insert the card.

Step 2: Turn on your PC and start Windows.

Step 3: Insert the included Software CD into CD-ROM.

Step 4: Refer the section Driver Installation on page 18 to install driver.

Step 5: After driver is installed, restart your PC.

Connect the Audio/Video Cable

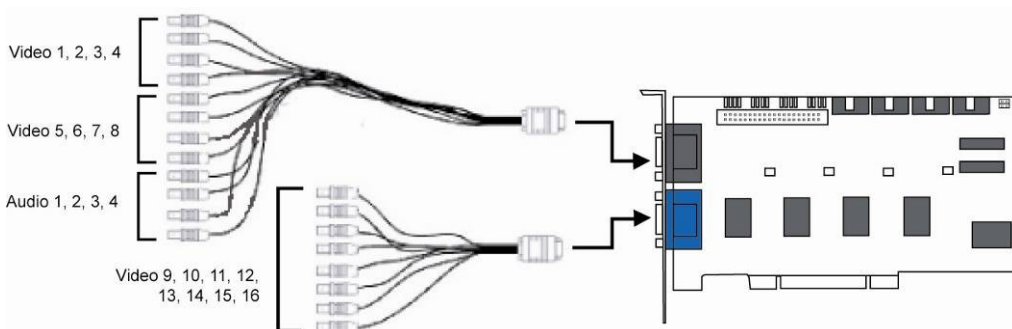

Note: for G3-3000 series, audio channels are located at 1, 2, 3, 4.

Optional I/O Card: refer to the figures on the following pages.

Step 1: Fix the IO card onto your PC.

Step 2: Connect the Capture Card and the I/O Card with an included ribbon cable (**2.54mm** IDC cable).

Note: The default configuration of blue slide switch on I/O Card as below.

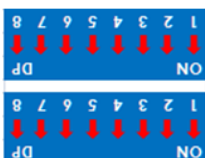

G3-3000 Series Capture Card

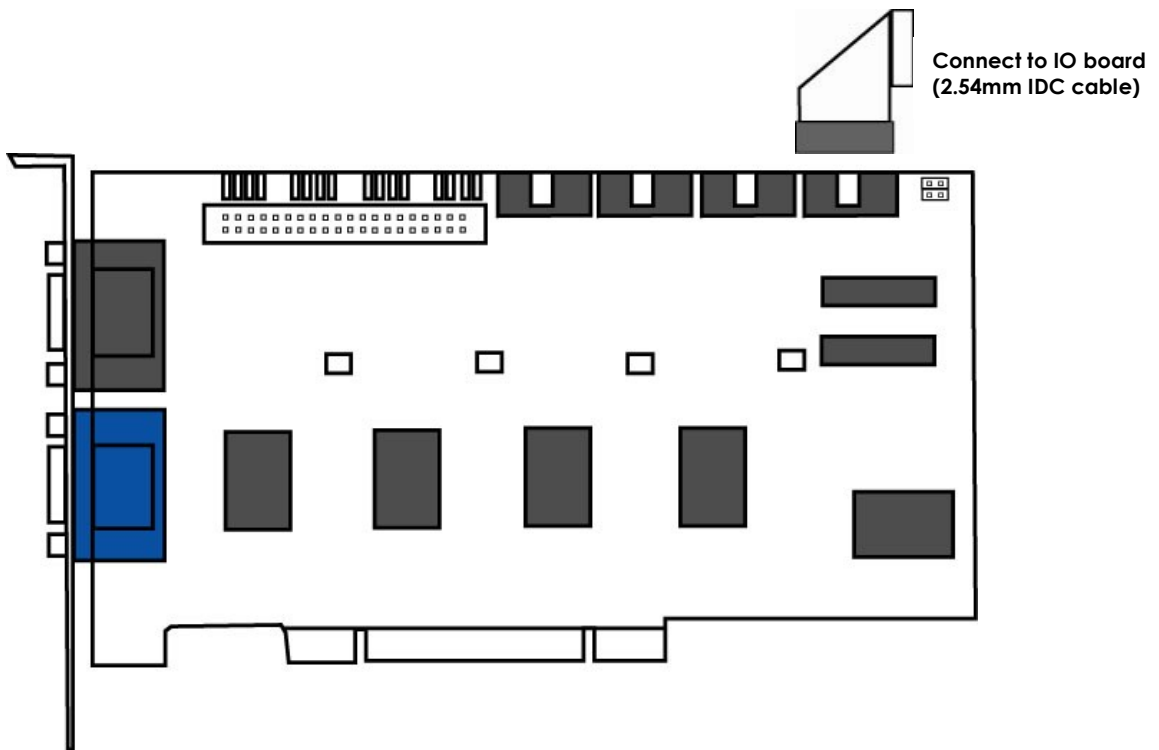

I/O Card

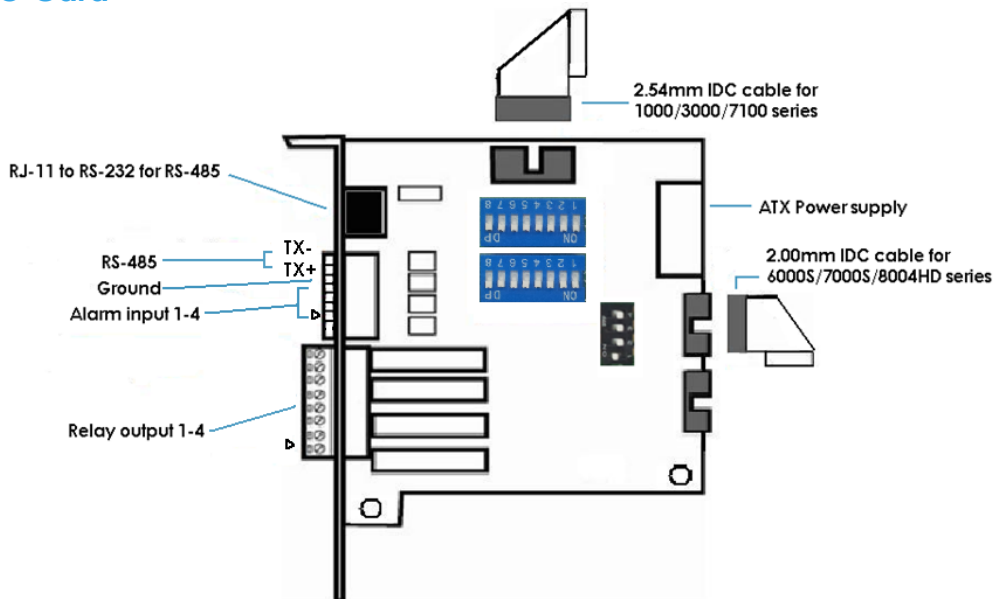

Note: Please do not connect 2 capture cards in one IO board at the same time.

G3-1000 Series Capture Card

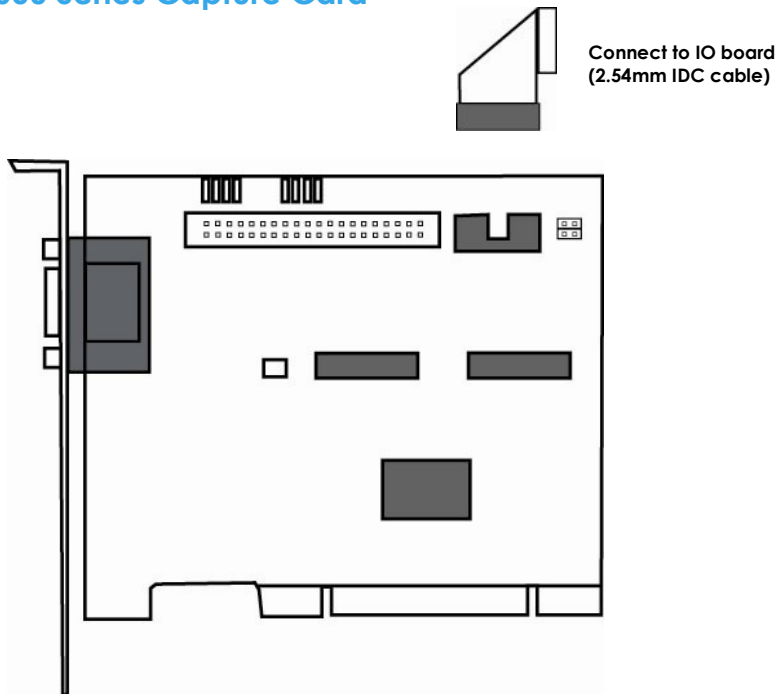

I/O Card

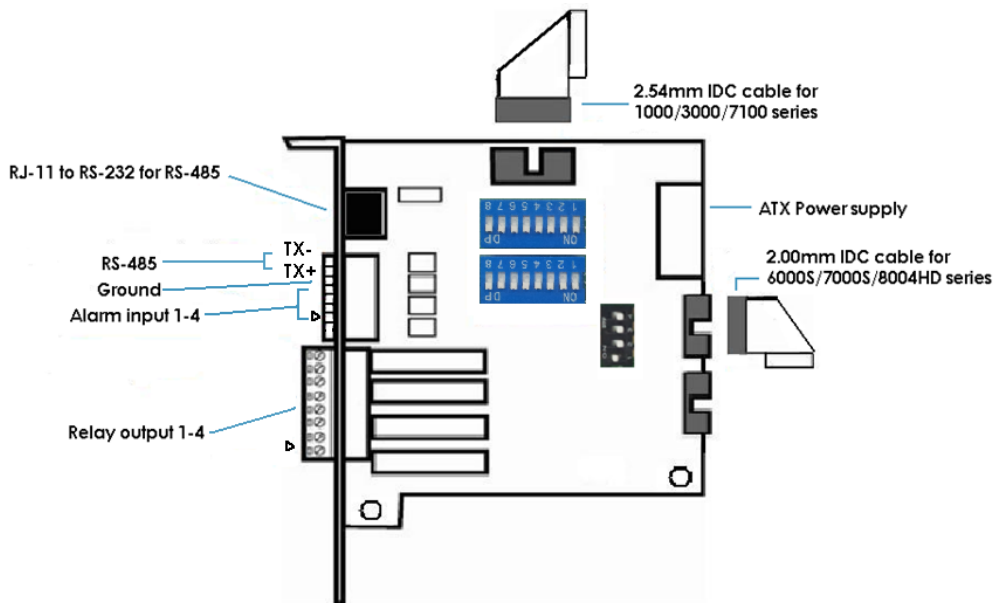

Note: Please do not connect 2 capture cards in one IO board at the same time.

G3-card Watchdog wire Installation

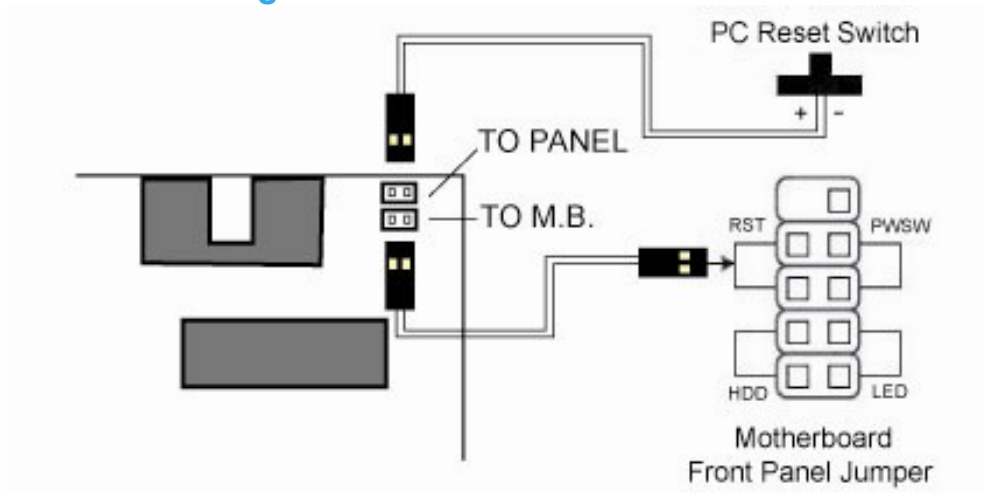

6000S/7000S SERIES Product Specification

Model	6016S	6008S	6004S
Display Rate	480fps(NTSC); 400fps (PAL)	240fps(NTSC); 200fps (PAL)	120fps(NTSC); 100fps (PAL)
Recording Rate (CIF)	480fps(NTSC); 400fps (PAL)	240fps(NTSC); 200fps (PAL)	120fps(NTSC); 100fps (PAL)
Maximum Card	4	4	4
Video Input	16	8	4
Audio Input	16	8	4
Video Resolution	NTSC: 176x120; 352x240; 704x480 PAL: 176x144; 352x288; 704x576		
Compression Format	Hardware Compression H.264		
	7016S	7008S	7004S
Display Rate	480fps(NTSC); 400fps (PAL)	240fps(NTSC); 200fps (PAL)	120fps(NTSC); 100fps (PAL)
Recording Rate (D1)	480fps(NTSC); 400fps (PAL)	240fps(NTSC); 200fps (PAL)	120fps(NTSC); 100fps (PAL)
Maximum Card	4	4	4
Video Input	16	8	4
Audio Input	16	8	4
Video Resolution	NTSC: 176x120; 352x240; 704x480 PAL: 176x144; 352x288; 704x576		
Compression Format	Hardware Compression H.264		

System Requirement

The system requirement depends on the number of camera connections and the total bit rate of the IP cameras. Please refer [Appendix - Minimum Hardware Requirement](#) or check NUUO Calculator on <http://support.nuuo.com/calculator/>

Caution



The electronic components within the unit are sensitive to damage from Electro-Static Discharge (ESD). Please take precautions at all times when handling the unit or its sub-assemblies.

Hardware Installation

Step 1: Insert the card onto an empty PCI-e slot. Connect the **Audio/Video Cable** to the connector.

Note 1: The audio input connectors are with red wires and marked of “A” on them (such as “A1/9”); the video input connectors are with black wires and marked of “V” (such as “V8/16”).

Note 2: You need to power down the PC before you insert the card.

Step 2: Connect the **Watchdog wire** to the **reset** connector on the main board.

Note: With the **Watchdog Wire** connected, the system will be restarted if any abnormal conditions.

Step 3: Turn on your PC and start Windows.

Step 3: Insert the included Software CD into CD-ROM.

Step 4: Refer the section Driver Installation on page 18 to install driver.

Step 5: After driver is installed, restart your PC.

Optional I/O Card: refer to the figures on the following pages.

Step 1: Fix the IO card onto your PC.

Step 2: Connect the Capture Card and the I/O Card with an included ribbon cable (**2.00mm** IDC cable).

Note 1: The default configuration of blue slide switch on I/O Card as below.

Note 2: If you only use one I/O card to connect with one of 6000S/7000S cards, please make sure the configuration of the black slide switch as below.

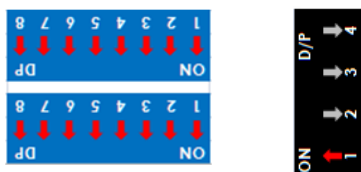

Maximum optional I/O Card support:

6000S/7000S can support maximum 4 I/O cards. Please refer to figures on the following pages.

6000S/7000S Series Capture Card

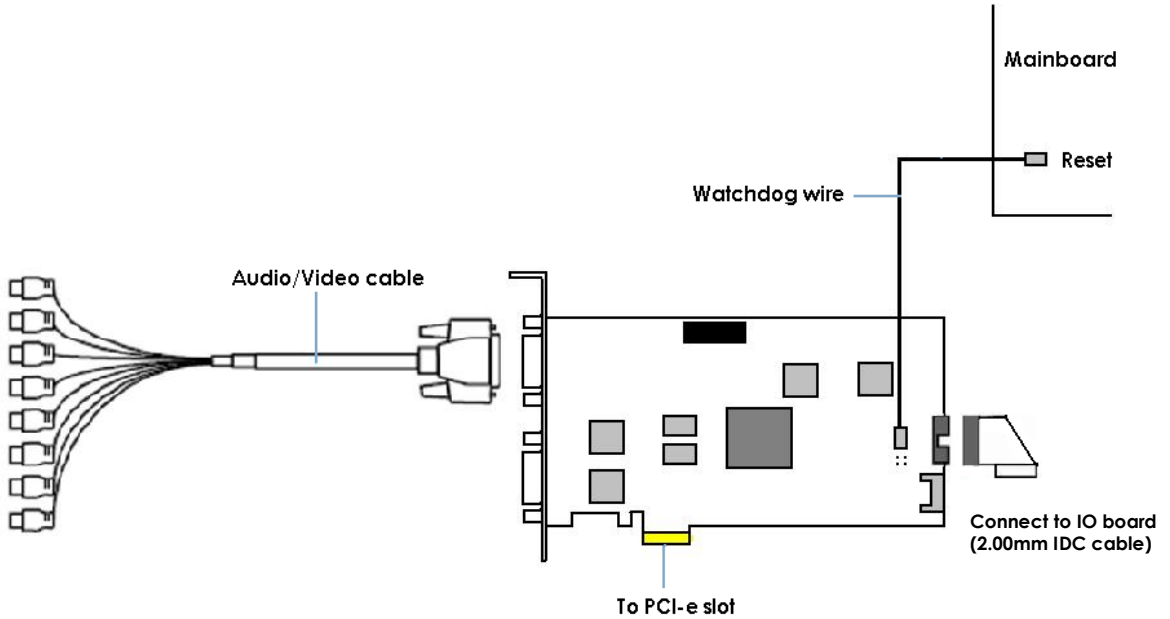

I/O card

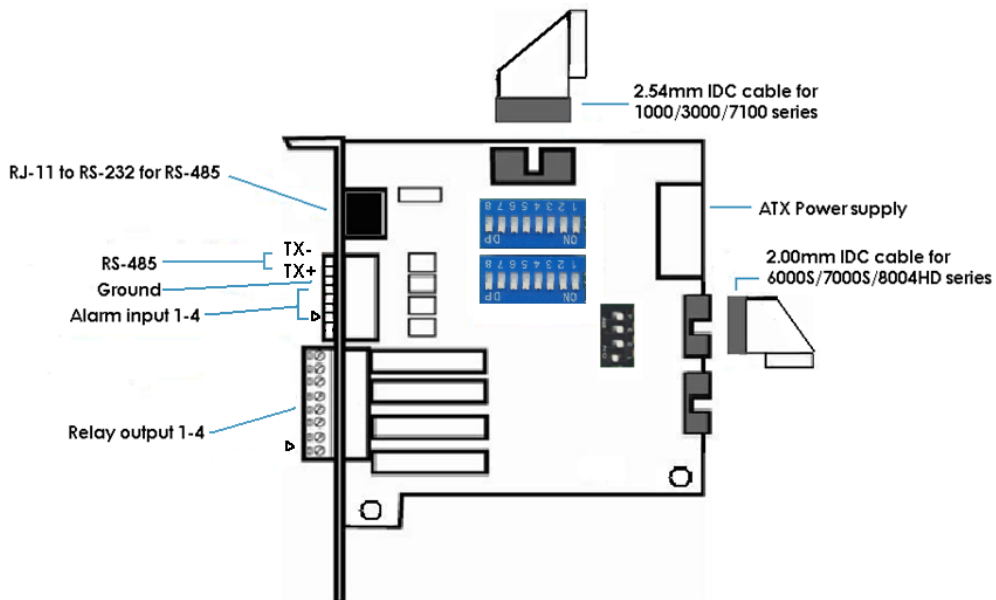

Note: Please do not connect 2 capture cards in one IO board at the same time.

Maximum I/O Cards support for 6000S/7000S

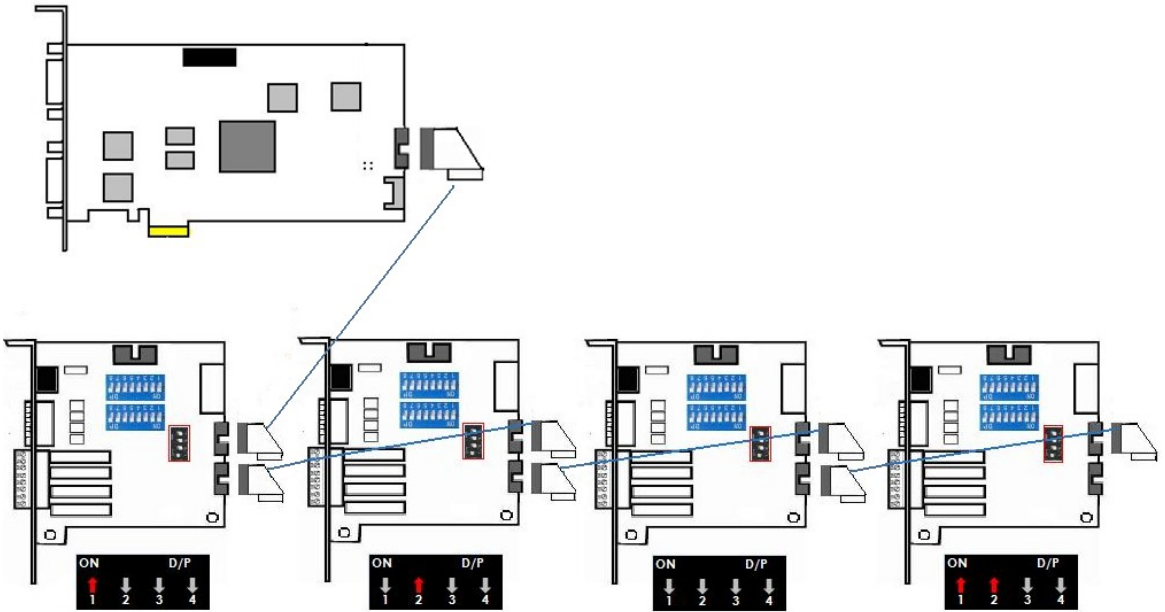

Note: If you use more than one IO card, please make sure the configuration of each black switch as above.

7100 SERIES Product Specification

	7116	7108
Display Rate	480fps(NTSC); 400fps (PAL)	240fps(NTSC); 200fps (PAL)
Recording Rate (D1)	480fps(NTSC); 400fps (PAL)	240fps(NTSC); 200fps (PAL)
Maximum Card	1	1
Video Input	16	8
Audio Input	16	8
Video Resolution	NTSC: 176x120; 352x240; 704x480 PAL: 176x144; 352x288; 704x576	
TV Output Rate	w/ HDMI: RCA & HDMI: 10fps w/o HDMI: RCA: 25fps Only HDMI: HDMI: 14fps	
Compression Format	Hardware Compression H.264	

System Requirement

The system requirement is depend on the number of camera connections and the total bit rate of the IP cameras. Please refer [Appendix - Minimum Hardware Requirement](#) or check NUUO Calculator on <http://support.nuuo.com/calculator/>

Caution



The electronic components within the unit are sensitive to damage from Electro-Static Discharge (ESD). Please take precautions at all times when handling the unit or its sub-assemblies.

Hardware Installation

Step 1: Insert the card onto an empty PCI-e slot. Connect the **Audio/Video Cable** to the connector.

Note 1: The audio input connectors are with red wires and marked of “A” on them (such as “A1/9”); the video input connectors are with black wires and marked of “V” (such as “V8/16”).

Note 2: You need to power down the PC before you insert the card.

Step 2: Connect the **Watchdog wire** to the **reset** connector on the main board.

Note: With the **Watchdog Wire** connected, the system will be restarted if any abnormal conditions.

Step 3: Turn on your PC and start Windows.

Step 3: Insert the included Software CD into CD-ROM.

Step 4: Refer the section Driver Installation on page 18 to install driver.

Step 5: After driver is installed, restart your PC.

Optional I/O Card: refer to the figures on the following pages.

Step 1: Fix the IO card onto your PC.

Step 2: Connect the Capture Card and the I/O Card with an included ribbon cable (**2.54mm** IDC cable).

Note 1: The default configuration of blue slide switch on I/O Card as below.

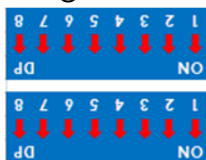

Note 2: Before install SCB-7100 Series cards, please connect HDMI cable first then it would be easier to fix the card onto the PCI-e slot.

Note 3: Some chassis may not be suitable for installing SCB-7100 series due to the original design, please check the dimension of the chassis before installing.

7100 Series Capture Card

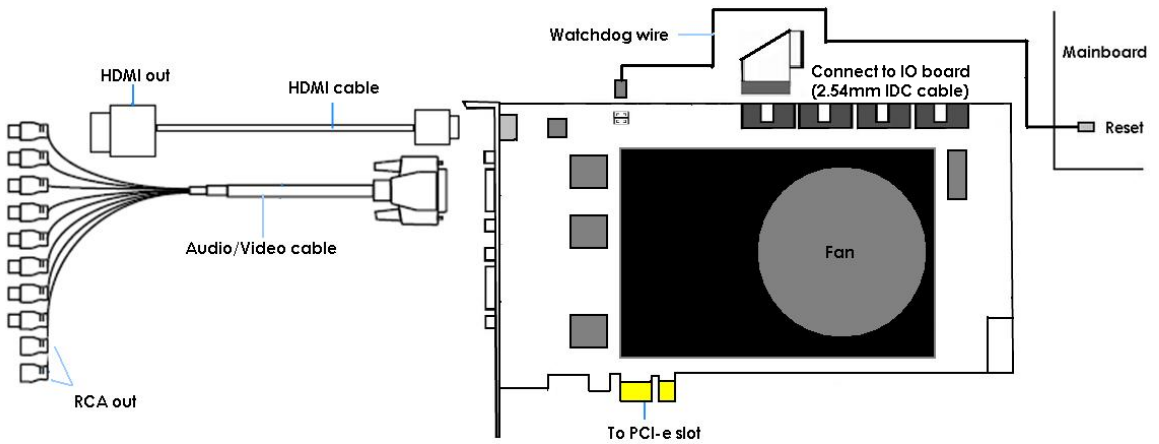

I/O card

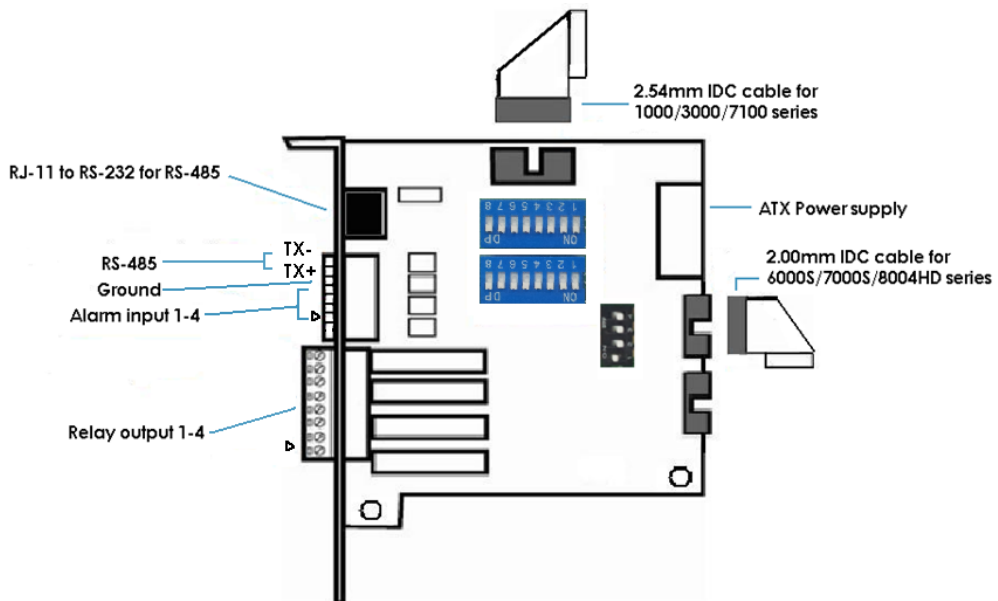

Maximum I/O Cards support for 7116

Please refer to page 5 [Maximum I/O Cards support for G3-3016](#)

8000HD SERIES Product Specification

8004HD	
Display Rate	120fps(NTSC); 100fps(PAL)
Recording Rate	1080P@120(NTSC) 1080P@100(PAL)
Maximum Card	2
Video Input	4
Audio Input	0
Video Resolution	1080P30/25 720P60/50/30/25
Compression Format	Hardware Compression H.264

System Requirement

The system requirement is depend on the number of camera connections and the total bit rate of the IP cameras. Please refer [Appendix - Minimum Hardware Requirement](#) or check NUUO Calculator on <http://support.nuuo.com/calculator/>

Caution



The electronic components within the unit are sensitive to damage from Electro-Static Discharge (ESD). Please take precautions at all times when handling the unit or its sub-assemblies.

Hardware Installation

Step 1: Insert the card onto an empty PCI-e slot. Connect the **BNC Cable** (not in product content) to the connector.

Note: You need to power down the PC before you insert the card.

Step 2: Connect the **Watchdog wire** to the **reset** connector on the main board.

Note: With the **Watchdog Wire** connected, the system will be restarted if any abnormal conditions.

Step 3: Turn on your PC and start Windows.

Step 3: Insert the included Software CD into CD-ROM.

Step 4: Refer the section Driver Installation on page 18 to install driver.

Step 5: After driver is installed, restart your PC.

Optional I/O Card: refer to the figures on the following pages.

Step 1: Fix the IO card onto your PC.

Step 2: Connect the Capture Card and the I/O Card with an included ribbon cable (**2.00mm** IDC cable).

Note 1: The default configuration of blue slide switch on I/O Card as below.

Note 2: If you only use one I/O card to connect with an 8004HD card, please make sure the configuration of the black slide switch as below.

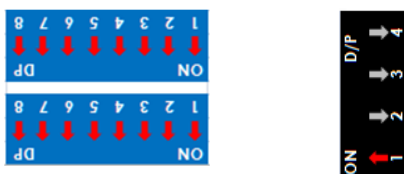

Maximum optional I/O Card support:

Please refer to page 11 [Maximum I/O Cards support for 6000S/7000S](#)

8004HD Card

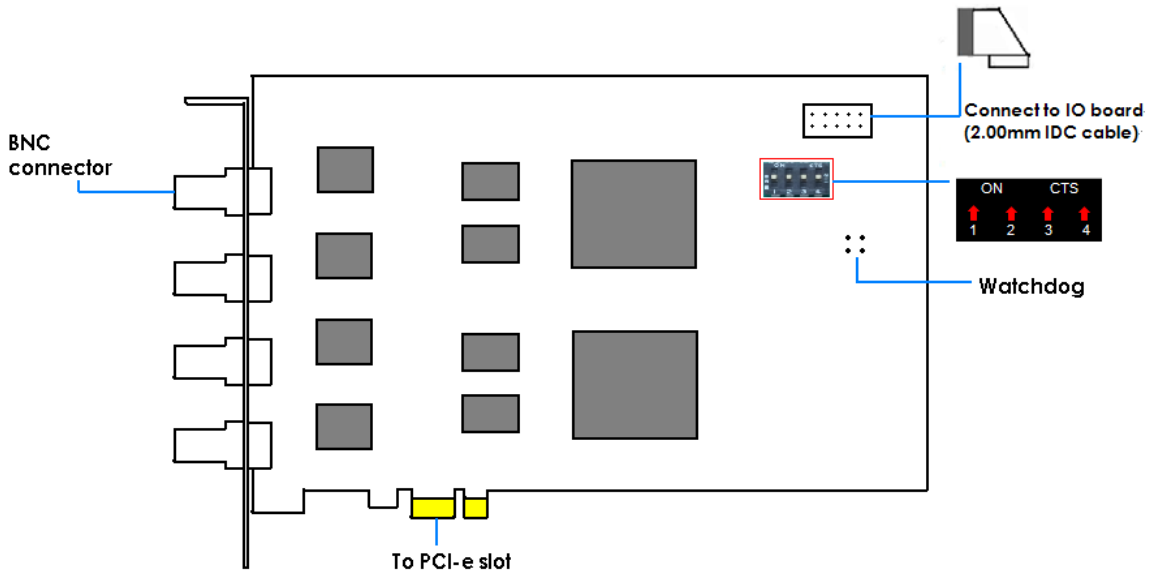

Note: The default configuration of the black switch on 8004HD card is as above. Do not adjust it.

I/O card

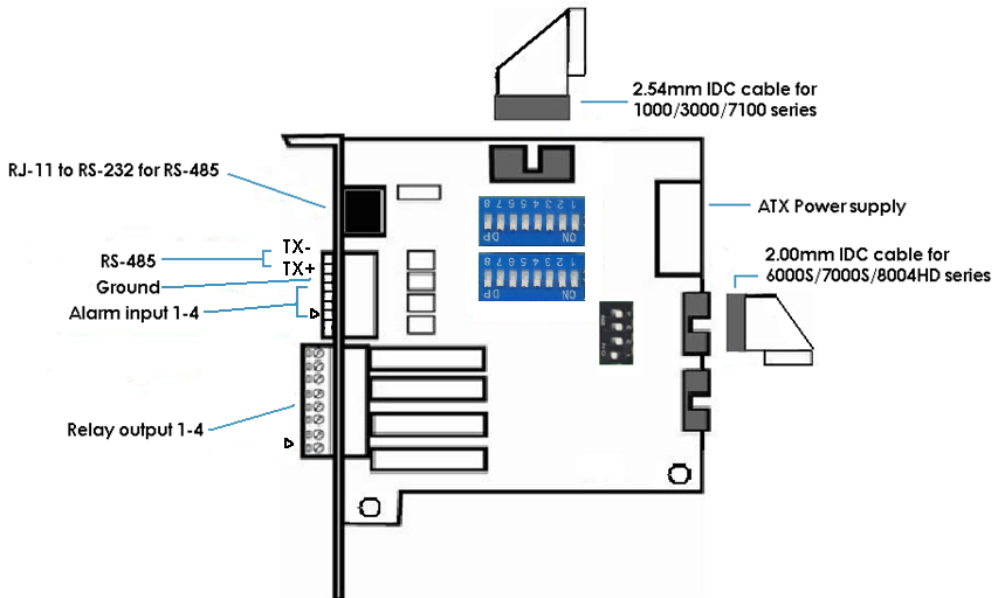

DRIVER INSTALLATION

Step 1: Insert the Installation CD. Run autostartup.exe  from the CD-ROM directly to start the installation.

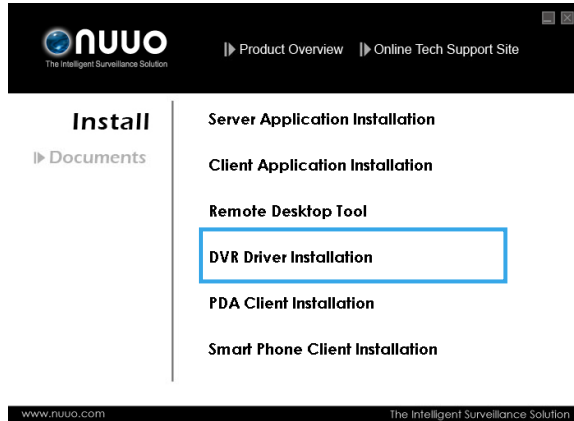

Step 2: Select "DVR Driver Installation" then click on it.

Step 3: In the NUUODriver Setup Wizard dialog box, click Next to continuous.



Step 4: Check the "License agreement". Click "I Agree" to continuous.

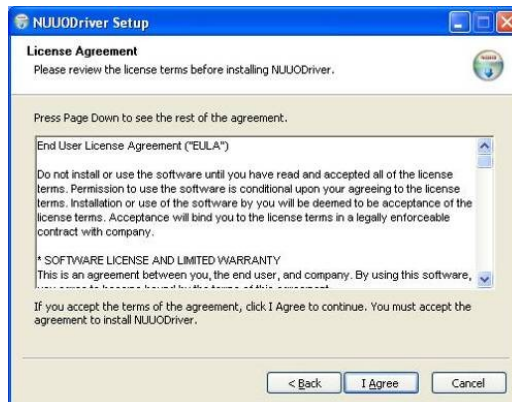

Step 5: Installing NUUODriver.

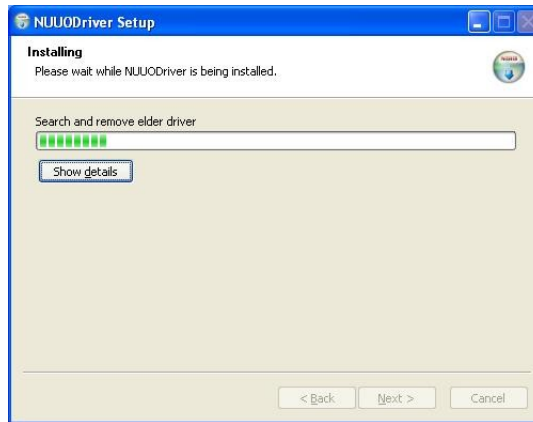

Step 6: Click "**Finish**" after installing the system completely, and then choose to reboot now or later.



SOFTWARE INSTALLATION

Step 1: Insert the Installation CD. Run Autorun Tool from the CD-ROM directly to start the installation.

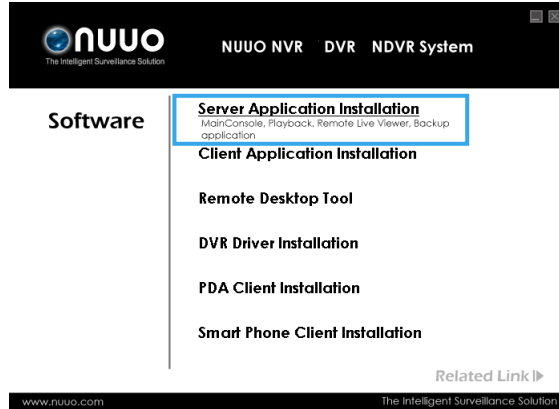

Step 2: Select "Server Application Installation" then click on it.

Step 3: There are 4 system types of options in "System Setup Tool" window, select one and click Next to start the installshield of Server package.

- NUUO IP Surveillance System/Trial System
- NUUO MPEG-4 Hybrid System
- NUUO Full HD/D1 H.264 Hybrid System

Note: The Setup Tool will detect the type of capture cards installs on PC and enable the options of system types automatically.

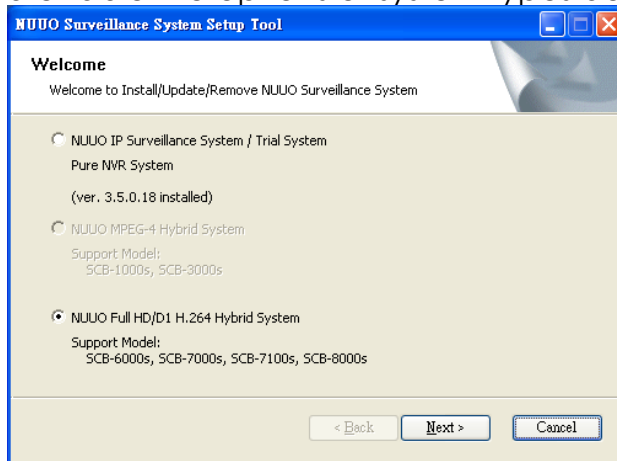

Step 4: In the InstallShield Wizard dialog box, click **Next** to continuous.

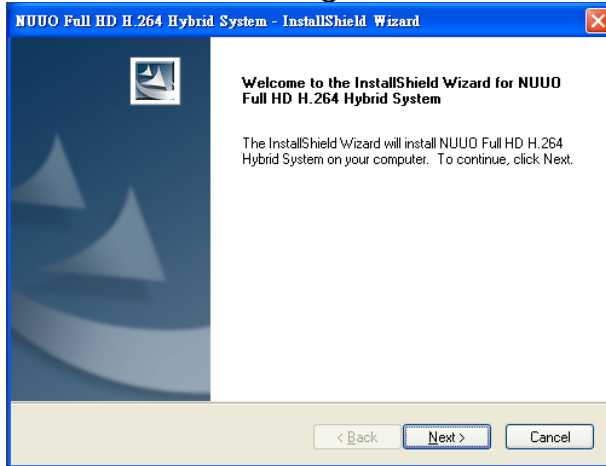

Step 5: Check the option "I accept the terms of the license agreement". Click **Next** to continuous.

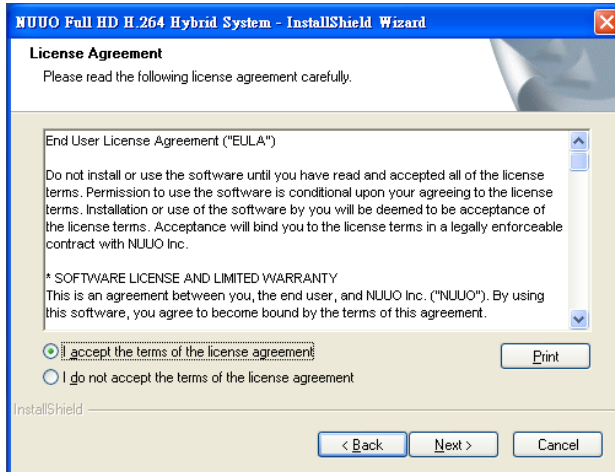

Step 6: Please enter your name and the company name for which you work. Click **Next** to continuous.

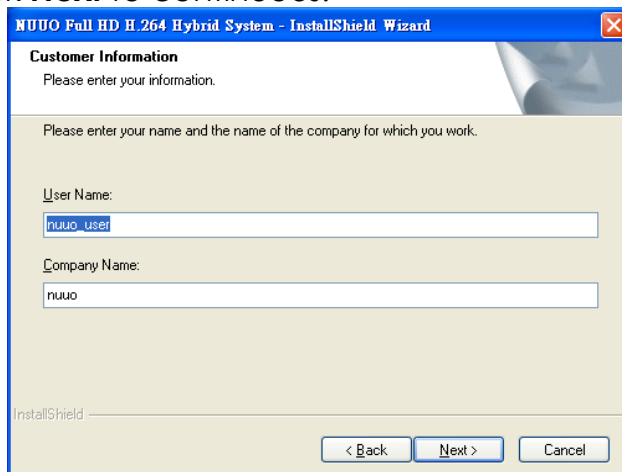

Step 7: Select “Complete Setup Type” or “Custom Setup Type” to install the System.

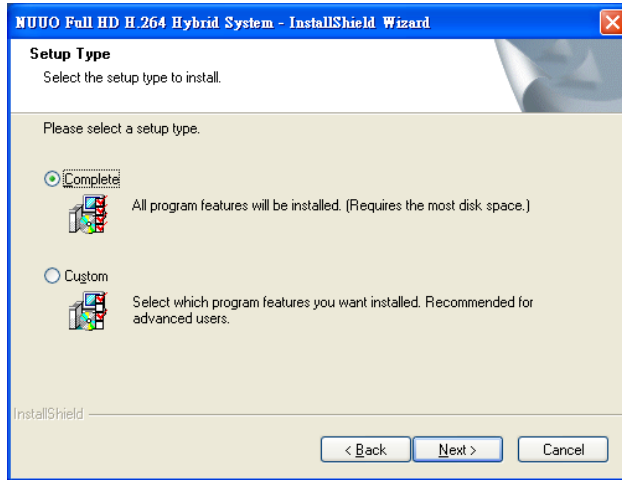

COMPLETE SETUP TYPE

Install all program features into the default directory.

- Check the option “**Complete**”, and then click “**Next**”. All program features will be installed. [Require the most disk space.]

CUSTOM SETUP TYPE

Install the system to a preferred directory. Or select whichever program feature(s) to install. This is recommended for advanced users.

- Check the option “**Custom**”, and then click “**Next**”.
- Select appointed folder where setup will install files to. Click “**Change**” to modify the installation directory.

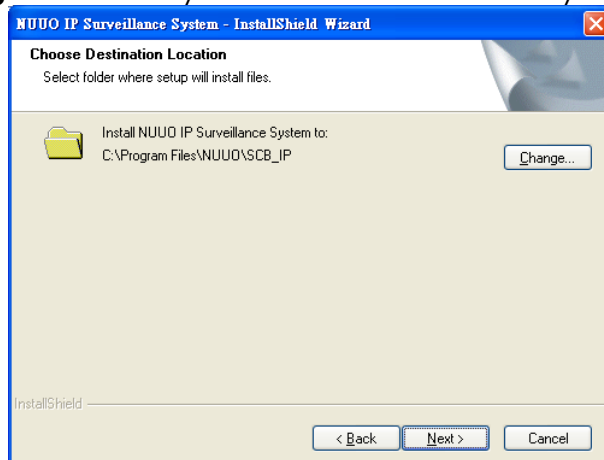

- Select the features setup will install. There are 4 features to choose in the server setup process: MainConsole, Playback, LiveView, Backup, and Verification tool. Click “**Next**” after confirmation.

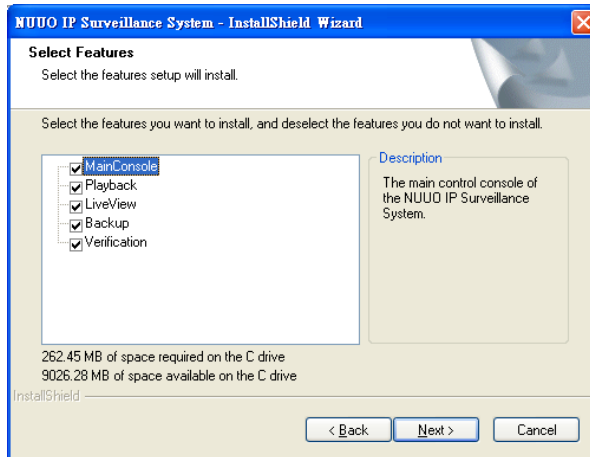

Step 8: Click install to start the installation.

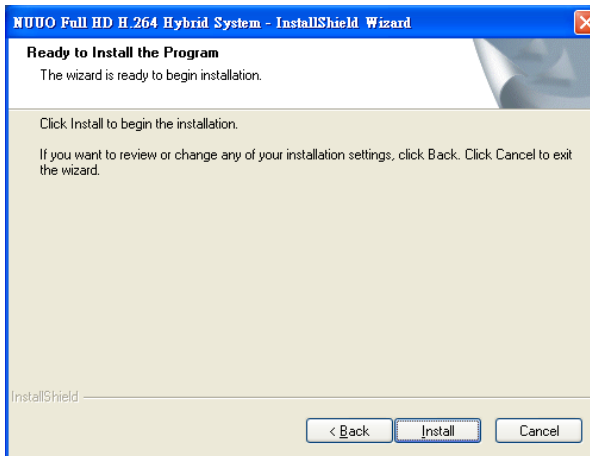

Step 9: Click Finish after installing the system completely.

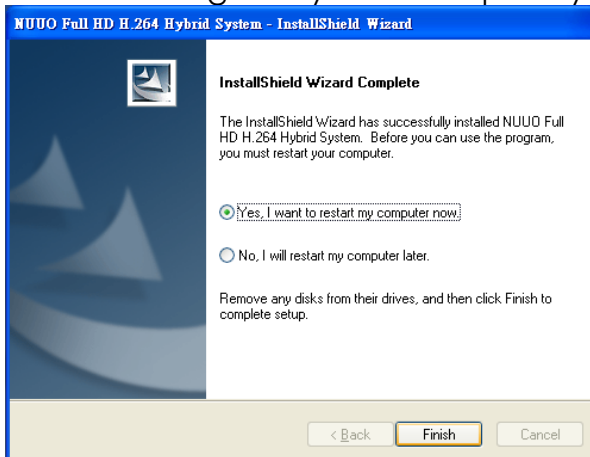

Step 10: Execute the Main Console

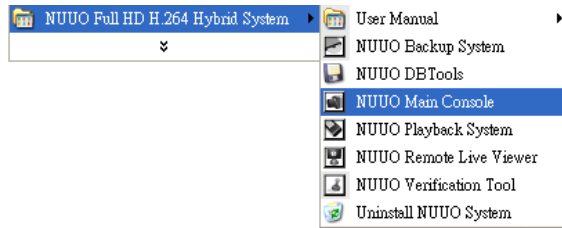

Step 11: Enter the password you like into the edit box and enter again at the edit of Password Confirm. And then press "OK". Now enjoy our Intelligent Surveillance Solution.

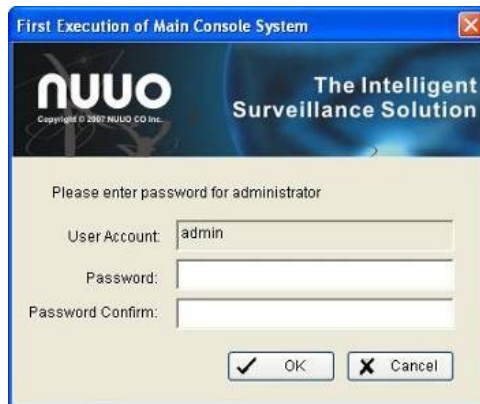

APPENDIX - MINIMUM HARDWARE REQUIREMENT

This document is to illustrate the hardware requirement for NUUO DVR, NVR, and hybrid system. The requirement specified in this document is the minimum requirement indicated for the desire system.

Note:

1. Different chipset for motherboard and display card may have slightly different effect.
2. For detail **Hardware Compatibility List**, please refer http://support.nuuo.com/mediawiki/index.php/Hardware_compatibility_list

H.264 Hardware Compression Card (SCB-8004HD/7100/7000S/6000S series)

	32 ch	16 ch	8 ch	4 ch
CPU	Intel Core 2 DuoE5300(6000S/7000S/8000HD series) Intel Core 2 QuadQ8400(7100 series)			
RAM	2 GB			
Motherboard	Intel P45 or P43 chip or above, MB vendor Asus, Gigabyte or MSI with Intel Chipset recommended			
Display card	ATI Radeon HD 4350 or above (ATI Driver V11-5 recommended ATI Driver V10 not support)			
Ethernet	100 baseT or above, gigabit LAN recommended			
Hard Disk	250 GB or above			
OS	Windows XP (32-bit) / Windows 7 (32 and 64-bit) / Windows 2008 (64-bit)			

MPEG-4 Software Compression Card (SCB-1000/3000 series)

	SCB-3000s x 2	SCB-3000s	SCB-1000
CPU	Intel Core 2 DuoE5300		
RAM	2 GB		
Motherboard	Intel P45 or P43 chip or above, MB vendor Asus, Gigabyte or MSI with Intel Chipset recommended		
Display card	ATI Radeon HD 4350 or above (ATI Driver V11-5 recommended ATI Driver V10 not support)		
Ethernet	100 baseT or above, gigabit LAN recommended		
Hard Disk	250 GB or above		
OS	Windows XP (32-bit) / Windows 7 (32 and 64-bit) / Windows 2008 (64-bit)		

Pure IP NVR

S of all cam.	D 2200~1400	C 1400~1050	B 1050~550	A 550~
CPU	Intel Core I7	Intel Core I5	Intel Core 2 Quad Q9400	Intel Core 2 Duo E5300
RAM	2 GB	2 GB	2 GB	1 GB
Motherboard	Intel 55 or 57 chip or above, MB vendor Asus, Gigabyte or Intel with Intel Chipset recommended		Intel 35 or 33 chip or above, MB vendor Asus, Gigabyte or Intel with Intel Chipset recommended	
Display card	ATI Radeon HD 4350 or above (ATI Driver V11-5 recommended ATI Driver V10 not support)			
Ethernet	100 baseT or above, Gigabit LAN recommended			
Hard Disk	250 GB or above			
OS	Windows XP (32-bit) / Windows 7 (32 and 64-bit) / Windows 2008 (64-bit)			

Parameter definitions:

S = M * N

M: parameter of resolution of IP camera

Resolution	5 M	3 M	2 M	1 M	VGA / D1	CIF
Value of M	37	27	22	14	3	1

N: FPS of Camera

For example: 8 channels system

- a) 1 camera at 1 Mega-pixel resolution with 10FPS
- b) 2 cameras at D1 resolution with 15FPS
- c) 5 cameras at CIF resolution with 30FPS

a) $M=14; N=10, S=14*10=140$

b) $M=3; N=15, S=3*15=45$

c) $M=1; N=30, S=1*30=30$

S of All Cam. = $1*140+2*45+5*30=380$

Therefore, the Minimum Hardware Requirement is **A level**.

Hybrid System

S of all cam.	D 2200~1400	C 1400~1050	B 1050~550	A 550~
CPU	Intel Core I7	Intel Core I5	Intel Core 2 Quad Q9400	Intel Core 2 Duo E5300
RAM	2 GB	2 GB	2 GB	1 GB
Motherboard	Intel 55 or 57 chip or above, MB vendor Asus, Gigabyte or Intel with Intel Chipset recommended		Intel 35 or 33 chip or above, MB vendor Asus, Gigabyte or Intel with Intel Chipset recommended	
Display card	ATI Radeon HD 4350 or above (ATI Driver V11-5 recommended ATI Driver V10 not support)			
Ethernet	100 baseT or above, Gigabit LAN recommended			
Hard Disk	250 GB or above			
OS	Windows XP (32-bit) / Windows 7 (32 and 64-bit) / Windows 2008 (64-bit)			

Parameter definitions:

$$S = M * N + P$$

M: parameter of resolution of IP camera

Resolution	5 M	3 M	2 M	1 M	VGA / D1	CIF
Value of M	37	27	22	14	3	1

N: FPS of Camera

P: parameter of NUUO compression card

Card	SCB-3000	SCB-1000
Value of P	120	30

Card	SCB-7016	SCB-7008	SCB-7004
Value of P	480	240	120

For example: 16 channels system

- 1 camera at 1 Mega-pixel resolution with 10FPS
- 2 cameras at D1 resolution with 15FPS
- 5 cameras at CIF resolution with 30FPS
- 8 cameras with 2pcs SCB-5004

a) $M=14; N=10, S = 14*10=140$

b) $M=3; N=15, S = 3*15=45$

c) $M=1; N=30, S = 1*30=30$

d) $P=60$

S of All Cam. $= 1*140+2*45+5*30+2*60=500$

Therefore, the Minimum Hardware Requirement is **A level**.