



# CE EMC TEST REPORT

For  
**NUUO Inc.**

Product Name:	<b>Network Video Recorder</b>
Trademark:	<b>NUUO</b>
Model Number:	<b>NC-2xx0P NVC-2xx0P, (xx=00,02,04,06,08,10,12,14,16)</b>
Prepared For :	<b>NUUO Inc.</b>
Address:	B1, No. 207-1, Sec. 3, Beixin Rd., Xindian Dist., New Taipei City 231, Taiwan
Prepared By :	<b>Shenzhen BCTC Technology Co., Ltd.</b>
Address:	NO.101, Yousong Road, Longhua New District, Shenzhen, Guangdong P.R.China
Test Date:	<b>Oct. 29 - Nov. 05, 2015</b>
Date of Report :	<b>Nov. 05, 2015</b>
Report No.:	<b>BCTC-151013418</b>



## TABLE OF CONTENT

	Page
Test Report Declaration	
<b>1. GENERAL INFORMATION</b>	<b>6</b>
1.1 Description of Device (EUT)	6
1.2 Test Facility	6
1.3 Tested System Details	6
1.4 Test Uncertainty	7
<b>2. TEST INSTRUMENT USED</b>	<b>8</b>
2.1 For Conducted Emission Test	8
2.2 For Radiated Emission Test	8
2.3 For Harmonic & Flicker Test	9
2.4 For Electrostatic Discharge Immunity Test	9
2.5 For RF Field Strength Susceptibility Test	9
2.6 For Electrical Fast Transient /Burst Immunity Test	10
2.7 For Surge Test	10
2.8 For Injected Currents Susceptibility Test	10
2.9 For Magnetic Field Immunity Test	11
2.10 For Voltage Dips Interruptions Test	11
<b>3. POWER LINE CONDUCTED EMISSION TEST</b>	<b>12</b>
3.1 Block Diagram of Test Setup	12
3.2 Test Standard	12
3.3 Power Line Conducted Emission Limit	12
3.4 EUT Configuration on Test	12
3.5 Operating Condition of EUT	13
3.6 Test Procedure	13
3.7 Test Result	13
<b>4. RADIATION EMISSION TEST</b>	<b>16</b>
4.1 Block Diagram of Test Setup	16
4.2 Test Standard	16
4.3 Radiation Limit	17
4.4 EUT Configuration on Test	17
4.5 Operating Condition of EUT	17
4.6 Test Procedure	17
4.7 Test Result	18
<b>5. HARMONIC CURRENT EMISSION TEST</b>	<b>21</b>
5.1 Block Diagram of Test Setup	21
5.2 Test Standard	21
5.3 Operating Condition of EUT	21
5.4 Test Procedure	21
5.5 Test Results	21
<b>6. VOLTAGE FLUCTUATIONS &amp; FLICKER TEST</b>	<b>22</b>
6.1 Block Diagram of Test Setup	22
6.2 Test Standard	22
6.3 Operating Condition of EUT	22
6.4 Test Results	22



---

<b>7. ELECTROSTATIC DISCHARGE IMMUNITY TEST.....</b>	<b>23</b>
7.1 Block Diagram of Test Setup .....	23
7.2 Test Standard .....	23
7.3 Severity Levels and Performance Criterion .....	23
7.4 EUT Configuration.....	24
7.5 Operating Condition of EUT.....	24
7.6 Test Procedure.....	24
7.7 Test Results .....	25
<b>8. RF FIELD STRENGTH SUSCEPTIBILITY TEST .....</b>	<b>27</b>
8.1 Block Diagram of Test Setup .....	27
8.2 Test Standard .....	27
8.3 Severity Levels and Performance Criterion .....	28
8.4 Operating Condition of EUT.....	28
8.5 Test Procedure.....	28
8.6 Test Results .....	29
<b>9. ELECTRICAL FAST TRANSIENT/BURST IMMUNITY TEST.....</b>	<b>31</b>
9.1 Block Diagram of EUT Test Setup.....	31
9.2 Test Standard .....	31
9.3 Severity Levels and Performance Criterion .....	31
9.4 EUT Configuration on Test .....	32
9.5 Operating Condition of EUT.....	32
9.6 Test Procedure.....	32
9.7 Test Results .....	32
<b>10. SURGE TEST.....</b>	<b>33</b>
10.1 Block Diagram of EUT Test Setup.....	33
10.2 Test Standard .....	33
10.3 Severity Levels and Performance Criterion .....	33
10.4 EUT Configuration on Test .....	33
10.5 Operating Condition of EUT.....	34
10.6 Test Procedure.....	34
10.7 Test Result.....	34
<b>11. INJECTED CURRENTS SUSCEPTIBILITY TEST .....</b>	<b>35</b>
11.1 Block Diagram of EUT Test Setup.....	35
11.2 Test Standard .....	35
11.3 Severity Levels and Performance Criterion .....	35
11.4 EUT Configuration on Test .....	36
11.5 Operating Condition of EUT .....	36
11.6 Test Procedure.....	36
11.7 Test Result.....	37
<b>12. MAGNETIC FIELD IMMUNITY TEST.....</b>	<b>38</b>
12.1 Block Diagram of Test Setup .....	38
12.2 Test Standard .....	38
12.3 Severity Levels and Performance Criterion .....	38
12.4 EUT Configuration on Test .....	39
12.5 Operating Condition of EUT.....	39
12.6 Test Procedure.....	39
12.7 Test Results .....	39
<b>13. VOLTAGE DIPS AND INTERRUPTIONS TEST .....</b>	<b>41</b>
13.1 Block Diagram of EUT Test Setup.....	41
13.2 Test Standard .....	41
13.3 Severity Levels and Performance Criterion .....	41



13.4 EUT Configuration on Test .....	42
13.5 Operating Condition of EUT.....	42
13.6 Test Procedure.....	42
13.7 Test Result.....	42
<b>14. EUT PHOTOGRAPHS .....</b>	<b>43</b>
<b>15. EUT TEST PHOTOGRAPHS .....</b>	<b>46</b>



## TEST REPORT DECLARATION

Applicant : **NUUO Inc.**  
: B1, No. 207-1, Sec. 3, Beixin Rd., Xindian Dist., New Taipei City 231, Taiwan

Manufacturer : **SHENZHEN BAICHUAN SECURITY TECHNOLOGY CO.,LTD.**  
: 5th Floor, Building 7, Tangtou 3rd Industrial Area, Shiyan Town, Bao'an District, Shenzhen City, China

EUT : **Network Video Recorder**

Model Number : **NC-2xx0P**

Rating(s) : **Main unit: DC48V=== 2.5A**  
**External adaptor: Input: AC100-240V 50/60Hz 2.0A Max**  
**Output: DC48V=== 2.5A**

Test Procedure Used:

EMI : EN 55022 : 2010  
EN 61000-3-2 :2014, EN 61000-3-3 :2013

EMS : EN 55024 : 2010  
EN 61000-4-2 :2009, EN 61000-4-3 :2006+A1:2008+A2:2010,  
EN 61000-4-4 :2012, EN 61000-4-5 :2014,  
EN 61000-4-6 :2014, EN 61000-4-8 :2010, EN 61000-4-11 :2004

The device described above is tested by Shenzhen BCTC Technology Co., Ltd. to determine the maximum emission levels emanating from the device, the severe levels which the device can endure and EUT is performance criterion. The test results are contained in this test report. Shenzhen BCTC Technology Co., Ltd. is assumed of full responsibility for the accuracy and completeness of these tests. Also, this report shows that the EUT is technically compliant with the EN55022, EN61000-3-2, EN61000-3-3 and EN55024.

This report applies to above tested sample only and shall not be reproduced in part without written approval of Shenzhen BCTC Technology Co., Ltd.

Date of Test: Oct. 29 - Nov. 05, 2015 -----

Prepared by(Engineer): Sherry Yang -----

Reviewer(Quality Manager): Sophie Lu -----

Approved & Authorized Signer(Manager): Casey Wang -----





## 1. GENERAL INFORMATION

### 1.1 Description of Device (EUT)

EUT : **Network Video Recorder**

Model Number : **NC-2xx0P**

Power Supply : **Main unit: DC48V=== 2.5A**  
**External adaptor: Input: AC100-240V 50/60Hz 2.0A Max**  
**Output: DC48V=== 2.5A**

Applicant : **NUUO Inc.**

Address : **B1, No. 207-1, Sec. 3, Beixin Rd., Xindian Dist., New Taipei City 231, Taiwan**

Manufacturer : **SHENZHEN BAICHUAN SECURITY TECHNOLOGY CO.,LTD.**

Address : **5th Floor, Building 7, Tangtou 3rd Industrial Area, Shiyan Town, Bao'an District, Shenzhen City, China**

Date of report : **Nov. 05, 2015**

Date of Test : **Oct. 29 - Nov. 05, 2015**

### 1.2 Test Facility

#### Site Description

Name of Firm : **Shenzhen BCTC Technology Co., Ltd.**

Site Location : **NO.101, Yousong Road, Longhua New District, Shenzhen, Guangdong P.R.China**

### 1.3 Tested System Details

Host Personal Computer :	HP	Monitor :	SONY
M/N :	A1580TW	M/N :	MNT1
Printer :	EPSON STYLUS	Keyboard (USB) :	Genuine
M/N :	P320A	M/N :	N/A
Modem :	ACEEX	Mouse :	DETROIS
M/N :	DM-1414	M/N :	CM309



#### 1.4 Test Uncertainty

Conducted Emission Uncertainty :  $\pm 2.66\text{dB}$

Radiated Emission Uncertainty :  $\pm 4.26\text{dB}$



## 2. TEST INSTRUMENT USED

### 2.1 For Conducted Emission Test

Conducted Emission Test ( A --- site )					
Equipment	Manufacturer	Model#	Serial#	Last Cal.	Next Cal.
EMI Receiver	Rohde & Schwarz	ESHS30	828985/018	Aug. 25, 2015	Aug. 24, 2016
LISN	Kyoritsu	KNW407	8-1789-4	Aug. 25, 2015	Aug. 24, 2016
Spectrum Analyzer	ADVANTENT	R3132	160400093	Aug. 25, 2015	Aug. 24, 2016
50Ω coaxial switch	Anritsu	MP59B	6200264417	Aug. 25, 2015	Aug. 24, 2016
Pulse Limiter	R&S	ESH3-Z2	100681	Aug. 25, 2015	Aug. 24, 2016

### 2.2 For Radiated Emission Test

Radiation Emission Test (966 chamber)					
Equipment	Manufacturer	Model#	Serial#	Last Cal.	Next Cal.
Spectrum Analyzer	ADVANTENT	R3132	160400005	Aug. 25, 2015	Aug. 24, 2016
Amplifier	Tsj	MLA-10K-B01-27	1205323	Aug. 25, 2015	Aug. 24, 2016
Antenna	Schwarzbeck	VULB9160	9160-3206	Aug. 25, 2015	Aug. 24, 2016
EMI Receiver	Rohde & Schwarz	ESHS30	828985/018	Aug. 25, 2015	Aug. 24, 2016
Signal Generator	HP	8648A	3625U00573	Aug. 25, 2015	Aug. 24, 2016
50Ω coaxial switch	Anritsu	MP59B	6200264416	Aug. 25, 2015	Aug. 24, 2016





### 2.3 For Harmonic & Flicker Test

For Harmonic / Flicker Test ( A --- site )					
Equipment	Manufacturer	Model#	Serial#	Last Cal.	Next Cal.
Harmonic / Flicker Tester	Schaffner	CCN 1000-1	72472	Aug. 25, 2015	Aug. 24, 2016
Power source	Schaffner	NSG 1007-5-208-413	57227	Aug. 25, 2015	Aug. 24, 2016

### 2.4 For Electrostatic Discharge Immunity Test

For Electrostatic Discharge Immunity Test ( A --- site )					
Equipment	Manufacturer	Model#	Serial#	Last Cal.	Next Cal.
ESD Tester	HAEFELY	PSD 1600	H911'292	Aug. 25, 2015	Aug. 24, 2016

### 2.5 For RF Field Strength Susceptibility Test

For RF Field Strength Susceptibility Test ( A --- site )					
Equipment	Manufacturer	Model#	Serial#	Last Cal.	Next Cal.
Signal Generator	HP	8648A	3625U00573	Aug. 25, 2015	Aug. 24, 2016
Amplifier	A&R	500A100	17034	NCR	NCR
Amplifier	A&R	100W/1000M1	17028	NCR	NCR
Audio Analyzer (20Hz~1000K Hz)	Panasonic	2023B	202301/428	Aug. 25, 2015	Aug. 24, 2016
Isotropic Field Probe	A&R	FP2000	16755	Aug. 25, 2015	Aug. 24, 2016
Antenna	EMCO	3108	9507-2534	NCR	NCR
Log-periodic Antenna	A&R	AT1080	16812	NCR	NCR



## 2.6 For Electrical Fast Transient /Burst Immunity Test

For Electrical Fast Transient/Burst Immunity Test ( A --- site )					
Equipment	Manufacturer	Model#	Serial#	Last Cal.	Next Cal.
Burst Tester	HAEFELY	PEFT4010	080981-16	Aug. 25, 2015	Aug. 24, 2016
Coupling Clamp	HAEFELY	IP-4A	147147	Aug. 25, 2015	Aug. 24, 2016

## 2.7 For Surge Test

For Surge Test ( A --- site )					
Equipment	Manufacturer	Model#	Serial#	Last Cal.	Next Cal.
Surge Tester	HAEFELY	PSURGE4.1	080107-04	Aug. 25, 2015	Aug. 24, 2016

## 2.8 For Injected Currents Susceptibility Test

For Injected Currents Susceptibility Test ( A --- site )					
Equipment	Manufacturer	Model#	Serial#	Last Cal.	Next Cal.
Simulator	EMTEST	CWS500C	0900-12	Aug. 25, 2015	Aug. 24, 2016
CDN	EMTEST	CDN-M2	5100100100	Aug. 25, 2015	Aug. 24, 2016
VDN	EMTEST	CDN-M3	0900-11	Aug. 25, 2015	Aug. 24, 2016
Injection Clamp	EMTEST	F-2031-23MM	368	Aug. 25, 2015	Aug. 24, 2016
Attenuator	EMTEST	ATT6	0010222A	Aug. 25, 2015	Aug. 24, 2016



## 2.9 For Magnetic Field Immunity Test

For Magnetic Field Immunity Test ( A --- site )					
Equipment	Manufacturer	Model#	Serial#	Last Cal.	Next Cal.
Magnetic field generator	Schaffner	MFO6501	34299	Aug. 25, 2015	Aug. 24, 2016
Magnetic field loop antenna	Schaffner	INA702	148	Aug. 25, 2015	Aug. 24, 2016
MC2630	EM Test	MC2630	N/A	Aug. 25, 2015	Aug. 24, 2016
Magnetic	Coils EM Test	MS100	0500-19	Aug. 25, 2015	Aug. 24, 2016

## 2.10 For Voltage Dips Interruptions Test

For Voltage Dips Interruptions Test ( A --- site )					
Equipment	Manufacturer	Model#	Serial#	Last Cal.	Next Cal.
Dips Tester	HEAFELY	PLINE 1610	083732-18	Aug. 25, 2015	Aug. 24, 2016

### 3. POWER LINE CONDUCTED EMISSION TEST

#### 3.1 Block Diagram of Test Setup

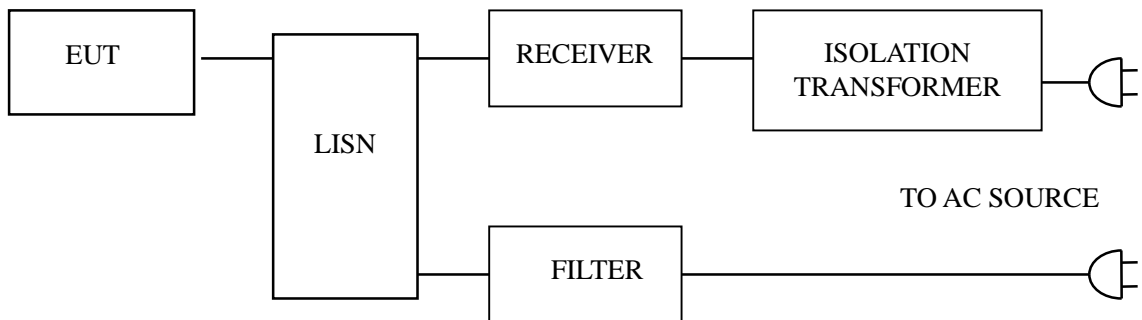

#### 3.2 Test Standard

EN 55022 : 2010

#### 3.3 Power Line Conducted Emission Limit

Frequency MHz	Limits dB(μV)	
	Quasi-peak Level	Average Level
0.15 ~ 0.50	66 ~ 56*	56 ~ 46*
0.50 ~ 5.00	56	46
5.00 ~ 30.00	60	50

Notes: 1. \*Decreasing linearly with logarithm of frequency.

2. The lower limit shall apply at the transition frequencies.

#### 3.4 EUT Configuration on Test

The following equipments are installed on conducted emission test to meet EN55022 requirement and operating in a manner which tends to maximize its emission characteristics in a normal application.

##### 3.4.1 Network Video Recorder (EUT)

Model Number : **NC-2xx0P**

Manufacturer : **SHENZHEN BAICHUAN SECURITY TECHNOLOGY CO.,LTD.**



### 3.5 Operating Condition of EUT

- 3.5.1 Setup the EUT and simulators as shown in Section 3.1.
- 3.5.2 Turn on the power of all equipments.
- 3.5.3 Let the EUT work in test modes (On) and test it.

### 3.6 Test Procedure

The EUT is put on the ground and connected to the AC mains through a Artificial Mains Network (AMN). This provided a 50ohm coupling impedance for the tested equipments. Both sides of AC line are checked to find out the maximum conducted emission levels according to the **EN55022** regulations during conducted emission test.

The bandwidth of the test receiver (R&S Test Receiver ESHS30) is set at 10KHz.

The frequency range from 150 KHz to 30 MHz is investigated.

### 3.7 Test Result

**PASS**

Please refer to the following page.

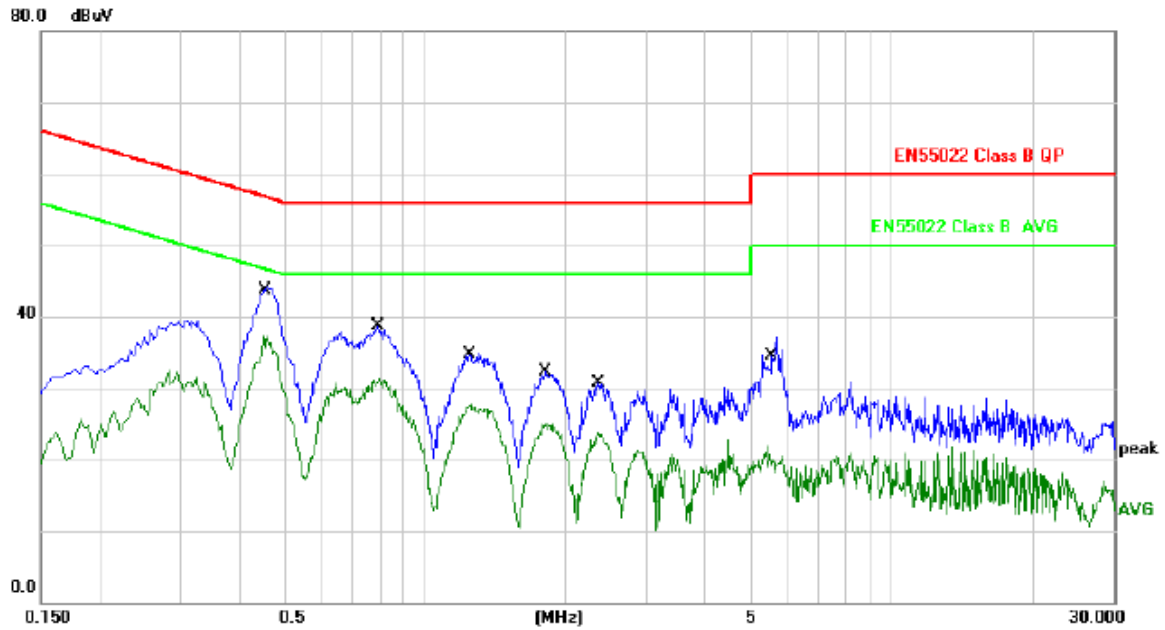

Site Chamber #1 Phase: **L1** Temperature: 24.5  
 Limit: EN55022 Class B QP Power: AC 230V/50Hz Humidity: 55 %

No.	Mk.	Freq. MHz	Reading Level dBuV	Correct Factor dB	Measure- ment dBuV	Limit dBuV	Over dB	Detector	Comment
1		0.4500	34.18	10.11	44.29	56.87	-12.58	QP	
2	*	0.4500	27.13	10.11	37.24	46.87	-9.63	AVG	
3		0.7940	28.48	10.14	38.62	56.00	-17.38	QP	
4		0.7940	21.21	10.14	31.35	46.00	-14.65	AVG	
5		1.2500	24.11	10.17	34.28	56.00	-21.72	QP	
6		1.2500	17.45	10.17	27.62	46.00	-18.38	AVG	
7		1.8180	22.04	10.18	32.22	56.00	-23.78	QP	
8		1.8180	14.94	10.18	25.12	46.00	-20.88	AVG	
9		2.3540	20.56	10.18	30.74	56.00	-25.26	QP	
10		2.3540	13.43	10.18	23.61	46.00	-22.39	AVG	
11		5.5739	26.98	10.12	37.10	60.00	-22.90	QP	
12		5.5739	9.74	10.12	19.86	50.00	-30.14	AVG	

\*:Maximum data x:Over limit !:over margin

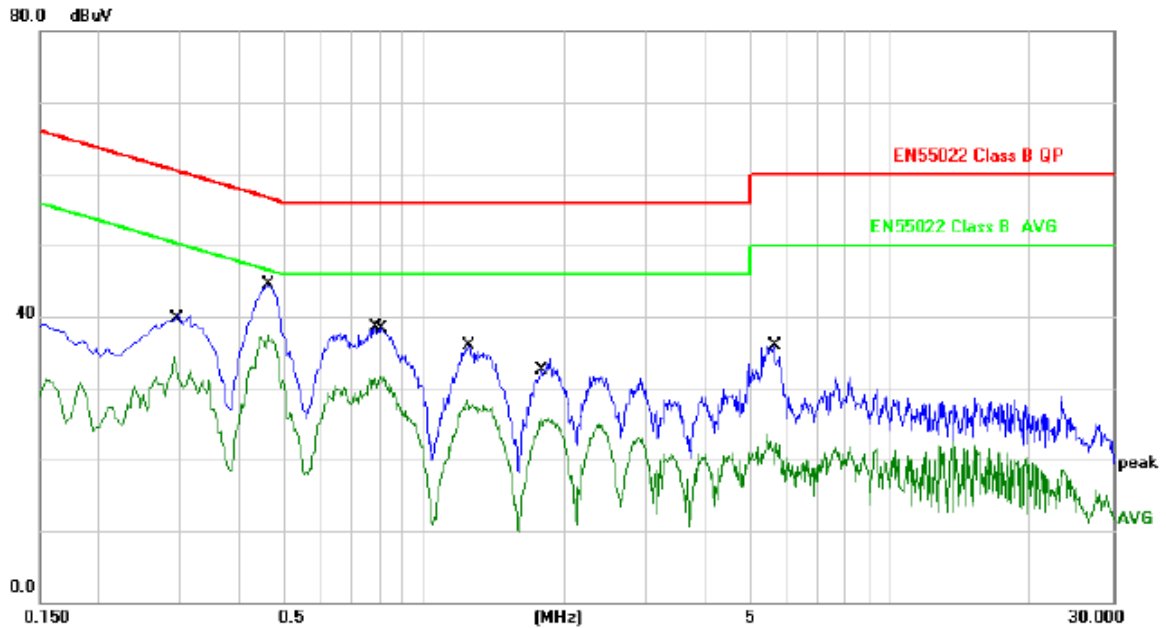

Site Chamber #1 Phase: **N** Temperature: 24.5  
 Limit: EN55022 Class B QP Power: AC 230V/50Hz Humidity: 55 %

No.	Mk.	Freq. MHz	Reading Level dBuV	Correct Factor dB	Measure- ment dBuV	Limit dBuV	Over dB	Detector	Comment
1		0.2900	30.22	10.09	40.31	60.52	-20.21	QP	
2		0.2900	24.16	10.09	34.25	50.52	-16.27	AVG	
3		0.4620	34.31	10.11	44.42	56.66	-12.24	QP	
4	*	0.4620	27.45	10.11	37.56	46.66	-9.10	AVG	
5		0.7860	28.28	10.14	38.42	56.00	-17.58	QP	
6		0.8059	21.49	10.15	31.64	46.00	-14.36	AVG	
7		1.2420	25.67	10.17	35.84	56.00	-20.16	QP	
8		1.2420	18.22	10.17	28.39	46.00	-17.61	AVG	
9		1.7900	22.39	10.18	32.57	56.00	-23.43	QP	
10		1.7900	15.54	10.18	25.72	46.00	-20.28	AVG	
11		5.6300	25.81	10.11	35.92	60.00	-24.08	QP	
12		5.6300	12.10	10.11	22.21	50.00	-27.79	AVG	

\*:Maximum data x:Over limit !:over margin

## 4. RADIATION EMISSION TEST

### 4.1 Block Diagram of Test Setup

#### 4.1.1. Block Diagram of EUT Test Setup

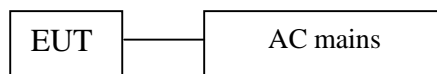

#### 4.1.2. Anechoic Chamber Setup Diagram

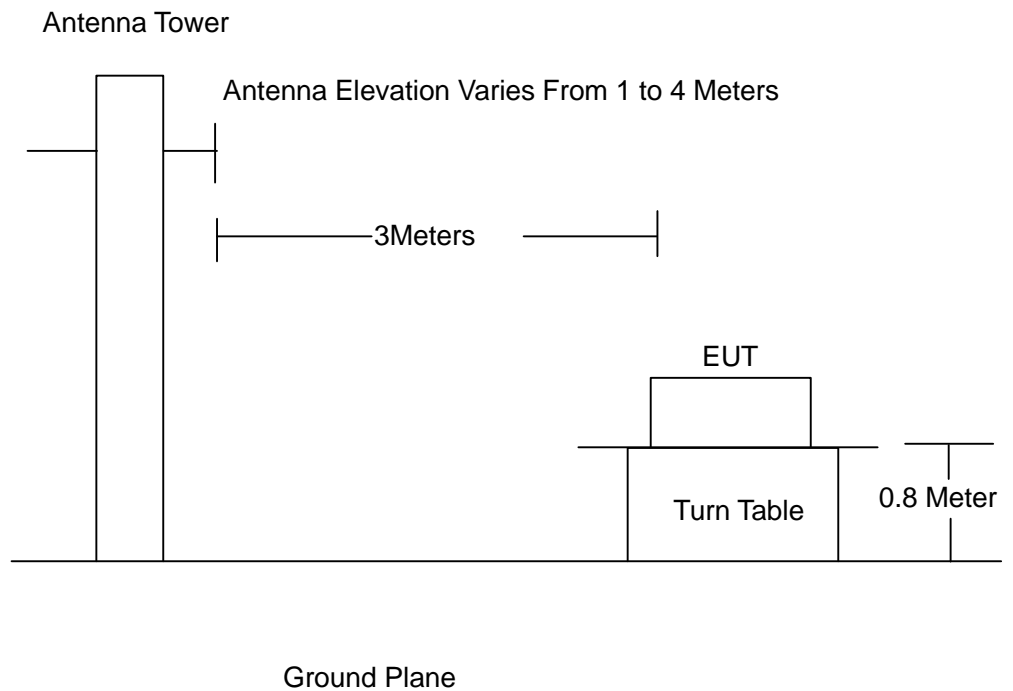

### 4.2 Test Standard

EN 55022 : 2010





### 4.3 Radiation Limit

Frequency MHz	Distance (Meters)	Field Strengths Limits dB( $\mu$ V)/m
30 ~ 230	3	40.0
230 ~ 1000	3	47.0

Remark:

- (1) Emission level (dB( $\mu$ V)/m) = 20 log Emission level ( $\mu$ V/m)
- (2) The smaller limit shall apply at the cross point between two frequency bands.
- (3) Distance refers to the distance in meters between the measuring instrument, antenna and the closed point of any part of the device or system.

### 4.4 EUT Configuration on Test

The EN55022 regulations test method must be used to find the maximum emission during radiated emission test.

The configuration of EUT is the same as used in conducted emission test.

Please refer to Section 2.2.

### 4.5 Operating Condition of EUT

Same as conducted emission test, which is listed in Section 2.2 except the test set up replaced as Section 4.1.

### 4.6 Test Procedure

The EUT and its simulators are placed on a turned table that is 0.8 meter above the ground. The turned table can rotate 360 degrees to determine the position of the maximum emission level. The EUT is set 3 meters away from the receiving antenna that is mounted on the antenna tower. The antenna can move up and down between 1 meter and 4 meters to find out the maximum emission level. Broadband antenna (calibrated biconical and log periodical antenna) is used as receiving antenna. Both horizontal and vertical polarization of the antenna is set on test. In order to find the maximum emission levels, the interface cable must be manipulated according to EN55022 on radiated emission test.

The bandwidth setting on the field strength meter (R&S Test Receiver ESHS30) is set at 120KHz.

The frequency range from 30MHz to 1000MHz is checked.



#### 4.7 Test Result

PASS

Please refer to the following page.

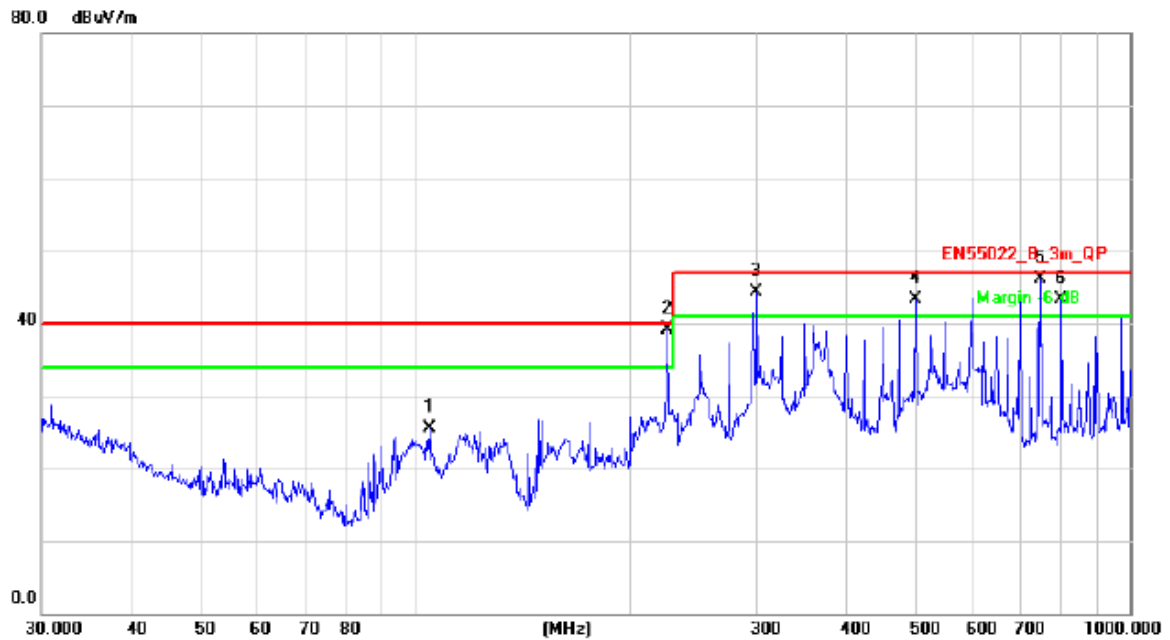

Site 966 BCTC Chamber #1

Polarization: *Horizontal*

Temperature: 24.5

Limit: EN55022\_B\_3m\_QP

Power: AC 230V/50Hz

Humidity: 55 %

No.	Mk.	Freq.	Reading Level	Correct Factor	Measurement	Limit	Over	Antenna Height	Table Degree	
		MHz	dBuV	dB/m	dBuV/m	dBuV/m	dB	cm	degree	Comment
1		104.9033	41.49	-16.02	25.47	40.00	-14.53			QP
2	!	225.3080	54.43	-15.32	39.11	40.00	-0.89			QP
3	!	300.3672	56.88	-12.57	44.31	47.00	-2.69			QP
4	!	501.1790	51.42	-8.19	43.23	47.00	-3.77			QP
5	*	750.1083	49.57	-3.38	46.19	47.00	-0.81			QP
6	!	801.7863	45.87	-2.49	43.38	47.00	-3.62			QP

\*:Maximum data    x:Over limit    !:over margin

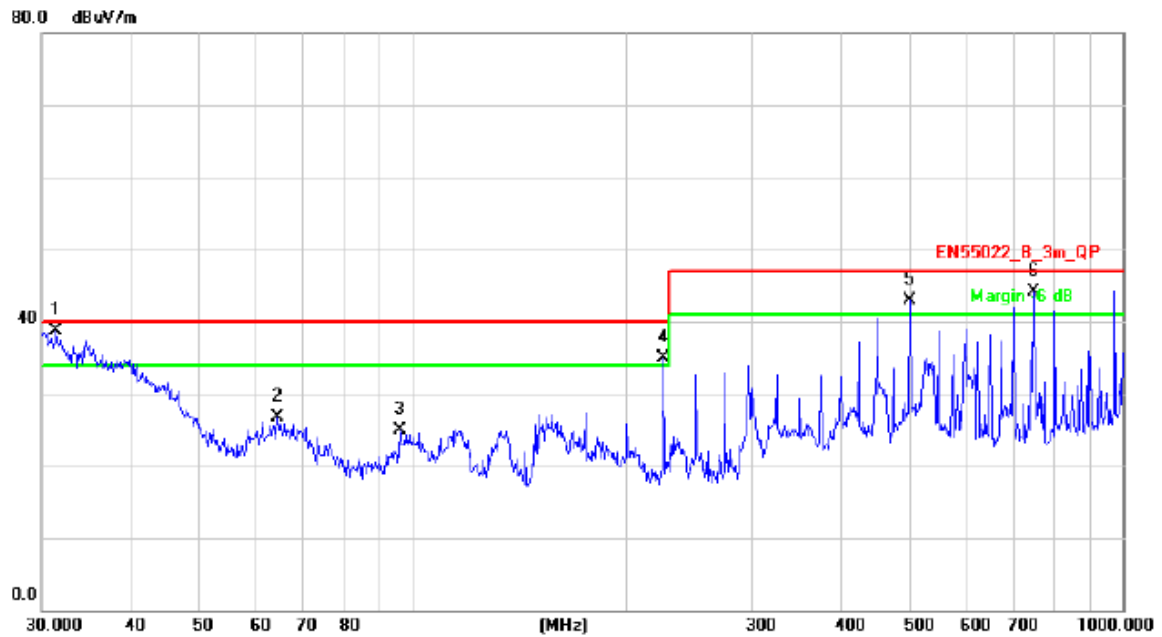

Site 966 BCTC Chamber #1  
Limit: EN55022\_B\_3m\_QP

Polarization: *Vertical*  
Power: AC 230V/50Hz

Temperature: 24.5  
Humidity: 55 %

No.	Mk.	Freq. MHz	Reading Level dBuV	Correct Factor dB/m	Measure- ment dBuV/m	Limit dBuV/m	Over dB	Antenna Height cm	Table Degree degree	Comment
1	*	31.3992	46.91	-8.22	38.69	40.00	-1.31	QP		
2		64.4330	39.03	-12.40	26.63	40.00	-13.37	QP		
3		95.7622	41.84	-16.93	24.91	40.00	-15.09	QP		
4	!	225.3079	50.31	-15.32	34.99	40.00	-5.01	QP		
5	!	501.1789	51.15	-8.19	42.96	47.00	-4.04	QP		
6	!	750.1082	47.24	-3.04	44.20	47.00	-2.80	QP		

\*:Maximum data    x:Over limit    !:over margin

## 5. HARMONIC CURRENT EMISSION TEST

### 5.1 Block Diagram of Test Setup

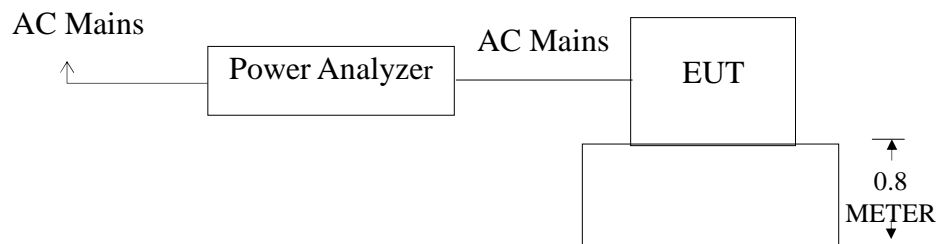

(EUT: Network Video Recorder )

### 5.2 Test Standard

EN 61000-3-2:2014

### 5.3 Operating Condition of EUT

- 5.3.1 Setup the EUT as shown in Section 5.1.
- 5.3.2 Turn on the power of all equipments.
- 5.3.3 Let the EUT work in test mode (ON) and test it.

### 5.4 Test Procedure

The power cord of the EUT is connected to the output of the test system. Turn on the power of the EUT and use the test system to test the harmonic current level.

### 5.5 Test Results

PASS



## 6. VOLTAGE FLUCTUATIONS & FLICKER TEST

### 6.1 Block Diagram of Test Setup

Same as Section 5.1..

### 6.2 Test Standard

EN 61000-3-3:2013

### 6.3 Operating Condition of EUT

Same as Section 5.3.. The power cord of the EUT is connected to the output of the test system. Turn on the power of the EUT and use the test system to test the harmonic current level.

#### Flicker Test Limit

Test items	Limits
Pst	1.0
dc	3.3%
dmax	4.0%
dt	Not exceed 3.3% for 500ms

### 6.4 Test Results

PASS

## 7. ELECTROSTATIC DISCHARGE IMMUNITY TEST

### 7.1 Block Diagram of Test Setup

#### 7.1.1. Block Diagram of the EUT and the simulators

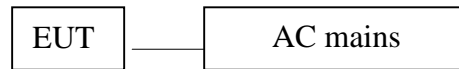

#### 7.1.2. Test Setup



### 7.2 Test Standard

EN 55024:2010, EN 61000-4-2:2009

Severity Level: 3 / Air Discharge:  $\pm 8\text{KV}$

Level: 2 / Contact Discharge:  $\pm 4\text{KV}$

### 7.3 Severity Levels and Performance Criterion

#### 7.3.1 Severity level

Level	Test Voltage Contact Discharge (KV)	Test Voltage Air Discharge (KV)
1.	$\pm 2$	$\pm 2$
2.	$\pm 4$	$\pm 4$
3.	$\pm 6$	$\pm 8$
4.	$\pm 8$	$\pm 15$
X	Special	Special

#### 7.3.2 Performance criterion : B



- A.** The apparatus shall continue to operate as intended during and after the test. No degradation of performance or loss of function is allowed below a performance level specified by the manufacturer, when the apparatus is used as intended.
  
- B.** The apparatus shall continue to operate as intended after the test. No degradation of performance or loss of function is allowed below a performance level specified by the manufacturer, when the apparatus is used as intended. The performance level may be replaced by a permissible loss of performance. During the test, degradation of performance is however allowed.
  
- C.** Temporary loss of function is allowed, provided the function is self-recoverable or can be restored by the operation of the controls.

#### 7.4 EUT Configuration

The following equipments are installed on Electrostatic Discharge Immunity test to meet EN 55024:2010, EN 61000-4-2:2009, requirement and operating in a manner which tends to maximize its emission characteristics in a normal application. The configuration of EUT is the same as used in conducted emission test. Please refer to Section 2.4.

#### 7.5 Operating Condition of EUT

Same as conducted emission measurement, which is listed in Section 3.5 except the test setup replaced by Section 7.1.2.

#### 7.6 Test Procedure

##### 7.6.1 Air Discharge:

This test is done on a non-conductive surface. The round discharge tip of the discharge electrode shall be approached as fast as possible to touch the EUT. After each discharge, the discharge electrode shall be removed from the EUT. The generator is then re-triggered for a new single discharge and repeated 10 times for each pre-selected test point. This procedure shall be repeated until all the air discharge completed.

##### 7.6.2 Contact Discharge:

All the procedure shall be same as Section 7.6.1. Except that the tip of the discharge electrode shall touch the EUT before the discharge switch is operated.





#### 7.6.3 Indirect discharge for horizontal coupling plane

At least 10 single discharges (in the most sensitive polarity) shall be applied at the front edge of each HCP opposite the center point of each unit (if applicable) of the EUT and 0.1m from the front of the EUT. The long axis of the discharge electrode shall be in the plane of the HCP and perpendicular to its front edge during the discharge.

#### 7.6.4 Indirect discharge for vertical coupling plane

At least 10 single discharges (in the most sensitive polarity) shall be applied to the center of one vertical edge of the coupling plane. The coupling plane, of dimensions 0.5m X 0.5m, is placed parallel to, and positioned at a distance of 0.1m from the EUT. Discharges shall be applied to the coupling plane, with this plane in sufficient different positions that the four faces of the EUT are complete illuminated.

### 7.7 Test Results

**PASS**

Please refer to the following page.



## Electrostatic Discharge Test Results

Shenzhen BCTC Technology Co., Ltd.

Applicant	: NUUO Inc.	Test Date	: Nov. 05, 2015	
EUT	: Network Video Recorder	Temperature:	25°C	
M/N	: NC-2xx0P	Humidity	: 53%	
Power Supply	: AC230V			
Test Engineer	: Snowy Yang			
Air Discharge: ± 8KV				
Contact Discharge: ± 4KV # For each point positive 25 times and negative 25 times discharge				
Test Points	Air Discharge	Contact Discharge	Performance Criterion	Result
Others Slot of the EUT	±8KV	N/A	B	PASS
COVER	N/A	±4 KV	B	PASS
PORT	N/A	±4 KV	B	PASS
SCREW	N/A	±4 KV	B	PASS
BUTTON	±8KV	N/A	B	PASS
VCP	N/A	±4 KV	B	PASS
HCP	N/A	±4 KV	B	PASS

## 8. RF FIELD STRENGTH SUSCEPTIBILITY TEST

### 8.1 Block Diagram of Test Setup

#### 8.1.1. Block Diagram of the EUT and the simulators



#### 8.1.2. R/S Test Setup

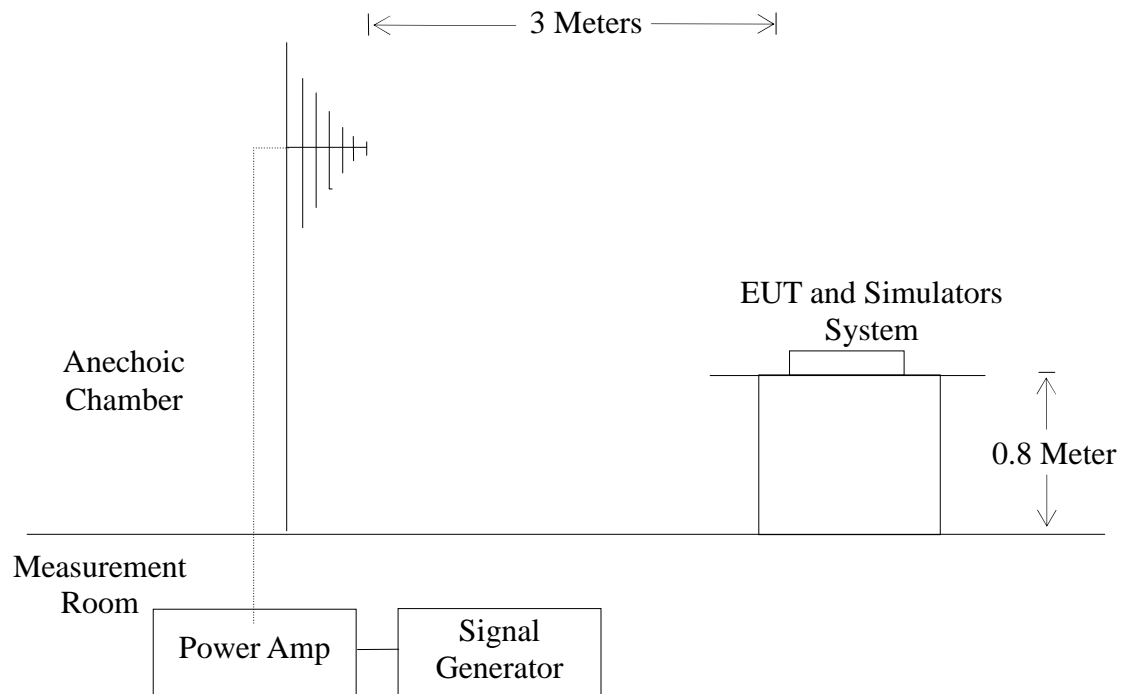

### 8.2 Test Standard

EN 55024:2010, EN 61000-4-3: 2006+A1:2008+A2:2010  
Severity Level 2, 3V / m



### 8.3 Severity Levels and Performance Criterion

#### 8.3.1. Severity level

Level	Field Strength V/m
1.	1
2.	3
3.	10
X.	Special

#### 8.3.2. Performance criterion: A

- A、 The apparatus shall continue to operate as intended during and after the test. No degradation of performance or loss of function is allowed below a performance level specified by the manufacturer, when the apparatus is used as intended.
- B、 The apparatus shall continue to operate as intended after the test. No degradation of performance or loss of function is allowed below a performance level specified by the manufacturer, when the apparatus is used as intended. The performance level may be replaced by a permissible loss of performance. During the test, degradation of performance is however allowed.
- C、 Temporary loss of function is allowed, provided the function is self-recoverable or can be restored by the operation of the controls.

### 8.4 Operating Condition of EUT

Same as conducted emission measurement, which is listed in Section 2.5 except the test setup replaced by Section 8.1.

### 8.5 Test Procedure

The EUT and its simulators are placed on a turn table which is 0.8 meter above ground. EUT is set 3 meter away from the transmitting antenna which is mounted on an antenna tower. Both horizontal and vertical polarization of the antenna are set on test. Each of the four sides of EUT must be faced this transmitting antenna and measured individually.



All the scanning conditions are as follows :

Condition of Test	Remarks
1. Fielded Strength	3 V/m (Severity Level 2)
2. Radiated Signal	Modulated
3. Scanning Frequency	80 – 1000 MHz
4. Dwell time of radiated	0.0015 decade/s
5. Waiting Time	1 Sec.

## 8.6 Test Results

**PASS**

Please refer to the following page.



## RF Field Strength Susceptibility Test Results

Shenzhen BCTC Technology Co., Ltd.

Applicant: NUUO Inc.		Test Date : Nov. 05, 2015	
EUT : Network Video Recorder		Temperature : 25°C	
M/N : NC-2xx0P		Humidity : 53%	
Field Strength: 3 V/m		Criterion: A	
Power Supply: AC230V		Frequency Range: 80 MHz to 1000 MHz	
Test Engineer: Snowy Yang			
Modulation: <b>p</b> AM            .. Pulse            .. none    1 KHz    80%			
Test Mode : On			
		Frequency Range : 80-1000MHz	
Steps		1 %	
	Horizontal	Vertical	Result
Front	A	A	PASS
Right	A	A	PASS
Rear	A	A	PASS
Left	A	A	PASS

## 9. ELECTRICAL FAST TRANSIENT/BURST IMMUNITY TEST

### 9.1 Block Diagram of EUT Test Setup

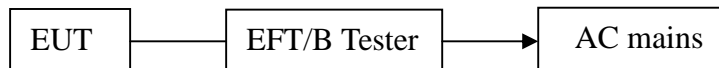

### 9.2 Test Standard

EN 55024:2010, EN 61000-4-4:2012

### 9.3 Severity Levels and Performance Criterion

Severity Level 2 at 1KV, Pulse Rise time & Duration: 5 nS / 50 nS

Severity Level:

Open Circuit Output Test Voltage $\pm 10\%$		
Level	On power ports	On I/O(Input/Output) Signal data and control ports
1.	0.5KV	0.25KV
2.	1KV	0.5KV
3.	2KV	1KV
4.	4KV	2KV
X.	Special	Special

#### Performance criterion: B

- A. The apparatus shall continue to operate as intended during and after the test. No degradation of performance or loss of function is allowed below a performance level specified by the manufacturer, when the apparatus is used as intended.
- B. The apparatus shall continue to operate as intended after the test. No degradation of performance or loss of function is allowed below a performance level specified by the manufacturer, when the apparatus is used as intended. The performance level may be replaced by a permissible loss of performance. During the test, degradation of performance is however allowed.
- C. Temporary loss of function is allowed, provided the function is self-recoverable or can be restored by the operation of the controls.



#### 9.4 EUT Configuration on Test

The following equipments are installed on Electrical Fast Transient/Burst Immunity test to meet EN 55024:2010, EN 61000-4-4:2012, requirement and operating in a manner which tends to maximize its emission characteristics in a normal application. The configuration of EUT is the same as used in conducted emission test.

Please refer to Section 3.4.

#### 9.5 Operating Condition of EUT

Same as conducted emission measurement, which is listed in Section 2.6 except the test setup replaced by Section 9.1.

#### 9.6 Test Procedure

EUT shall be placed 0.8m high above the ground reference plane which is a min.1m\*1m metallic sheet with 0.65mm minimum thickness. This reference ground plane shall project beyond the EUT by at least 0.1m on all sides and the minimum distance between EUT and all other conductive structure, except the ground plane beneath the EUT, shall be more than 0.5m

##### 9.6.1. For input and output AC power ports:

The EUT is connected to the power mains by using a coupling device which couples the EFT interference signal to AC power lines. Both polarities of the test voltage should be applied during compliance test and the duration of the test is 2 minutes.

##### 9.6.2. For signal lines and control lines ports:

It's unnecessary to measure.

##### 9.6.3. For AC input and DC output power ports:

For DC ports .It's unnecessary to measure

#### 9.7 Test Results

**PASS**

EUT:	Network Video Recorder	Temperature:	25°C
M/N:	NC-2xx0P	Humidity:	53%
Test Mode:	Working Mode	Test Engineer:	Snowy Yang

TEST VOLTAGE	L	N	L+N
±0.5KV	B	B	B
±1KV	B	B	B



## 10. SURGE TEST

### 10.1 Block Diagram of EUT Test Setup



### 10.2 Test Standard

EN 55024:2010, EN61000-4-5:2014

### 10.3 Severity Levels and Performance Criterion

Severity Level: Line to Line, Level 2 at 1KV;

Severity Level: Line to Earth, Level 3 at 2KV.

Severity Level	Open-Circuit Test Voltage (KV)
1.	0.5
2.	1.0
3.	2.0
4.	4.0
X.	Special

#### Performance criterion: B

- A. The apparatus shall continue to operate as intended during and after the test. No degradation of performance or loss of function is allowed below a performance level specified by the manufacturer, when the apparatus is used as intended.
- B. The apparatus shall continue to operate as intended after the test. No degradation of performance or loss of function is allowed below a performance level specified by the manufacturer, when the apparatus is used as intended. The performance level may be replaced by a permissible loss of performance. During the test, degradation of performance is however allowed.
- C. Temporary loss of function is allowed, provided the function is self-recoverable or can be restored by the operation of the controls.

### 10.4 EUT Configuration on Test

The following equipments are installed on Electrical Fast Transient/Burst Immunity test to meet EN 55024:2010, EN61000-4-5:2014, requirement and



operating in a manner which tends to maximize its emission characteristics in a normal application

The configuration of EUT is the same as used in conducted emission test. Please refer to Section 3.4.

## 10.5 Operating Condition of EUT

Same as conducted emission measurement, which is listed in Section 2.7 except the test setup replaced by Section 10.1.

## 10.6 Test Procedure

- 1) Set up the EUT and test generator as shown on section 10.1
- 2) For line to line coupling mode, provide a 1KV 1.2/50us voltage surge (at open-circuit condition) and 8/20us current surge to EUT selected points.
- 3) At least 5 positive and 5 negative (polarity) tests with a maximum 1/min repetition rate are conducted during test.
- 4) Different phase angles are done individually.
- 5) Repeat procedure 2) to 4) except the open-circuit test voltage change from 1KV to 2KV for line to earth coupling mode test.
- 6) Record the EUT operating situation during compliance test and decide the EUT immunity criterion for above each test.

## 10.7 Test Result

PASS

EUT:	Network Video Recorder	Temperature:	25°C
M/N:	NC-2xx0P	Humidity:	53%
Test Mode:	Working Mode	Test Engineer:	Snowy Yang

Location	Polarity	Phase Angle	No of Pulse	Pulse Voltage (KV)	Performance Criterion	Result
L-N	±	0	5	1	B	PASS
	±	90	5	1	B	PASS
	±	180	5	1	B	PASS
	±	270	5	1	B	PASS

# 11. INJECTED CURRENTS SUSCEPTIBILITY TEST

## 11.1 Block Diagram of EUT Test Setup

### 11.1.1. Block Diagram of EUT Test Setup



### 11.1.2. Block Diagram of Test Setup

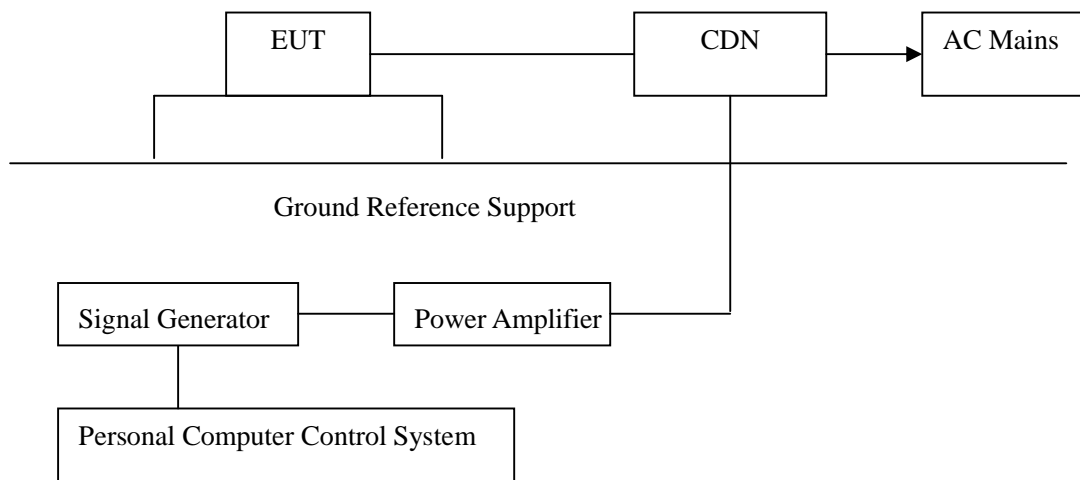

## 11.2 Test Standard

EN 55024:2010, EN61000-4-6:2014

## 11.3 Severity Levels and Performance Criterion

Severity Level 2: 3V( rms ), 150KHz ~ 80MHz

Severity Level:

Level	Field Strength V
1.	1
2.	3
3.	10
X.	Special



**Performance criterion: A**

- A. The apparatus shall continue to operate as intended during and after the test. No degradation of performance or loss of function is allowed below a performance level specified by the manufacturer, when the apparatus is used as intended.
- B. The apparatus shall continue to operate as intended after the test. No degradation of performance or loss of function is allowed below a performance level specified by the manufacturer, when the apparatus is used as intended. The performance level may be replaced by a permissible loss of performance. During the test, degradation of performance is however allowed.
- C. Temporary loss of function is allowed, provided the function is self-recoverable or can be restored by the operation of the controls.

#### 11.4 EUT Configuration on Test

The configuration of EUT is the same as used in conducted emission test. Please refer to Section 2.8.

#### 11.5 Operating Condition of EUT

Same as conducted emission test, which is listed in Section 2.8 except the test set up replaced as Section 11.1.

#### 11.6 Test Procedure

- 1) Set up the EUT, CDN and test generator as shown on section 11.1
- 2) Let EUT work in test mode and measure.
- 3) The EUT and supporting equipments are placed on an insulating support 0.1m high above a ground reference plane. CDN (coupling and decoupling device) is placed on the ground plane at above 0.1-0.3m from EUT. Cables between CDN and EUT are as short as possible, and their height above the ground reference plane shall be between 30 and 50 mm (where possible).
- 4) The disturbance signal described below is injected to EUT through CDN.
- 5) The EUT operates within its operational mode(s) under intended climatic conditions after power on.
- 6) The frequency range is swept from 150KHz to 80MHz using 3V signal level, and with the disturbance signal 80% amplitude modulated with a 1KHz sine wave



- 7) The rate of sweep shall not exceed  $1.5 \times 10^{-3}$  decades/s. Where the frequency is swept incrementally, the step size shall not exceed 1% of the start and thereafter 1% of the preceding frequency value.
- 8) Recording the EUT operating situation during compliance test and decide the EUT immunity criterion for above each test.

## 11.7 Test Result

PASS

EUT:	Network Video Recorder	Temperature:	25°C
M/N:	NC-2xx0P	Humidity:	53%
Test Mode:	Working Mode	Test Engineer:	Snowy Yang

Frequency Range(MHz)	Injected Position	Strength	Performance Criterion	Result
150KHz ~ 80MHz	AC Line	3V(rms), Unmodulated	A	PASS

## 12. MAGNETIC FIELD IMMUNITY TEST

### 12.1 Block Diagram of Test Setup

#### 12.1.1 Block Diagram of the EUT

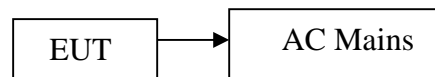

#### 12.1.2 Block Diagram of Test Setup

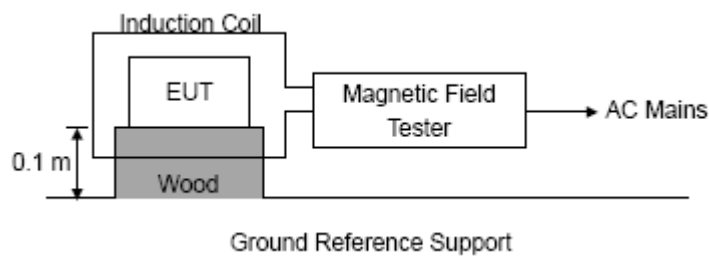

### 12.2 Test Standard

EN 55024:2010, EN61000-4-8:2010  
Severity Level 1 at 1A/m

### 12.3 Severity Levels and Performance Criterion

#### 12.3.1 Severity level

Level	Magnetic Field Strength A/m
1.	1
2.	3
3.	10
4.	30
5.	100
X.	Special



#### 12.3.2 Performance criterion: B

- A. The apparatus shall continue to operate as intended during and after the test. No degradation of performance or loss of function is allowed below a performance level specified by the manufacturer, when the apparatus is used as intended.
- B. The apparatus shall continue to operate as intended after the test. No degradation of performance or loss of function is allowed below a performance level specified by the manufacturer, when the apparatus is used as intended. The performance level may be replaced by a permissible loss of performance. During the test, degradation of performance is however allowed.
- C. Temporary loss of function is allowed, provided the function is self-recoverable or can be restored by the operation of the controls.

#### 12.4 EUT Configuration on Test

The configuration of EUT is listed in Section 2.9.

#### 12.5 Operating Condition of EUT

Same as conducted emission test, which is listed in Section 2.9 except the test set up replaced as Section 12.1.

#### 12.6 Test Procedure

The EUT shall be subjected to the test magnetic field by using the induction coil of standard dimensions (1m\*1m) and shown in Section 10.1. The induction coil shall then be rotated by 90° in order to expose the EUT to the test field with different orientations.

#### 12.7 Test Results

**PASS**

Please refer to the following page.



## Magnetic Field Immunity Test Results

Shenzhen BCTC Technology Co., Ltd.

EUT:	Network Video Recorder	Temperature:	25°C	
M/N:	NC-2xx0P	Humidity:	53%	
Test Mode:	Working Mode	Test Engineer:	Snowy Yang	
Environmental Phenomena	Test specification	Units	Performance Criterion	Result
Magnetic Field	1	A/m	A	PASS
Note: N/A				



## 13. VOLTAGE DIPS AND INTERRUPTIONS TEST

### 13.1 Block Diagram of EUT Test Setup



### 13.2 Test Standard

EN 55024:2010, EN61000-4-11:2004

### 13.3 Severity Levels and Performance Criterion

Severity Level:

Input and Output AC Power Ports.

**p** Voltage Dips.

**p** Voltage Interruptions.

Environmental Phenomena	Test Specification	Units	Performance Criterion
Voltage Dips	>95 0.5	% Reduction period	B
	30 25	% Reduction period	C
Voltage Interruptions	>95 250	% Reduction period	C

**Performance criterion: B, C, C**

- A. The apparatus shall continue to operate as intended during and after the test. No degradation of performance or loss of function is allowed below a performance level specified by the manufacturer, when the apparatus is used as intended.
- B. The apparatus shall continue to operate as intended after the test. No degradation of performance or loss of function is allowed below a performance level specified by the manufacturer, when the apparatus is used



as intended. The performance level may be replaced by a permissible loss of performance. During the test, degradation of performance is however allowed.

- C. Temporary loss of function is allowed, provided the function is self-recoverable or can be restored by the operation of the controls.

### 13.4 EUT Configuration on Test

The configuration of EUT is the same as used in conducted emission test. Please refer to Section 2.10.

### 13.5 Operating Condition of EUT

Same as conducted emission test, which is listed in Section 2.10 except the test set up replaced as Section 13.1.

### 13.6 Test Procedure

- 1) Set up the EUT and test generator as shown on section 13.1
- 2) The interruption is introduced at selected phase angles with specified duration. There is a 3mins minimum interval between each test event.
- 3) After each test a full functional check is performed before the next test.
- 4) Repeat procedures 2 & 3 for voltage dips, only the level and duration is changed.
- 5) Record any degradation of performance.

### 13.7 Test Result

**PASS**

EUT:	Network Video Recorder	Temperature:	25°C
M/N:	NC-2xx0P	Humidity:	53%
Test Mode:	Working Mode	Test Engineer:	Snowy Yang

Environmental Phenomena	Test Specification	Units	Performance Criterion
Voltage Dips	>95 0.5	% Reduction period	B
	30 25	% Reduction period	C
Voltage Interruptions	>95 250	% Reduction period	C

## 14. EUT PHOTOGRAPHS

**EUT Photo 1**



**EUT Photo 2**

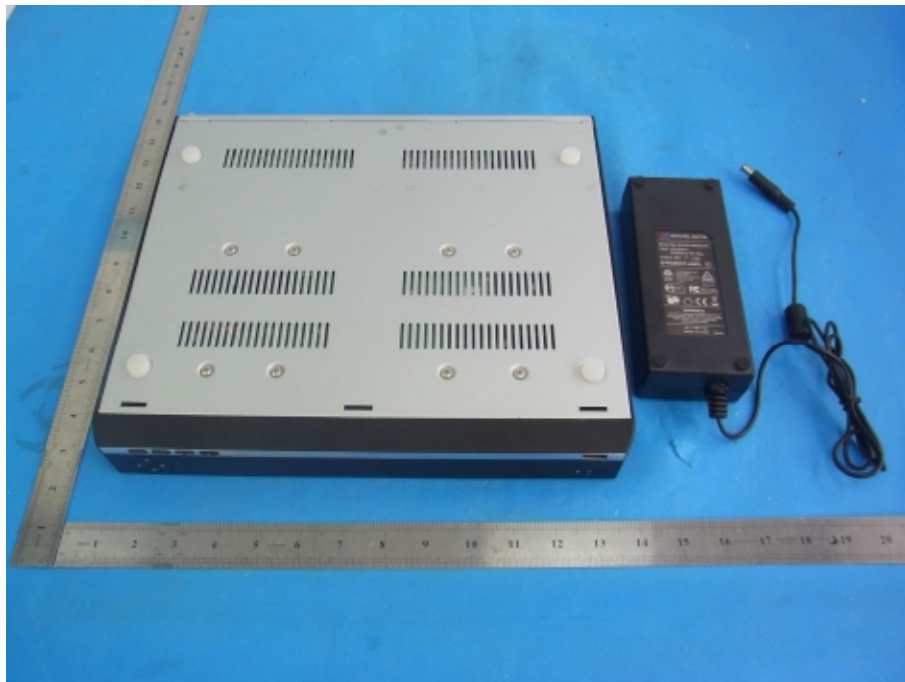

**EUT Photo 3**



**EUT Photo 4**





**EUT Photo 5**



**EUT Photo 6**

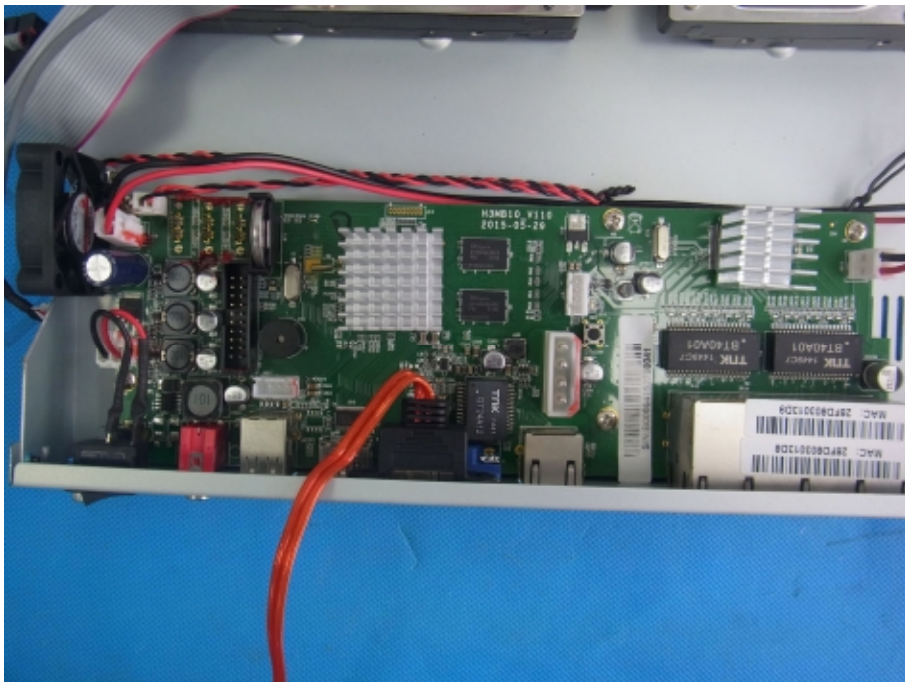

## 15. EUT TEST PHOTOGRAPHS

RE

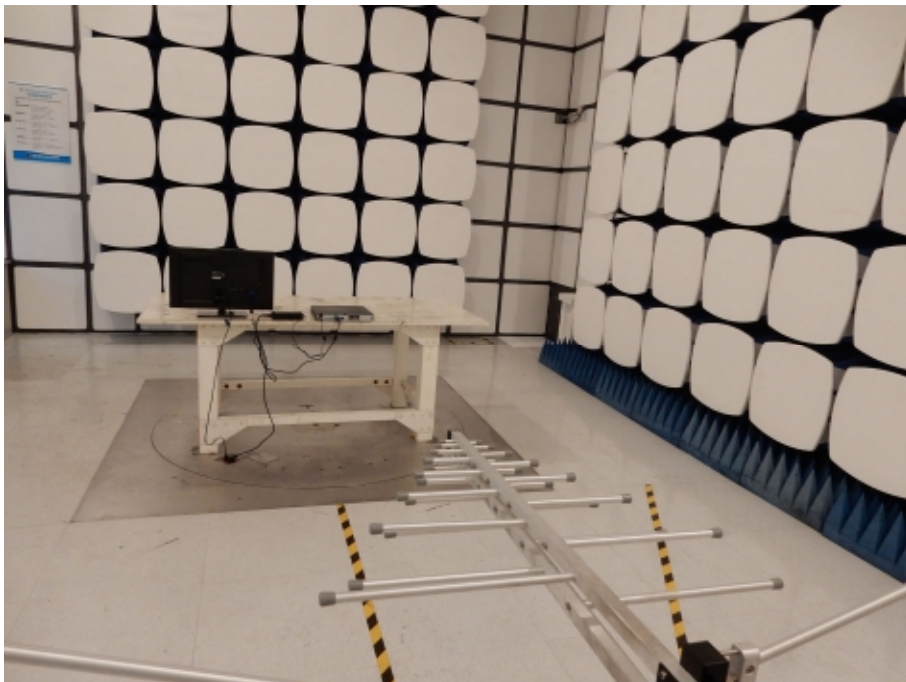
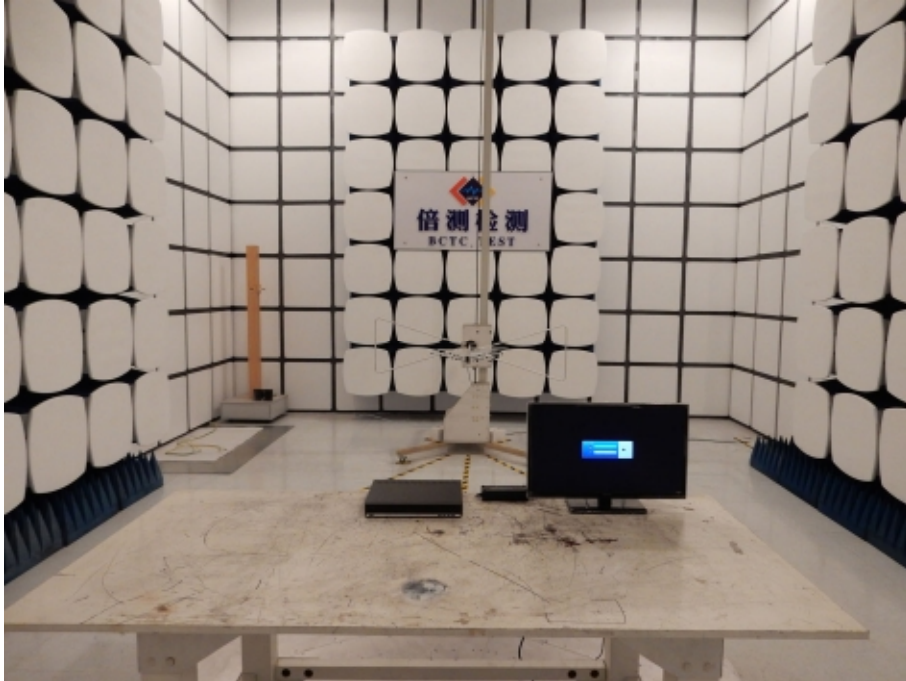

CE



ESD





Surge



\*\*\*\*\* END OF REPORT \*\*\*\*\*