

The Intelligent Surveillance Solution

NVC

User Manual (Remote)

Ver. 3.1.0

Table of Contents

1.	Installation	8
1.1	Installation Process.....	8
2.	Settings	18
2.1	Camera Setup	18
2.1.1	Add Cameras by Camera Search	18
2.1.2	Add Cameras Manually.....	20
2.1.3	Modify Camera Information	21
2.1.4	Modify Camera Parameters	21
2.1.5	Set up Lens Settings.....	22
2.1.6	View Camera Status Details.....	23
2.2	Recording & Event Setup.....	25
2.2.1	Recording Mode Setup	25
2.2.2	Recording Schedule / Event Setup.....	25
2.2.3	Advanced	30
2.2.4	Camera Events and Responding Actions Setup.....	31
2.2.5	I/O Box Input and Responding Action Setup	33
2.2.6	System Events and Responding Actions Setup	34
2.2.7	Push Notification.....	36
2.2.8	SMTP Server Setup.....	38
2.2.9	Add Event Contacts	39
2.2.10	Set up FTP Server	40
2.3	RAID & File Settings.....	41
2.3.1	Create a RAID Volume	41
2.3.2	View RAID Volume Status.....	43
2.3.3	View Disk Drive Information.....	44
2.3.4	Modify RAID Volume	46
2.3.5	Delete a RAID Volume.....	49
2.3.6	Format	50
2.3.7	Modify the FTP Protocol Settings	51
2.4	Auto Backup	51
2.4.1	Set up Backup Schedule.....	52
2.5	Network Setup.....	53
2.5.1	View Network Status.....	53
2.5.2	Network Settings.....	53
2.5.3	Auto Port-Forwarding.....	56
2.5.4	Network Service Setup.....	58

2.5.5	CMS Service Setup	59
2.5.6	findNVR	59
2.6	Management.....	61
2.6.1	View the List of Users.....	61
2.6.2	Create New Users.....	61
2.6.3	Modify User Information.....	62
2.6.4	Change a User’s Password.....	62
2.6.5	Delete Users	63
2.6.6	Online License Activation	63
2.6.7	Offline License Activation	64
2.6.8	Online License Transfer.....	66
2.6.9	Offline License Transfer.....	67
2.6.10	View the Event Log	68
2.6.11	Save Unit Configuration	69
2.6.12	Load Unit Configuration / Default Settings	70
2.7	System.....	71
2.7.1	View System Information.....	71
2.7.2	Smart Fan Control.....	72
2.7.3	Buzzer Configuration.....	72
2.7.4	UPS Setup	73
2.7.5	Upgrade the System	73
2.7.6	System Date and Time Setup	74
2.7.7	Restart the Unit.....	75
2.7.8	Shut Down the Unit.....	76
3.	POS	78
3.1	Introduction	78
3.1.1	System Introduction	78
3.1.2	Hardware Installation – SCB-C31A	79
3.1.3	Software Installation – SCB-C31A.....	80
3.1.4	Connection via TCP Client.....	81
3.2	Software Setup.....	82
3.2.1	Activate POS License	82
3.2.2	NVR POS Setting.....	82
3.2.3	Insert POS Setting	83
3.2.4	Delete POS Device	85
3.2.5	Configure POS Setting.....	85
3.3	Tag Filter	85
3.3.1	Add New Tag Filter.....	85

3.3.2	Edit Tag Filter	88
3.3.3	Delete Tag Filter	88
3.3.4	Import/Export Tag Filter	89
3.4	POS Display Font	89
3.4.1	Live View	89
3.4.2	Remote Live Viewer	90
3.4.3	Playback	91
3.4.4	Playback System	92
3.5	POS Transaction Data Search	93
3.5.1	Search POS Transaction Data through Playback	93
3.5.2	Search POS Transaction Data through Playback System	95
3.6	Playback Video with POS Data	95
3.6.1	Select Period by POS Search	95
3.6.2	Select Period by Data & Time through Playback	96
3.6.3	Select Period by Data & Time through Playback System	96
3.7	Backup Video with POS Data	96
3.7.1	Backup through Internet Explorer	96
3.7.2	Backup through Playback System	97
3.7.3	Backup through Backup System	97
4.	I/O	99
4.1	Introduction	99
4.1.1	System Introduction	99
4.1.2	HW Installation	99
4.1.3	Software Installation – SCB-C31	100
4.1.4	Software Installation – SCB-C24/26/28	101
4.2	Software Setup	103
4.2.1	Add I/O Box	103
4.2.2	Modify I/O Box Information	104
4.2.3	I/O Pin Setting	104
4.3	Relative Configuration and Application	105
4.3.1	Record on Input Trigger	105
4.3.2	Input and Responding Actions	105
4.3.3	I/O Control Panel in Live View	105
5.	Live view	106
5.1	Internet Explorer	106
5.1.1	Live View Control Panel	106

5.1.2	Live View Setting.....	109
5.1.3	General Setting	109
5.1.4	Stream Profile Setting	110
5.1.5	OSD (On-screen display) Setting.....	111
5.1.6	Monitor Display Setting.....	111
5.1.7	Notification	112
5.1.8	Set up Joystick Control	113
5.2	Remote Live Viewer Application	115
5.2.1	Remote Live Viewer Application Control Panel	115
5.2.2	Unit Connection Setting.....	118
5.2.3	General Setting	119
5.2.4	Camera Group Setting.....	121
5.2.5	Delete/ Rename Camera Groups	121
5.2.6	Stream Profile Setting	122
5.2.7	OSD (On-screen display) Setting.....	122
5.2.8	Monitor Display Setting.....	123
5.2.9	Notification	124
5.2.10	Set up Joystick Control.....	125
5.2.11	Set up Remote Live Viewer.....	126
6.	E-Map.....	127
6.1	Internet Explorer	127
6.1.1	E-Map Control Panel.....	127
6.1.2	Add Map	128
6.1.3	Edit Map	129
6.1.4	Delete Map.....	129
6.1.5	Add/Rotate Device Indicator.....	129
6.1.6	Delete Device Indicator	129
6.1.7	Layout Adjustment	130
6.1.8	Relative Configuration and Application	130
6.2	Remote Live Viewer Application	131
6.2.1	E-Map Control Panel.....	131
7.	Playback.....	132
7.1	Internet Explorer	132
7.1.1	Playback Control Panel.....	132
7.1.2	Search the Recorded Video	134
7.1.3	Play the Recorded Video.....	136
7.1.4	Intelligent Search.....	136
7.1.5	Recorded Video Enhancement.....	137

7.1.6	Save a Video	138
7.1.7	Save an Image	139
7.1.8	Print an Image.....	140
7.1.9	Backup the Recorded Video	141
7.2	Remote Playback System Application	143
7.2.1	Playback System Application Control Panel	143
7.2.2	Set up Unit Connections.....	143
7.2.3	Search the Recorded Video	144
7.2.4	Play the Recorded Video.....	145
7.2.5	Intelligent Search.....	145
7.2.6	Recorded Video Enhancement.....	146
7.2.7	Save a Video	147
7.2.8	Save an Image	148
7.2.9	Print an Image.....	148
7.2.10	Backup the Recorded Video.....	149
8.	Backup and Delete Records	150
8.1	The Backup System Application	150
8.2	Backup the Recorded Video through FTP.....	152
8.3	Playback the Backup Records.....	153
8.3.1	With Playback Application.....	153
8.3.2	Without Playback Application	153
8.4	Delete the Recorded Video	153
8.4.1	With Backup Application.....	153
8.4.2	Without Backup Application	155
9.	Verification Tool.....	157
9.1	Execute Verification Tool.....	157
9.2	Verify Image / Video	158
10.	External Storage.....	159
10.1	Create a Volume on DAS	159
10.2	Create an External Storage	159
11.	Log out	161
12.	Remote PC System Requirements	162
12.1	UPnP Support	162
13.	Troubleshooting.....	162
13.1	Replace a Failed Disk Drive.....	162
13.2	Respond to a Critical RAID Volume	162
13.3	Respond to a File System Error RAID Volume	163
13.4	Restore the Default Administrator's Password.....	163

13.5	Restore All Default Configuration	163
13.6	Install ActiveX	163
13.7	Cannot Log in to the Unit with Internet Explorer	164
Appendix – RAID System		165
Introduction to RAID		165
RAID 0 – Stripe		165
RAID 1 – Mirror		166
RAID 5 – Block Striping with Distributed Parity		167
RAID 10 – Mirror / Stripe		167
Choosing a RAID Level		168

GNU General Public License

This product includes copyrighted third-party software licensed under the terms of the GNU General Public License. Please see the GNU General Public License (GPL) for the exact terms and conditions of this license at **www.gnu.org**.

Subject to GPL, you may re-use, re-distribute and modify the GPL source code.

Note that with respect solely to the GPL Software, no warranty is provided. We do not offer direct support for the distribution.

1. Installation

1.1 Installation Process

Step 1: Unpack the Unit

This package contains the following items:

The unit	✓
Mouse	✓
Disk screws	✓
Power	12V 5A 60W power adapter, power cord
Warranty card, Quick Start Guide, CD	✓
Networking cable	✓

*CD content: **Install Wizard, Remote Live Viewer, Playback System, Backup System, Verification Tool and Offline License Tool** application, user manual, and quick start guide



To configure the unit, you must install the software onto a desktop/ laptop running Windows XP-SP3 32bit, Windows 7 32/64bit, Windows 8 32/64bit.

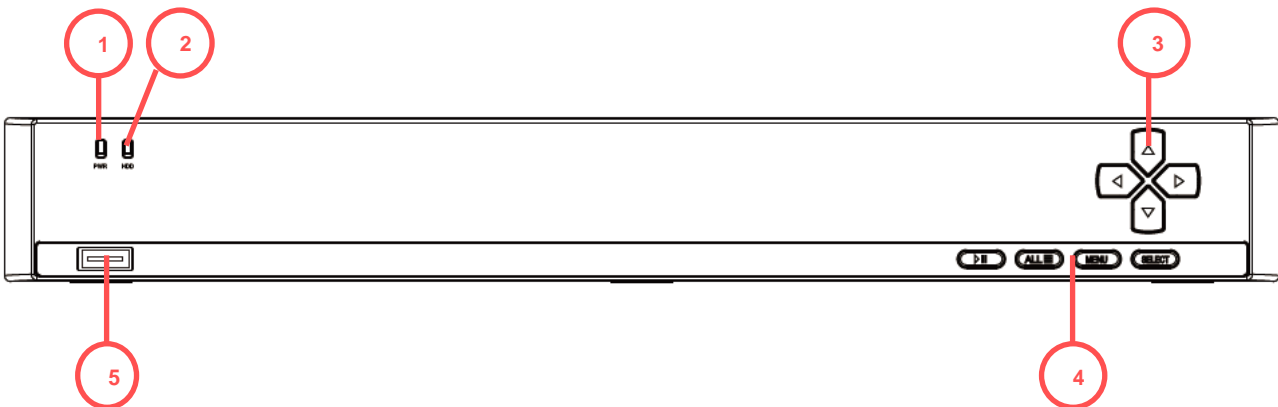

Front View









Status LED:

No.	Description	Status Notice	Remark
1	Power Status LED	<ul style="list-style-type: none"> ▶ Power-on: red ▶ Power-off: dark 	--
2	System/ HDD Status LED	<ul style="list-style-type: none"> ▶ System healthy: dark ▶ System unhealthy: green with quick blinking ▶ HDD healthy: dark ▶ HDD unhealthy: green with quick blinking ▶ HDD rebuild: green with slow blinking ▶ No HDD: green 	1) Quick blinking (0.5 seconds On/ 0.5 seconds Off) 2) Slow blinking (1 second On/ 1 second Off)

External Control and I/O Ports:

No.	Description	
3	◀ ▶ Left/Right arrow keys	These keys can be hit to move left and right between the menus of the Main Menu and the highlighted items on all setting pages.
	▲ ▼ Up/Down arrow keys	These keys can be hit to move up and down between the submenus of a menu and the highlighted items on all setting pages.
4	 Menu	Opens the system's Main Menu . ▶ See Settings to know all the settings featured by the Main Menu . ▶ This key is only applicable to Live View screen.
	 Live View/ Playback	Switches the screen to Live View or Playback .
	Select key	This key delivers the same function as clicking the OK or Save button on a tab or dialog . Its functions include: ▶ Quitting a tab saving the change(s). ▶ Applying the change(s) made on a tab.
	Cancel key	This key delivers the same function as clicking the Exit or Cancel button on a tab or dialog . Its functions include: ▶ Quitting a tab without saving the change(s). ▶ Closing a dialog or a tab.
5	USB 2.0 connector	

 Press  and  button simultaneously for 5 seconds to reset system to default.

 Press  and  button simultaneously for 5 seconds to reset password to default.

Rear View

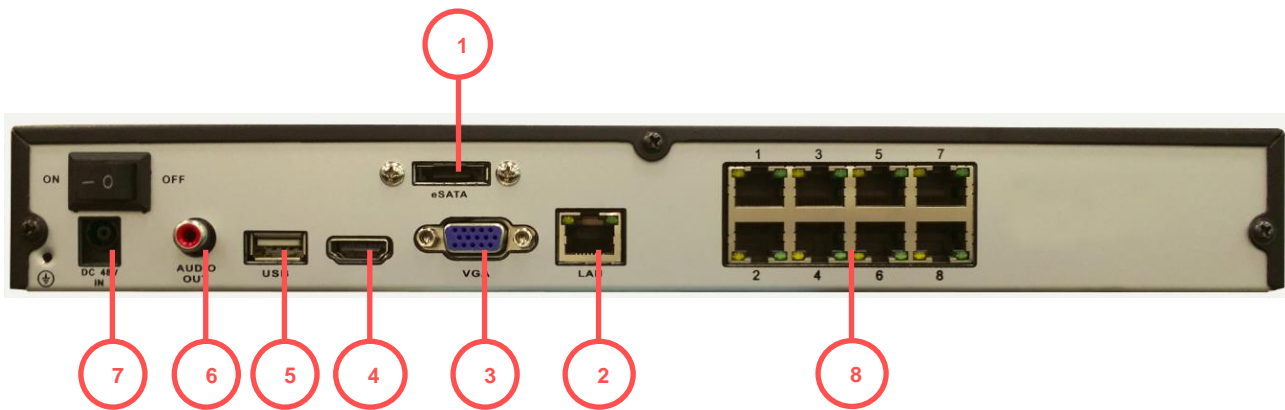

Status LED:

No.	Description	Status Notice	Remark
-----	-------------	---------------	--------

3	Ethernet Activity LED	<ul style="list-style-type: none"> ▶ Linking: green ▶ Accessing: green with blinking ▶ No linking: dark 	<ul style="list-style-type: none"> 1) LED for Ethernet port 2) Blinking (200 ms On/ 200 ms Off)
---	-----------------------	--	---

External Control and I/O Ports:

No.	Description
1	eSATA connector
2	RJ-45 LAN port
3	VGA connector
4	HDMI connector
5	USB 2.0 connector
6	RCA audio out
7	DC-in power connector
8	POE switch

Step 2: Install Hard Drives

Refer to compatibility list and install HDDs. For optimal performance consideration, install disks with the same model and storage capacity. The available RAID level depends on the amount of disks installed.

1. Open the lid of the unit.
2. Carefully lock the disks into the HDD tray with screws. 4 screws for each disk. Lock the lid of the unit once you finished.

	<ul style="list-style-type: none"> ● When installing HDDs on HDD bracket, please beware of sharp edges.
---	--

Step 3: Connect the Unit and Devices within the Network

1. Connect the unit, cameras, and router/switch.
2. If you need to make the video visible over the Internet, please connect to a "router" with Internet connection, and the unit will retrieve an IP address through DHCP by default.

	The unit processes built-in DHCP service, which takes the job of router to assign IP addresses, which is suitable for the pure LAN environment.
---	---

Step 4: Connect the Monitor (Local)

1. The unit processes two display interfaces, VGA and HDMI. Connect the

monitor to the unit.



The supporting display resolutions are 1920x1080, 1280x1024, 1280x720, and 1024x768. Please confirm that one of the resolutions is supported by your monitor.

Step 5: Connect the Power

1. Attach the power cord from the power source to the power adapter.
2. Connect the power adapter to the back of the unit enclosure. See the rear view figure.

Step 6: Install the Software

Please be noticed that you can choose to start up system on the local side or from the remote side. Here is the introduction of remote startup. If you are interested in the local part, please refer to "User Manual (Local)".

1. Insert the CD into your CDROM.
2. Double-click **Setup.exe** to begin installation.
3. Follow the instruction of **Setup.exe**, and click the **Finish** button to close the installer.

Step 7: Set up the Unit

The software **Installation Wizard** performs the setup procedures on the unit. After the procedure, you can begin using it.

1. Go to Start > NVR > NVR Install Wizard.
2. This program will show the default language setting and initiation mode.
3. Choose your preferred language and initiation mode, and then click the  button.

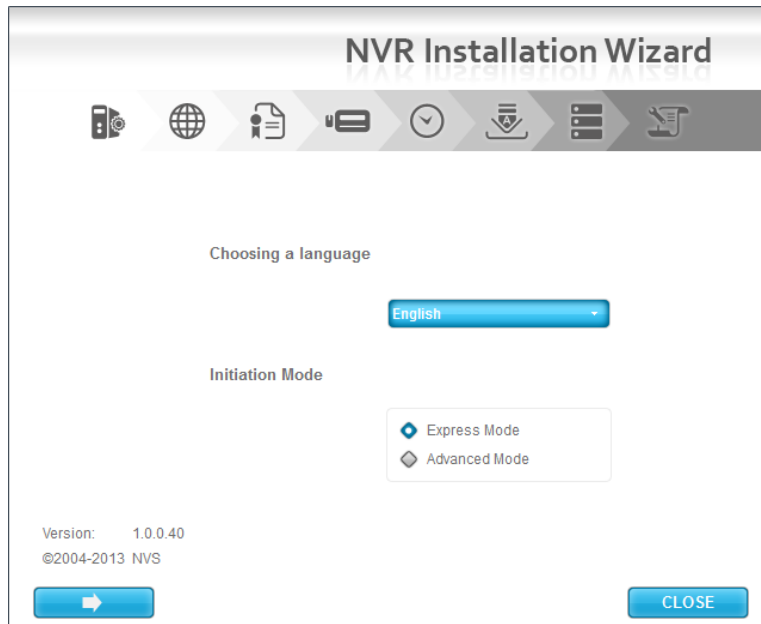

- **Express Mode:** you don't need to set up the network settings and RAID level.
- **Advanced Mode:** configure all settings manually: network, license, camera, Date/Time, and RAID level

4. The **Installation Wizard** program starts searching for all the units on the internet currently. Choose one of them, and then click the  button.

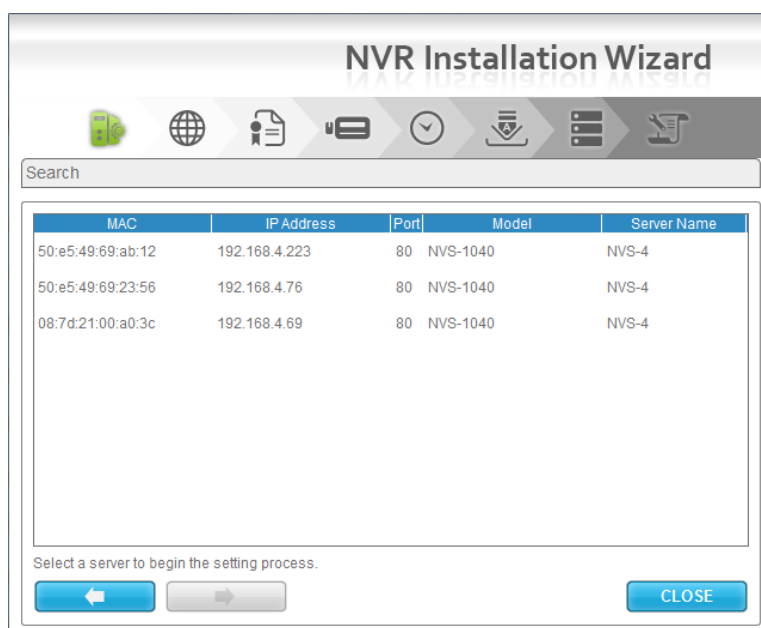

5. Type in the password, and then click the **OK** button.

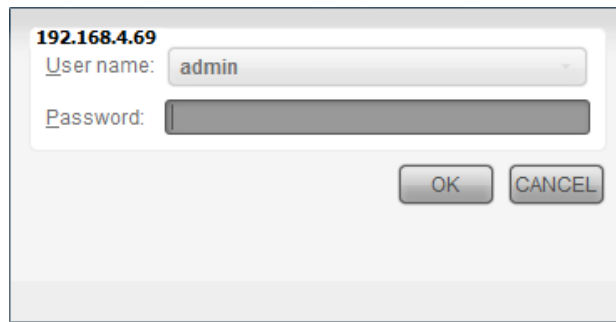



192.168.4.69

User name:

Password:

OK CANCEL

 The default Administrator password is "admin".

6. Name this server and select the network type, and then click the  button.

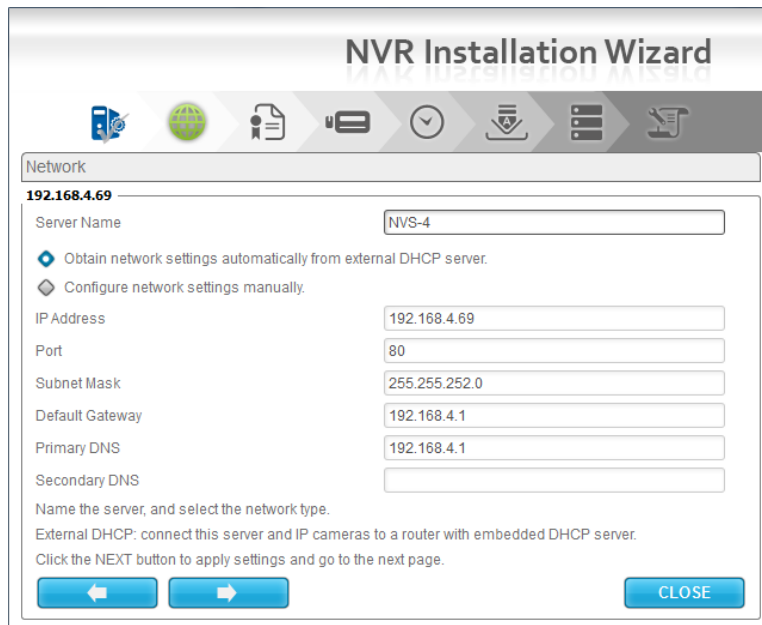

NVR Installation Wizard

Network

192.168.4.69

Server Name:

Obtain network settings automatically from external DHCP server.
 Configure network settings manually.

IP Address:

Port:

Subnet Mask:

Default Gateway:

Primary DNS:

Secondary DNS:

Name the server, and select the network type.
 External DHCP: connect this server and IP cameras to a router with embedded DHCP server.
 Click the NEXT button to apply settings and go to the next page.

← → CLOSE

- **Obtain network settings automatically from external DHCP server:** apply all settings which are automatically generated by the DHCP server, such as IP, subnet mask, gateway, and DNS.
- **Configure network settings manually:** configure the preferred settings one by one.

7. Activate camera license to have more channel capacity, and click the  button.

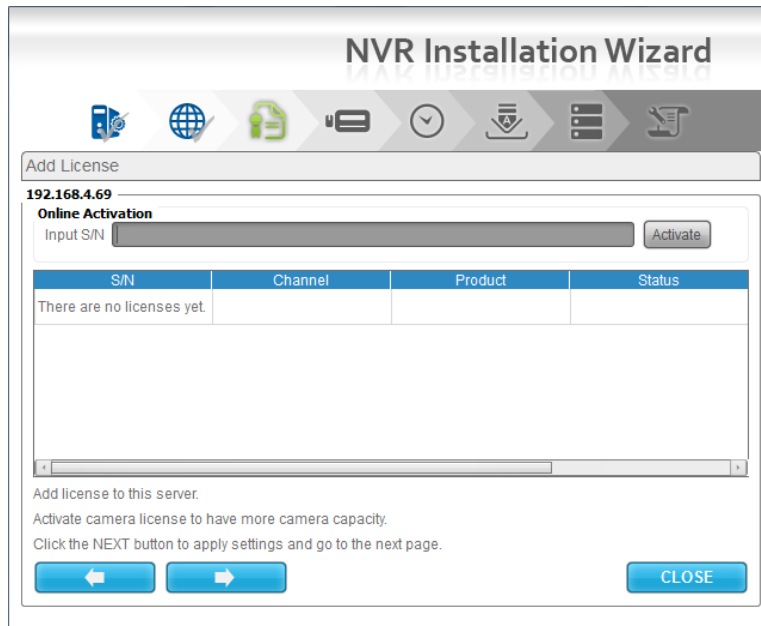

8. Add cameras for this server. There are two ways of adding cameras, selecting the searched cameras and manually configuring the cameras. Click the button after completing camera list.

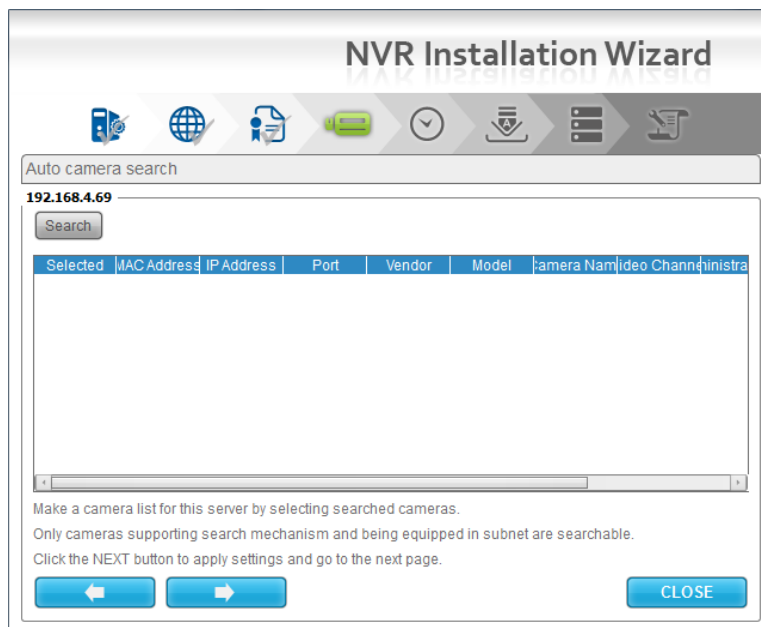

NVR Installation Wizard

Auto camera search

192.168.4.69

Search Current channel capacity: 3 (Max: 4) 60%

Selected	MAC Address	IP Address	Port	Vendor	Model	Camera Name	Video Channel	Adn
1 <input type="checkbox"/>	54-42-49-D5-EA-8B	192.168.4.88	80	Sony	SNC-CH220		1	

Make a camera list for this server by selecting searched cameras.
 Only cameras supporting search mechanism and being equipped in subnet are searchable.
 Click the NEXT button to apply settings and go to the next page.

←
→
CLOSE

NVR Installation Wizard

Manual camera setting

192.168.4.69

Camera Name	IP Address	Port	Administrator Name	Password	Vendor
1 Camera 1	192.168.4.88	80	admin	admin	Sony
2		80			-- none --
3		80			-- none --
4		80			-- none --

Make a camera list for this server by adding cameras manually.
 Click the Auto Detection button to obtain vendor/model automatically after filling in other fields.
 Click the NEXT button to apply settings and go to the next page.

←
→
CLOSE

9. Set up the time zone, date, and time, and adjust daylight saving changes if needed. Once daylight saving function is enabled, the time change will activate automatically every year based on the recurrence you set. Click the button.

NVR Installation Wizard

Date/Time

192.168.4.69

Time Zone: (GMT+08:00) Beijing, Hong Kong, Kuala Lumpur, Perth, Singapore, Taipei, Urumqi

Date: 3/26/2013

Time: 6:29:10 PM

Adjust clock for daylight saving changes +2 hour(s) every year

Start Time: 2:00

 Date: 03-11 (MM-DD)

 Month: 1 First Sunday

End Time: 2:00

 Date: 11-04 (MM-DD)

 Month: 1 First Sunday

10. Follow the following instruction and select the RAID type you want to create. Click the button.

NVR Installation Wizard

RAID

192.168.4.69

None
 RAID 0
 RAID 1
 RAID 5
 RAID 10

Current RAID List:

Volume	RAID Level	Disks
1 VOLUME1	RAID0	1863 GB ST2000NM0011

Select a RAID type for the recording data.

RAID 0: Maximize the storage space (Minimum number of disks: 1).

RAID 1: Protect the data by a series of mirrored drives (Minimum number of disks: 2).

The available RAID level depends on the amount of disks installed.

11. Review your settings. If the settings are correct, click the **Finish** button to exit the settings procedure and activate the system.

NVR Installation Wizard



Setting List

192.168.4.69

Item	Settings
Server Name	NVS-4
Time Zone	GMT+8
Date/Time	2013/03/26 18:19:39
IP Address	192.168.4.69
Port	80
RAID Type	There is no volume created.
Recording Schedule	No

Click the "FINISH" button to activate the configuration, which takes time. Please wait...

← FINISH CLOSE



Once the "FINISH" button is clicked, the unit will start working. In order to ensure the stability of the unit, never pull any disks out when the system is running.

2.Settings

After setting up the unit, log in to the system by entering its IP address in the browser(Internet Explorer 8, 9, 10, Mac Safari 7.0, Windows Chrome). When connecting, choose your language, enter the username and password, and then begin using this system.

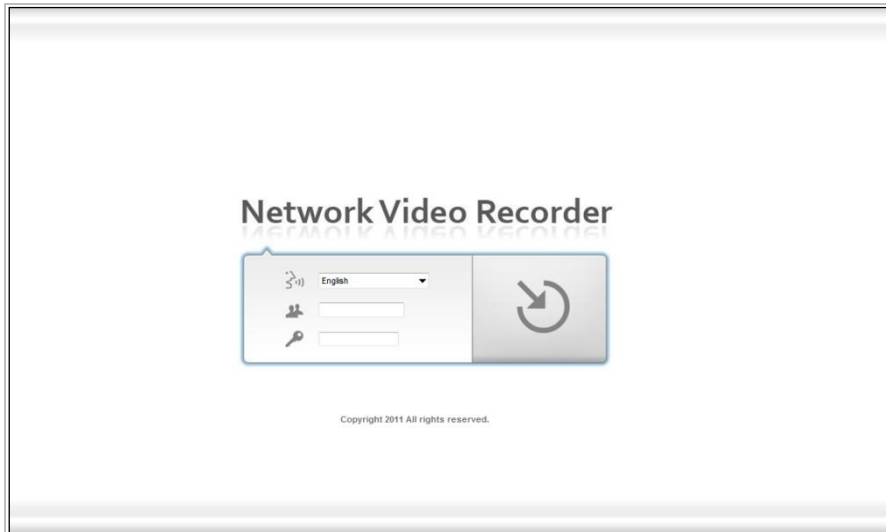

There are four main functions of this unit: settings, live view, playback, and logout. They will be shown on the top of the page. Current firmware version and free storage capacity are shown above the function list.



2.1 Camera Setup

2.1.1 Add Cameras by Camera Search

The function enables user to automatically search and add cameras in the same network. There are two search mechanisms, one is UPnP, another is camera search tool. Before searching UPnP cameras, make sure that the cameras possess UPnP function.

1. Open Internet Explorer, Mac Safari or Windows Chrome and log in to the unit.

2. Click **IP Camera/ Camera Settings**.
3. Click the **Camera Search** tab.
4. Click the **Search** button.

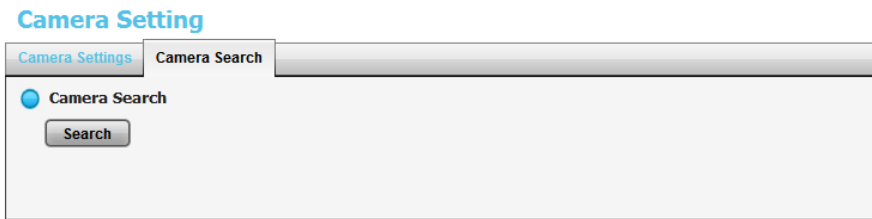

5. The system will list all the currently available cameras. The inserted cameras are shown in blue. Click the **+** icon to add a camera into your camera list.

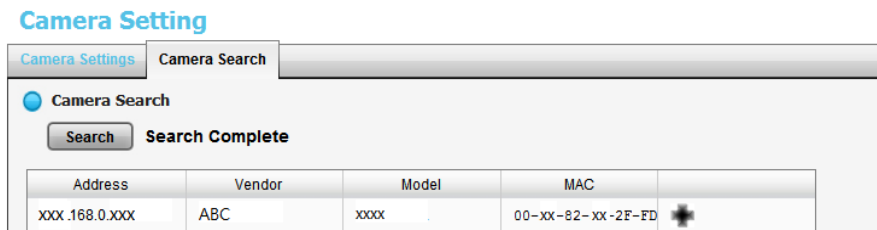

6. After clicking the **+** icon, the camera setting page will pop up. Click the item to which you want to add a camera.
7. Insert the camera name, username, and password.

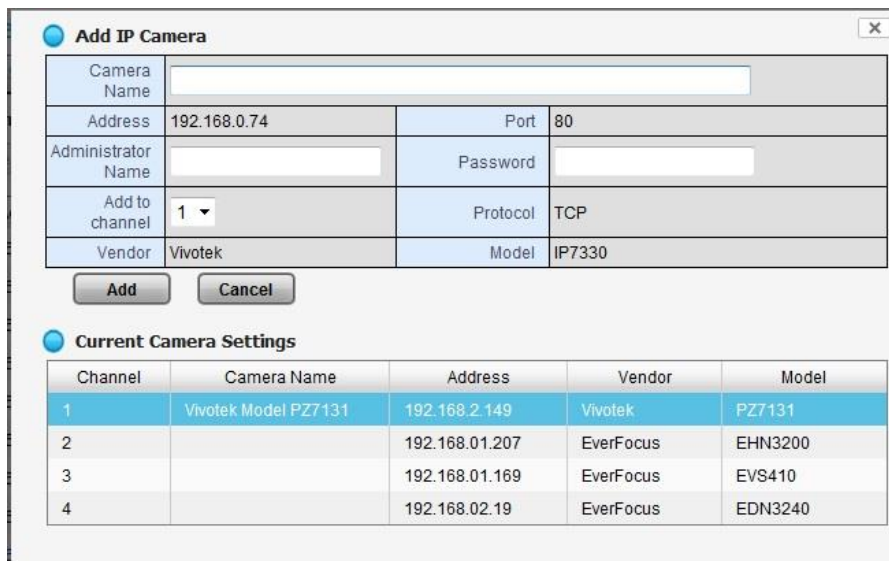

To have better compatibility between camera and system, please make sure the privilege of camera credential is admin-level.

- Click the **Add** button to add it.
- After clicking the **Add** button, the updated camera list will be displayed in the **Camera Setting** tab.

No.	Camera Name	Address	Port	Vendor	Model
1	Camera 1	192.168.0.96	80	PPP	123
2	Camera 2	192.168.1.233	4088	AAA	214
3			80	-- none --	-- none --
4			80	-- none --	-- none --

2.1.2 Add Cameras Manually

- Open Internet Explorer, Mac Safari or Windows Chrome and log in to the unit.
- Click **IP Camera / Camera Settings**.
- Click the **Camera Settings** tab, and the camera list will be displayed on the bottom of the page.
- Click on the camera list for the channel you want to add and enter the camera's information.

No.	Camera Name	Address	Port	Vendor	Model
1	Camera 1	192.168.0.96	80	PPP	123
2	Camera 2	192.168.1.233	4088	AAA	214
3			80	-- none --	-- none --
4			80	-- none --	-- none --

Camera Settings

Camera Settings		Camera Search	
Camera Settings			
Camera No.	Camera 3		
Camera Name	<input type="text"/>		
Address	<input type="text"/>	Port	80
Administrator Name	<input type="text"/>	Password	<input type="text"/>
Video Channel	<input type="text"/>	Protocol	<input type="radio"/> TCP <input type="radio"/> UDP <input checked="" type="radio"/> HTTP
Vendor	-- none --	Model	-- none --
<input type="button" value="Save"/>		<input type="button" value="Reset"/>	
<input type="button" value="Clear"/>		<input type="button" value="Auto Detection"/>	

- **Camera name:** The name of the camera.
- **Address:** The IP address.
- **Port:** The transmission port.

- **Administrator Name**: Login username.
- **Password**: Login password.
- **Video Channel**: Select the number of analog cameras supported by one video server or select the number of IP cameras possessing multiple lens/channels.
- **Protocol**: Data transmission protocol.
- **Vendor**: Camera vendor name.
- **Model**: Camera model name.



To have better compatibility between camera and system, please make sure the privilege of camera credential is admin-level.

5. Click the **Save** button.

- **Save**: Save the information of this camera.
- **Reset**: Return to the latest saved settings of the selected camera.
- **Clear**: Set all the settings to default value.
- **Auto Detection**: After inserting IP address, port, username, and password, click this button to automatically detect other camera information, including Channel, Protocol, Vendor, and Model.

2.1.3 Modify Camera Information

1. Open Internet Explorer, Mac Safari or Windows Chrome and log in to the unit.
2. Click **IP Camera / Camera Settings**.
3. Click the **Camera Settings** tab.
4. Click the camera which you want to modify.
5. Modify the information of this camera.
6. Click the **Save** button.
7. Use the same method to replace a camera if needed.

2.1.4 Modify Camera Parameters

Stream profile is designed for mobile client and lower fps live stream display. Without stream profile integration, users cannot watch live video on mobile client nor select lower fps stream on live view. Further, for performance consideration, we fix the resolution and frame rate for each brand/series. Refer to **camera support list**.

1. Open Internet Explorer and log in to the unit.

2. Click **IP Camera / Camera Parameters**.
3. Click the **Camera Parameter** tab.
4. Click the camera which you want to modify on the camera list.
5. Modify the information of this camera.
6. Click the **Save** button.

Camera Parameters

Camera Parameters Lens Settings

Camera Parameters

Camera No. **Camera 1**

Camera Name **Camera 1**

Multi-Stream Settings Enable (Customize) Enable (Auto) Disable

Stream	Stream 1 (Main)	Stream 2	Stream 3
Video Format	H.264	H.264	H.264
Frame Rate	1	5	5
Resolution	half	half	half
Quality / Bit Rate	65535	512	96

Audio Enable

- **Camera Name**: The name of the camera.
- **Multi-stream Settings**: Enable/Disable camera multi-stream.
- **Stream**: Support up to three streams.
- **Video Format**: Choose the type of format which this camera supports.
- **Frame rate**: Select the frame rate of the camera.
- **Resolution**: Select the resolution of the camera.
- **Quality/Bit Rate**: Select the image quality of the camera.
- **Audio**: Check the **Enable Audio** option to view and enable audio recording.



In NVR Version 3.0, Video Format can support up to H.265 with supported for Record, Live view and Playback with **supported camera only**.



H.265 Live view/ Playback only available on remote client.

2.1.5 Set up Lens Settings

1. Open Internet Explorer, Mac Safari or Windows Chrome and log in to the unit.
2. Click **IP Camera / Camera Parameters**.
3. Click the **Lens Settings** tab.
4. Click the camera which you want to modify in the camera list.
5. Modify the information of this camera.
6. Click the **Save** button.

Camera Parameters

Camera Parameters | Lens Settings

Lens Settings

Camera Name: Camera 1

Lens: Enable

Lens Type: ImmerVision IMV1-1/3

Camera Position: -- none --

Save

- **Camera Name:** The name of the camera.
- **Lens Type:** There are two types of lens currently, ImmerVision and Vivotek (FE8171V). You are not allowed to select type so far, type depends on camera model.
- **Lens:** Enable or disable lens function.
- **Camera Position:** Select the position of the camera.

 If users enable the lens while lens is not installed correctly or not even installed, a warning message will pop up as a notification if users are trying to operate lens on liveview page.

























2.1.6 View Camera Status Details

1. Open Internet Explorer, Mac Safari or Windows Chrome and log in to the unit.
2. Click IP Camera / Details

Camera Status

Camera Status | Details

Camera Status

No.	Name	Address	Connection Status	Rec. Status	Frame Rate	Bit Rate
1	Camera 1	10.0.8.126	 	 	0.0 fps	0.0 Kbps
2	Champ	10.0.16.16	 	 	25.0 fps	2328.3 Kbps
3		10.0.8.126	 	 	0.0 fps	0.0 Kbps
4		10.0.8.126	 	 	0.0 fps	0.0 Kbps
5		10.0.8.126	 	 	0.0 fps	0.0 Kbps
6		10.0.8.126	 	 	0.0 fps	0.0 Kbps

- **Stream 1:** The bit rate of stream 2
- **Stream 2:** The bit rate of stream 3
- **Stream 3:** The bit rate of stream 3
- **Total Bit Rate:** The total bit rate of the camera

 If your total bit rate becomes red, it means that the loading of the system is too heavy.

- **Conn. Status:** The status of the connection. Click the **Connect** or **Disconnect** button to change the connection status.

	Status	Icon
Connection Status	Connected	
Connection Status	Disconnected	
Connection Status	Connecting	
Connection Button	Connected: Normal	
	Connected: Over	
Connection Button	Disconnected: Normal	
	Disconnected: Over	

- **Rec. Status:** The set recording schedule of this camera in this time.

	Status	Icon
Recording Status	No Recording	
Recording Status	Always Recording – Recording with 1 st stream	
Recording Status	Always Recording – Recording with 2 nd stream	
Recording Status	Always Recording – Dual recording with both stream	
Recording Status	Always Recording – Stopped	
Recording Status	Schedule Recording – Recording	
Recording Status	Schedule Recording – Stopped	

- **Frame Rate:** The frame rate of this camera.
- **Bit Rate:** The transmission bit rate of this camera.
- **Estimated Remaining Recording Time:** Estimated remaining recording time is dividing the current free capacity by dynamic total bit rate.



If your total bit rate becomes red, it means that the loading of the system is too heavy.

2.2 Recording & Event Setup

2.2.1 Recording Mode Setup

1. Open Internet Explorer, Mac Safari or Windows Chrome and log in to the unit.
2. Click **Recording & Event / Recording settings**.
3. Click the **Recording Mode** tab.
4. If selecting **Always Record**, the chosen cameras will begin to record immediately.

Recording Settings

Recording Mode | Recording Schedule | Motion | Input | Advanced

Recording Mode

No Recording

Record by Schedule

Always Record

All

Camera 1 Camera 2 Camera 3 Camera 4
 Camera 5 Camera 6 Camera 7 Camera 8
 Camera 9 Camera 10 Camera 11 Camera 12
 Camera 13 Camera 14 Camera 15 Camera 16

Automatic Recycle Recycle when the storage space is less than 10 %

Keep Video Keep Video 7 Days

Save Reset

- **No Recording**: Turn off the recording.
- **Recording by Schedule**: Recording by schedule.
- **Always Record**: Permanently turn on the chosen cameras.
- **Automatic Recycle**: Check the **Enable** option and select the timing of automatic recycle works. We strongly suggest recycling the disk(s) when the storage space is less than 10%. (default: 10%)
- **Keep Video**: Set a period during which the recorded video clips will be kept intact. (max: 365)



The privilege of automatically recycle is higher than keep video if you select both.

2.2.2 Recording Schedule / Event Setup

Instead of **Always Record**, you can begin the recording by setting the

Recording Schedule.

1. Open Internet Explorer, Mac Safari or Windows Chrome and log in to the unit.
2. Click **Recording & Event / Recording Settings**.
3. Click the **Recording Schedule** tab.
4. Check the **Day** or **Week** mode.
 - **Day**: Schedule the recording to turn the recorder on and off at the same time every day according to your setting.
 - **Week**: Schedule the recording for each day of the week differently.
5. Click the schedule of the camera which needs to be modified.
6. Click the column at the bottom of the page.

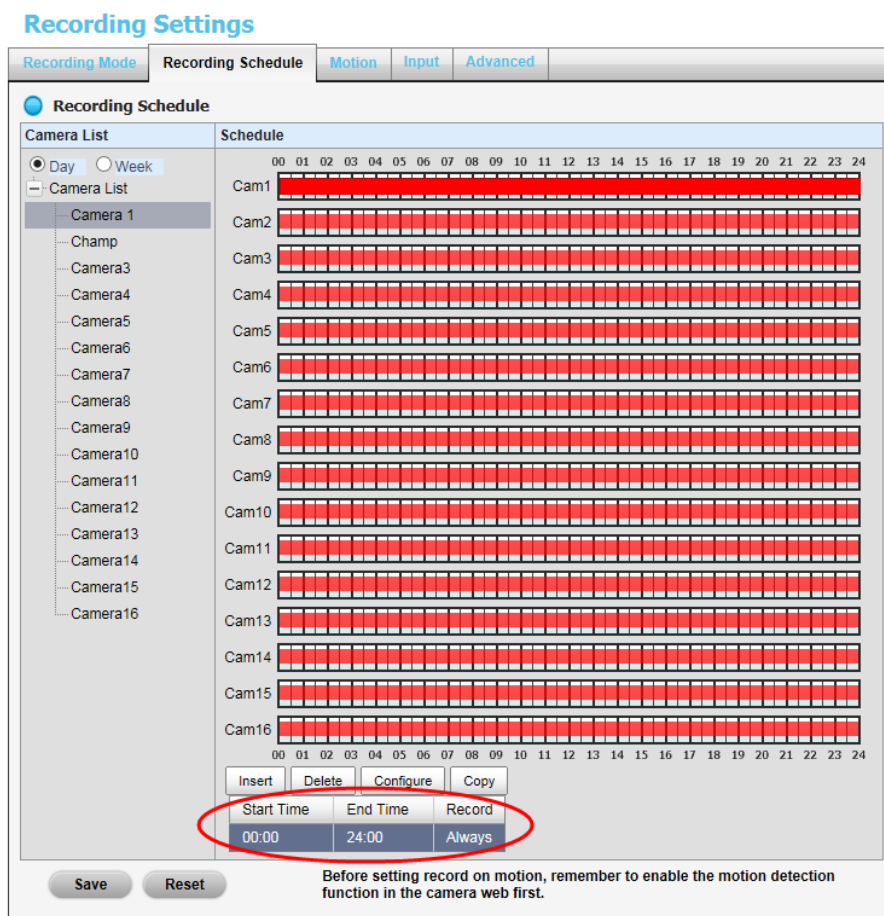

Recording Settings

Recording Mode | **Recording Schedule** | Motion | Input | Advanced

Recording Schedule

Day Week

Camera List	Schedule
Camera 1	00 01 02 03 04 05 06 07 08 09 10 11 12 13 14 15 16 17 18 19 20 21 22 23 24
Camera 2	00 01 02 03 04 05 06 07 08 09 10 11 12 13 14 15 16 17 18 19 20 21 22 23 24
Camera 3	00 01 02 03 04 05 06 07 08 09 10 11 12 13 14 15 16 17 18 19 20 21 22 23 24
Camera 4	00 01 02 03 04 05 06 07 08 09 10 11 12 13 14 15 16 17 18 19 20 21 22 23 24
Camera 5	00 01 02 03 04 05 06 07 08 09 10 11 12 13 14 15 16 17 18 19 20 21 22 23 24
Camera 6	00 01 02 03 04 05 06 07 08 09 10 11 12 13 14 15 16 17 18 19 20 21 22 23 24
Camera 7	00 01 02 03 04 05 06 07 08 09 10 11 12 13 14 15 16 17 18 19 20 21 22 23 24
Camera 8	00 01 02 03 04 05 06 07 08 09 10 11 12 13 14 15 16 17 18 19 20 21 22 23 24
Camera 9	00 01 02 03 04 05 06 07 08 09 10 11 12 13 14 15 16 17 18 19 20 21 22 23 24
Camera 10	00 01 02 03 04 05 06 07 08 09 10 11 12 13 14 15 16 17 18 19 20 21 22 23 24
Camera 11	00 01 02 03 04 05 06 07 08 09 10 11 12 13 14 15 16 17 18 19 20 21 22 23 24
Camera 12	00 01 02 03 04 05 06 07 08 09 10 11 12 13 14 15 16 17 18 19 20 21 22 23 24
Camera 13	00 01 02 03 04 05 06 07 08 09 10 11 12 13 14 15 16 17 18 19 20 21 22 23 24
Camera 14	00 01 02 03 04 05 06 07 08 09 10 11 12 13 14 15 16 17 18 19 20 21 22 23 24
Camera 15	00 01 02 03 04 05 06 07 08 09 10 11 12 13 14 15 16 17 18 19 20 21 22 23 24
Camera 16	00 01 02 03 04 05 06 07 08 09 10 11 12 13 14 15 16 17 18 19 20 21 22 23 24

Insert Delete Configure Copy

Start Time End Time Record

00:00 24:00 Always

Save Reset

Before setting record on motion, remember to enable the motion detection function in the camera web first.

- **Insert**: Insert new schedules.
- **Delete**: Delete the selected schedule.
- **Configure**: Modify the schedule and recording mode settings.
- **Copy**: Copy current **Day Schedule** to other channel(s); copy current

Week Schedule to other day(s) of a week or other channel(s).

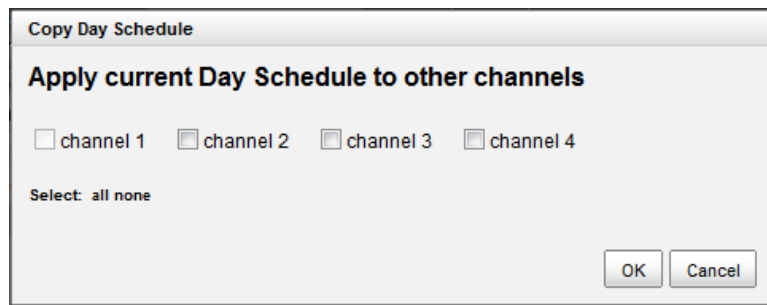

Copy Day Schedule

Apply current Day Schedule to other channels

channel 1 channel 2 channel 3 channel 4

Select: all none

OK Cancel

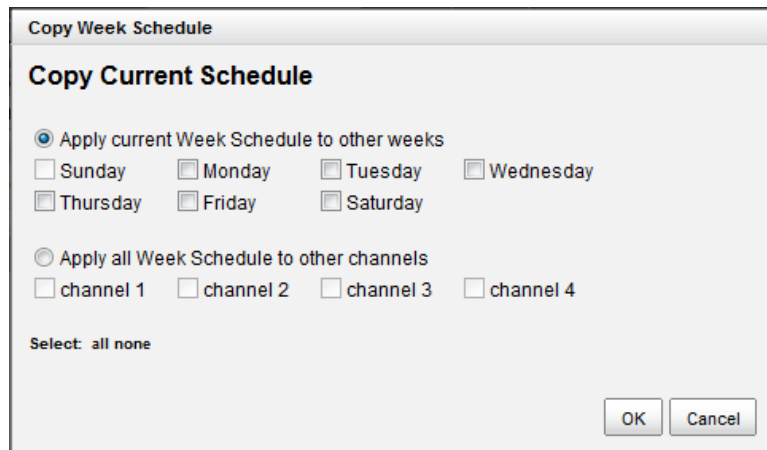

Copy Week Schedule

Copy Current Schedule

Apply current Week Schedule to other weeks

Sunday Monday Tuesday Wednesday

Thursday Friday Saturday

Apply all Week Schedule to other channels

channel 1 channel 2 channel 3 channel 4

Select: all none

OK Cancel

7. The default setting of the camera's recording schedule is from 00:00 to 24:00. If you want to modify the time slot, click the **Configure** button to modify the default settings first.

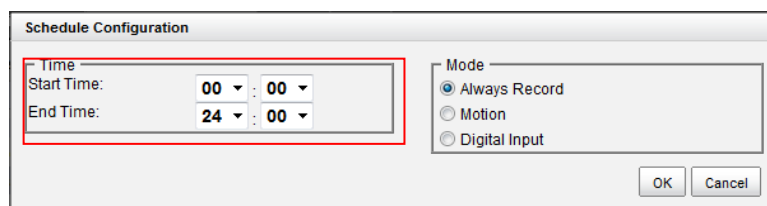

Schedule Configuration

Time

Start Time: 00 : 00

End Time: 24 : 00

Mode

Always Record

Motion

Digital Input

OK Cancel

8. Choose the recording mode.

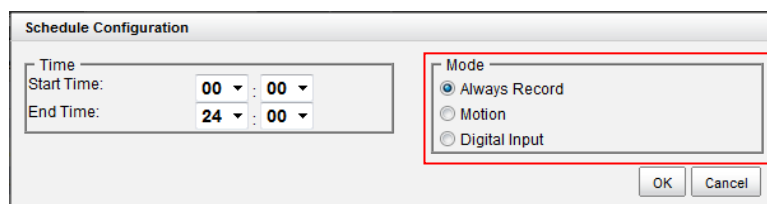

Schedule Configuration

Time

Start Time: 00 : 00

End Time: 24 : 00

Mode

Always Record

Motion

Digital Input

OK Cancel

- **Always Record**: Always record.
- **Motion**: Record when camera motion is detected. Go to the "Motion" tab

to define which camera's motion detection to associate with this channel of camera to start recording.

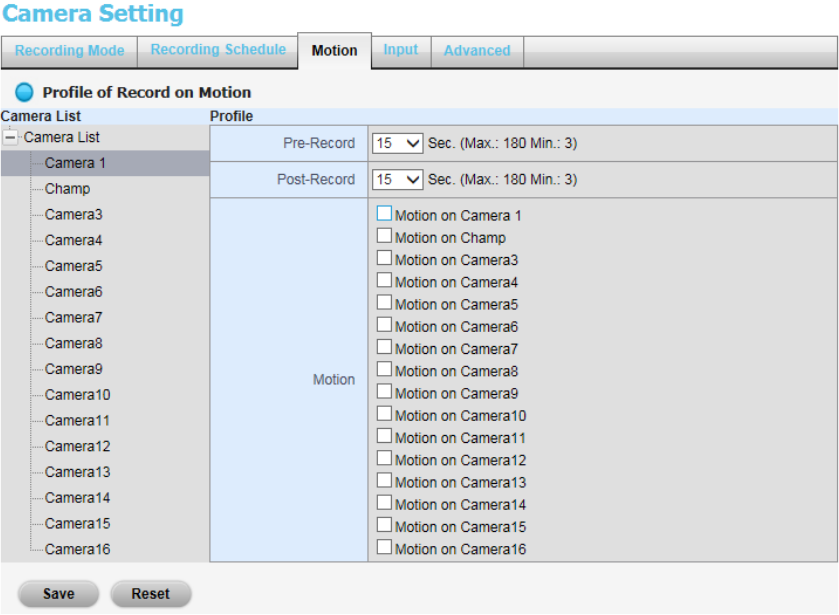

- **Digital Input:** Record when digital input is triggered. Go to the "Input" tab to define which input triggering to associate with this channel of camera to start recording.

Camera Setting

Recording Mode Recording Schedule Motion **Input** Advanced

Profile of Record on Input

Camera List Profile

Camera List: Camera 1, Champ, Camera3, Camera4, Camera5, Camera6, Camera7, Camera8, Camera9, Camera10, Camera11, Camera12, Camera13, Camera14, Camera15, Camera16

Profile: Pre-Record: 15 Sec. (Max.: 180 Min.: 3); Post-Record: 15 Sec. (Max.: 180 Min.: 3)

Expand All Digital Inputs

Digital Input: Camera 1-16 (Digital Input#1, Digital Input#2)

Save Reset



When setting the event Motion, if you prefer Motion (NVR), or embedded motion, please enable it from the local setting of the NVR.

If camera motion is preferred, please first ensure that the motion detection function of the camera has been enabled, and disable Motion(NVR) in local setting.

- If you want to add another new schedule, click the **Insert** button to add a new one.

Recording Settings

Recording Mode **Recording Schedule** Motion Input

Recording Schedule

Camera List: Camera 1, Camera 2, Camera 3, Camera 4

Schedule: 00 01 02 03 04 05 06 07 08 09 10 11 12 13 14 15 16 17 18 19 20 21 22 23 24

Cam1: [Recording Schedule Bar]

Cam2: [Recording Schedule Bar]

Cam3: [Recording Schedule Bar]

Cam4: [Recording Schedule Bar]

Buttons: Insert, Delete, Configure, Copy

Start Time	End Time	Record
00:00	14:00	Always
16:00	21:00	Always

Save Reset

Before setting record on motion, remember to enable the motion detection function in the camera web first.

- Click the **Save** button.



When changing the motion detection settings of a camera, make sure to disconnect your unit and that camera first. Once you have finished, re-connecting them will update the settings in your unit.



There is another way to set the schedule. If you want to change the recording time length, drag the end of the time bar from 24:00 back to the length you wish, and then drag the beginning of the time bar to the point at which you would like it to commence recording. (You may also click the **Insert** button to add new schedules.)

2.2.3 Advanced

1. Open Internet Explorer, Windows Chrome or Mac Safari and log in to the unit.
2. Click **Recording & Event / Recording Settings**.
3. Click **Advanced**
4. Click **Always Record**, and choose the camera in 2nd stream record section.

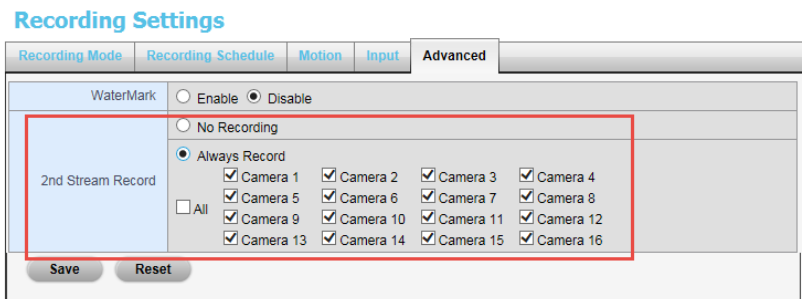

- **2nd Stream Record**: This function enables user to use 2nd for recording, thus dual record is available in version 3.0.
- **Watermark**: watermark technique is for false prevention when it is enabled. The .dat files which are generated with record video can be used for verification by Verification Tool. (default: Disable)

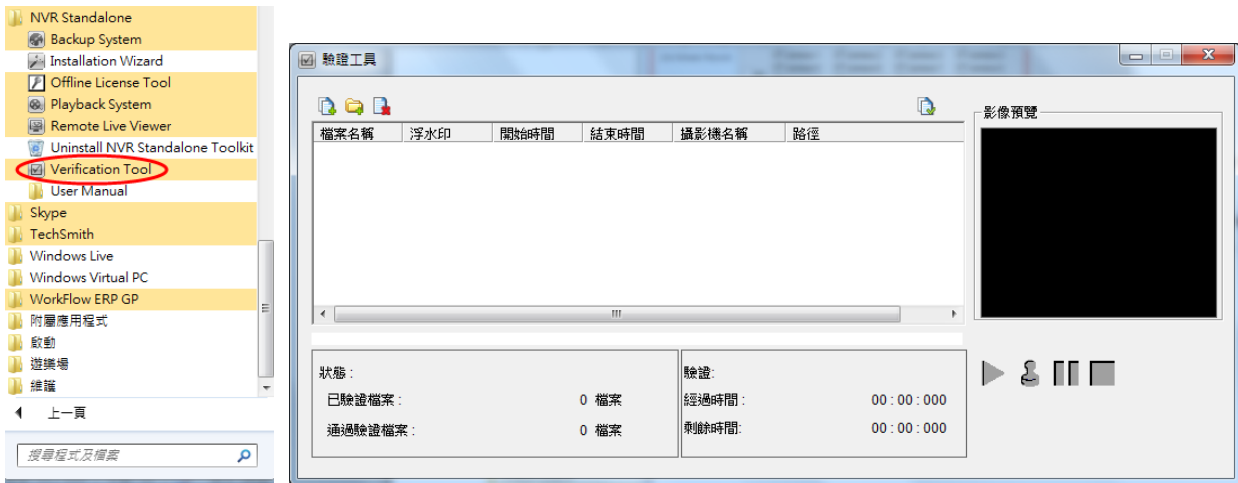

 When watermark enable, both streams will have this function, and vice versa.

 2nd stream playback only available on remote playback.

2.2.4 Camera Events and Responding Actions Setup

1. Open Internet Explorer, Mac Safari or Windows Chrome and log in to the unit.
2. Click **Recording & Event / Event & Action Management**.
3. Choose the camera, and then select one of the events. The event list depends on camera its own ability.

Event & Action Management

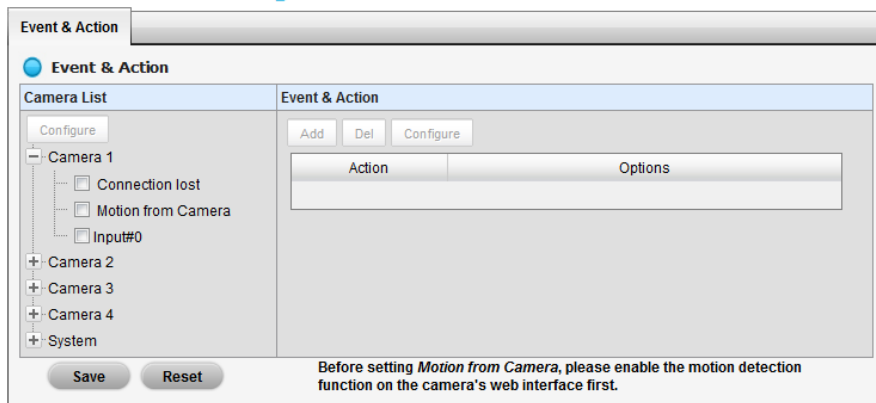

- **Connect lost**: When a connection between the camera and this unit is lost, the system will trigger an action.
- **Motion from Camera**: When motion is detected, an action can be triggered.

- **Input:** Any external input can trigger an action.



When setting the event Motion, if you prefer Motion (NVR), or embedded motion, please enable it from the local setting of the NVR.

If camera motion is preferred, please first ensure that the motion detection function of the camera has been enabled, and disable Motion(NVR) in local setting.

4. Click the **Configure** button to enable the event and select the active period.

The 'Event Configuration' dialog box contains the following elements:

- Enable Event
- Active Period:
 - Always Active
 - Active only in the following period
 - Time selection: 00:00 to 00:00
- IO Type:
 - N/O
 - N/C
- Buttons: OK, Cancel

- **Always Active:** The selected event is always active.
- **Active only in the following period:** The selected event is only active in the designated time, which able to cover two days e.g. from 18:00 to 09:00.
- **I/O Type:** Check one of the options of I/O type. N/O means normal open, while N/C means normal close.

5. Click the **Add** button to set up the responding actions of this event.

Event & Action Management

The interface shows the following components:

- Event & Action** (Selected)
- Camera List:** Location 1, Location 2, Location 3, Location 4, System. Under Location 1, 'Conn' and 'Motion' are visible.
- Event & Action:** Includes 'Configure', 'Add', 'Del', and 'Configure' buttons. A dropdown menu for 'Output' is open, showing options: Email, CMS, Push Notification, E-map popup.
- Action:** A table with columns for 'Action' and 'Options'.
- Buttons:** Save, Reset.
- Notes:**
 - Before setting *Motion from Camera*, please enable the motion detection function on the camera's web interface first.
 - Users have to sign in on mobile clients to start push notification service. If the user password is changed, please sign in with the new password to start the service again.

- **Output:** When an event occurs, the system will send an output signal to other connected devices.
 - **Email:** When an event occurs, the system will send Email notifications and a snapshot. Make sure to add an Email address first.
 - **CMS:** When an event occurs, the system will send out a signal and a snapshot to CMS. CMS will highlight this event.
 - **Push Notification:** When an event occurs, the system will send instant message to the registered mobile clients as a notification. Mobile users can check the recording videos on mobile client to watch what just happened. Refer to **Push Notification**.
 - **E-map popup:** When an event occurs, the system will pop up E-map with an event indicator to show users the location of the scene clearly.
 - **Snapshot to FTP:** When an event occurs, the system will upload snapshots to assigned FTP server. Refer to **camera support list**.
6. Click the action, and then click the **Configure** button to modify the details of that action if necessary.
 7. Click the **Save** button.



After selecting camera events, the event information will display on the screen when it's triggered.

2.2.5 I/O Box Input and Responding Action Setup

1. Open Internet Explorer, Mac Safari or Windows Chrome and log in to the unit.
2. Click **Recording & Event / Event & Action Management**.
3. Click the **Event & Action** tab.
4. Select an input of I/O Box from list.
5. Click the **Add** button to set up the responding actions of this event.
6. Click the action, and then click the **Configure** button to modify the details of that action if necessary.

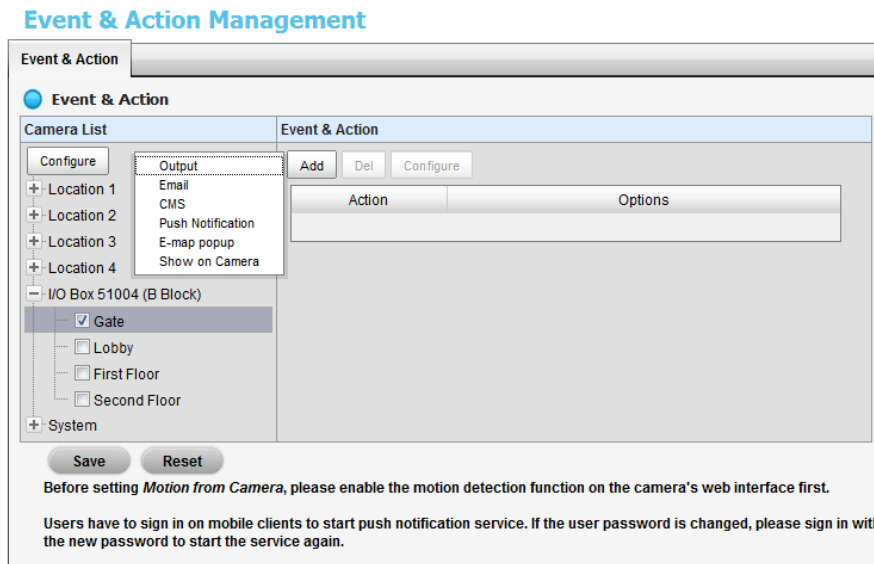

- **Output:** When an event occurs, the system will send an output signal to other connected devices.
- **Email:** When an event occurs, the system will send Email notifications. Make sure to add an Email address first.
- **CMS:** When an event occurs, the system will send out a signal to CMS. CMS will highlight this event.
- **Push Notification:** When an event occurs, the system will send instant message to the registered mobile clients as a notification. Mobile users can check the recording videos on mobile client to watch what just happened. Refer to **Push Notification**.
- **E-map popup:** When an event occurs, the system will pop up E-map with an event indicator to show users the location of the scene clearly.
- **Show on Camera:** When an event occurs, the system will show an alert message on selected camera(s) of screen.



7. Click the **Save** button.

2.2.6 System Events and Responding Actions Setup

1. Open Internet Explorer, Mac Safari or Windows Chrome and log in to the

unit.

2. Click **Recording & Event / Event & Action Management**.
3. Click the **Event & Action** tab.
4. Click **System** to unfold the list of system events, and then select one of the five events.

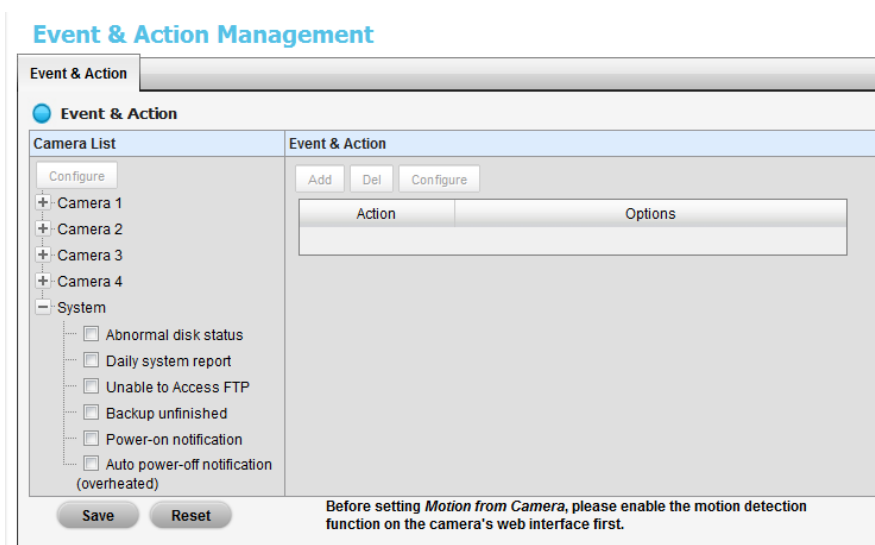

- **Abnormal disk status**: When there is no enough disk space for recording or when disk is abnormal for accessing, the system will trigger an action.
 - **Daily system report**: Enable users to know the system information, HDD usage, and Disk status everyday through Email without accessing to the unit to check.
 - **Unable to access FTP**: The action will be triggered when the connection between the unit and FTP server is lost.
 - **Backup unfinished**: If there is any file which the system didn't complete the backup process, the file(s) name will be listed and send out through Email after finishing the last file of this backup schedule.
 - **Power-on notification**: Record the time as power was turning on.
5. Click the **Add** button to set up the responding actions of this event. Follow the steps in the previous section.
 6. Click the **Save** button.



Email and Push Notification are the only two actions to the event **Daily system report**, **Unable to access FTP**, **Backup unfinished**, **Power-on notification** and **Auto power-off notification (overheat)**. In addition to select a contact, remember to insert the time of sending daily system report.

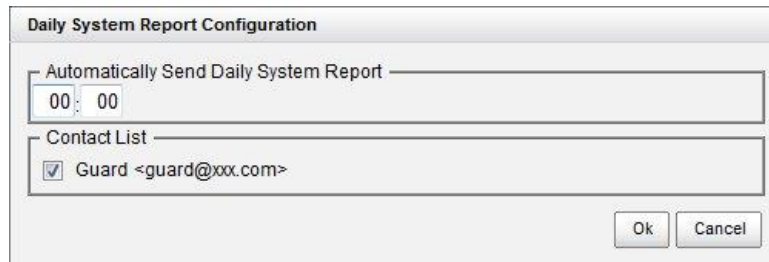

2.2.7 Push Notification

1. Open Internet Explorer, Mac Safari or Windows Chrome and log in to the unit.
2. Click **Recording & Event / Event & Action Management**.
3. Click the **Event & Action** tab.
4. Click **Add** tab
5. Add **Push Notification** as a responding action for an event. Configure the rearm interval and assign user(s).

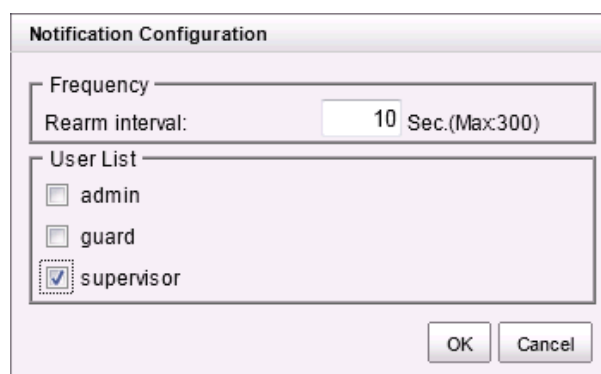
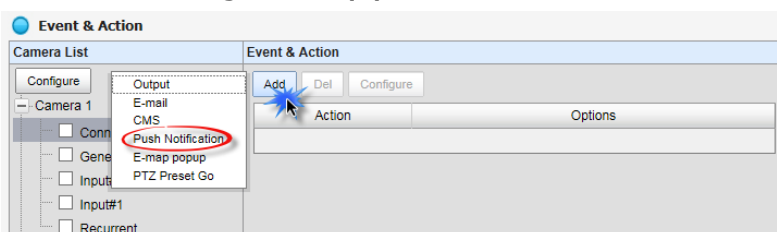

- **Frequency – Rearm interval**: The minimum interval of notifications as the event occurs. (default: 10, max: 300) For example, you set up push notification as the responding action for motion detection. When motion detected, it may trigger several alarms. In this case, you may not want to receive several push notifications frequently, then you can define the suitable rearm interval.
- **User List**: All user accounts in this unit.

6. Click the **Save** button.

Event & Action Management

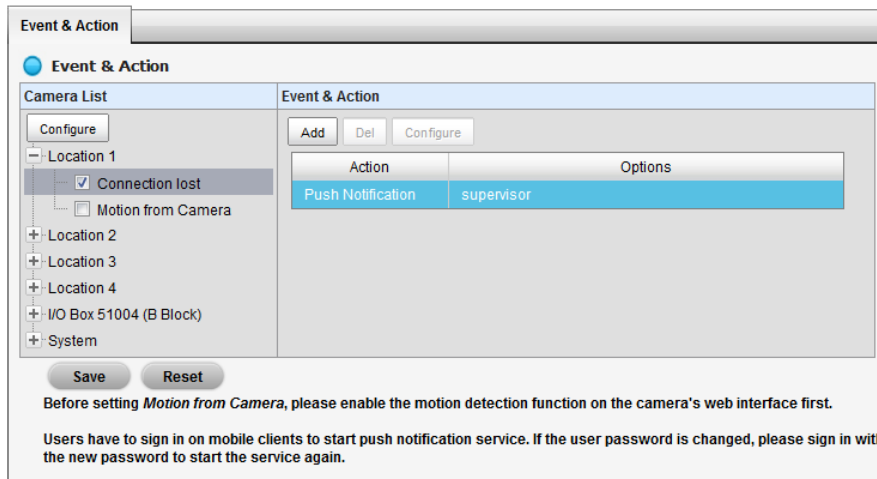

Event & Action

Event & Action

Camera List

Configure

Location 1

Connection lost

Motion from Camera

Location 2

Location 3

Location 4

I/O Box 51004 (B Block)

System

Event & Action

Add Del Configure

Action	Options
Push Notification	supervisor

Save Reset

Before setting *Motion from Camera*, please enable the motion detection function on the camera's web interface first.

Users have to sign in on mobile clients to start push notification service. If the user password is changed, please sign in with the new password to start the service again.

7. Sign in the unit on the mobile client with the user account assigned with push notification service.

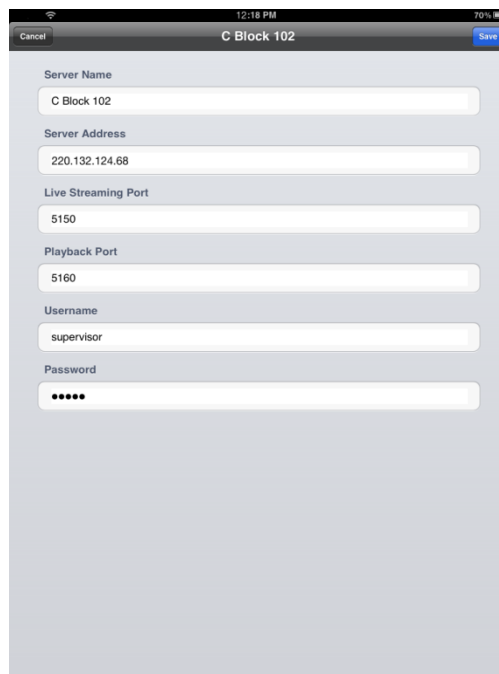

Cancel C Block 102 Save

Server Name
C Block 102

Server Address
220.132.124.68

Live Streaming Port
5150

Playback Port
5160

Username
supervisor

Password

8. When an event occurs, the user will get the push notification instantly. The user can click the "View" icon to watch the recording videos.

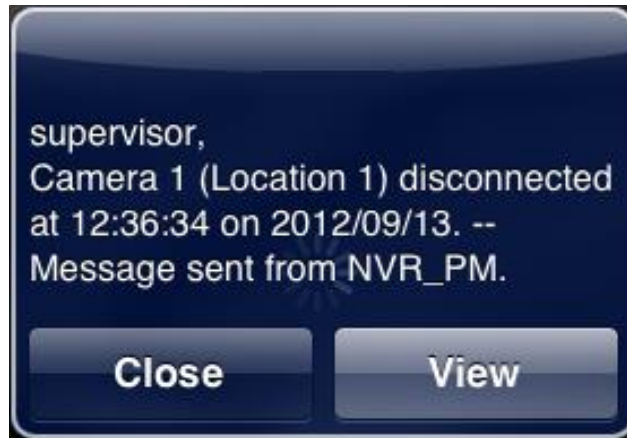

If the user password is changed, please sign in with the new password to start the service again.



If users don't want to **receive** notifications anymore, users can turn off this feature on the mobile client. There is one possibility of de-registering failed, that is, users have ever logged in to the mobile client by typing both LAN IP and WAN IP of the NVR, but only do de-registering on one side.



If users don't want to **send** notifications to certain user account, users can de-select the user account in Event & Action Management page.



User account won't be exported as saving configuration, which implies the user list of push notification won't be saved as well.

2.2.8 SMTP Server Setup

1. Open Internet Explorer, Mac Safari or Windows Chrome and log in to the unit.
2. Click **Recording & Event / Email**.
3. Click the **SMTP Server** tab.

Email

The screenshot shows a web interface for configuring an SMTP server. At the top, there are two tabs: 'SMTP Server' (selected) and 'Contacts'. Below the tabs, there is a section titled 'SMTP Server' with a blue circular icon. The form contains several fields: 'Server Address' (empty), 'Port' (465), and a checked checkbox for 'use SSL'. Below these are 'Sender' (empty), 'Subject' (NVR Event), and 'Body' (Some issue occurred! Please check the NVR server in B Block.). At the bottom, there is a checked checkbox for 'SMTP Authentication', 'Username' (empty), and 'Password' (empty). At the very bottom, there are three buttons: 'Save', 'Reset', and 'Send Test Mail'.

- **Server Address:** SMTP (Simple Mail Transport Protocol) server IP address.
- **Port:** SMTP port.
- **Sender:** Sender information.
- **Subject:** The subject of the mail.
- **Body:** Email content.
- **SMTP Authentication:** Before sending out an Email, enter the username and password for SMTP authentication.
- **Username**
- **Password**

4. Click the **Send Test Mail** button and the system will send a test mail to the sender. Check it after testing.
5. Click the **Save** button.

2.2.9 Add Event Contacts

1. Open Internet Explorer, Mac Safari or Windows Chrome and log in to the unit.
2. Click **Recording & Event / Email**.
3. Click the **Contacts** tab.

- **Add Contact:** Add this new contact into the contact list. (Maximum: 40 contacts)
- **Reset:** Return to the latest saved settings of the contact list.
- **Save:** Save this time modification of the contact list.

4. Insert the name of a new contact.
5. Insert the Email address of this new contact.
6. Click the **Add Contact** button.
7. Click the **Save** button to save this modification of the contact list.

2.2.10 Set up FTP Server

1. Open Internet Explorer, Mac Safari or Windows Chrome and log in to the unit.
2. Click **Recording & Event / FTP Settings**.
3. Set up the FTP server and create a folder for backup files. The folder format is "FolderName", "FolderName/SubFolderName", and so on.

For example: NVR

4. After setting up all the information, click the **Test FTP** button and the system will create a folder to FTP. Check it after testing. In this case, the route of the tested file will be: **ftp://www.ftp.com/NVR/NVR_ComputerName**

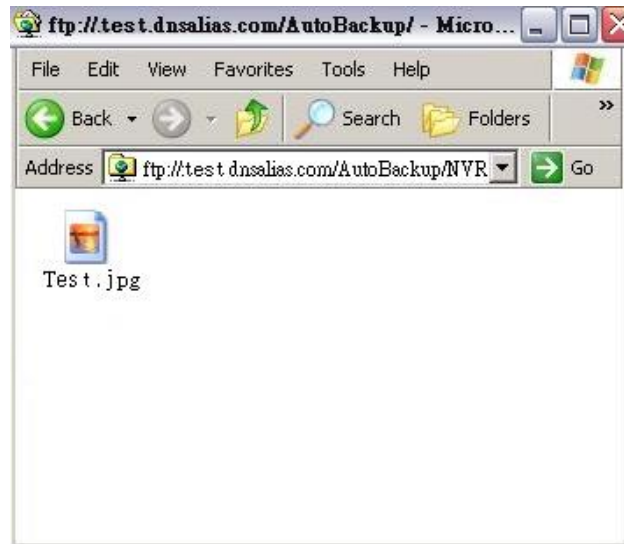

5. Click the **Save** button.



Make sure the FTP account with privileges of administrator who is able to upload, rewrite, delete files, and create new folder. Besides, make sure the FTP server has enough space for auto backup.



To avoid the failure of auto backup, please check the normality of FTP server regularly (e.g., enough space for video, system conditions.)

2.3 RAID & File Settings

2.3.1 Create a RAID Volume

In this system, the term RAID volume refers to one or more disk drives working together as a RAID logical drive. You must create a RAID volume before starting to record.

1. Open Internet Explorer, Mac Safari or Windows Chrome and log in to the unit.
2. Click **RAID & File System / RAID Management**.
3. Click the **Create** tab.

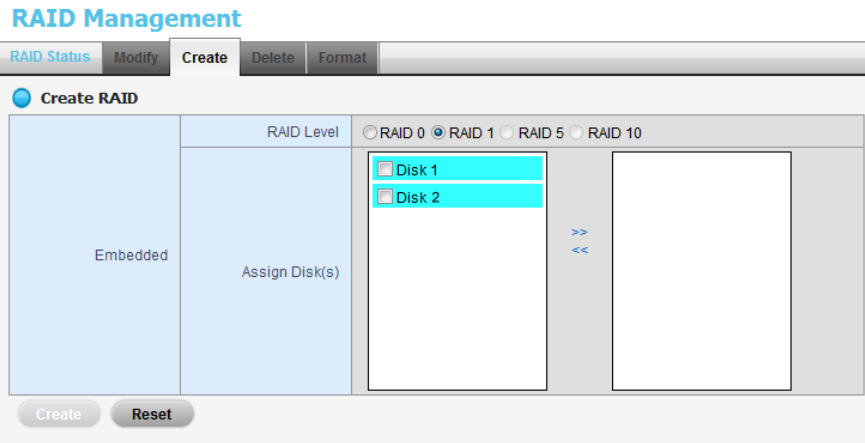

4. Choose the RAID level you prefer for your disk array.
5. Check boxes of disks and click the >> button to assign disk drives for this volume.
6. Click the **Create** button.
7. A confirmation dialog pops up. Check the **Yes, I want to create volume with those disk(s)** box, and click the **Yes, create it** button.

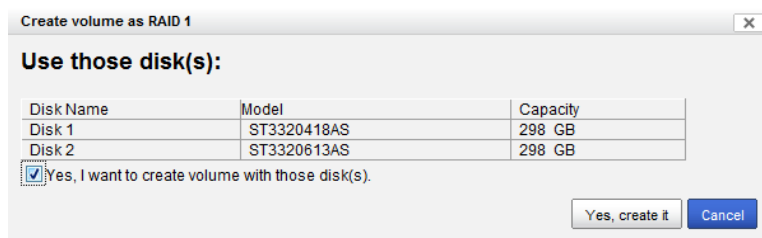

8. Creating RAID volume takes a while, depending on the size of disks and the RAID level you choose. You can start recording during RAID creation.

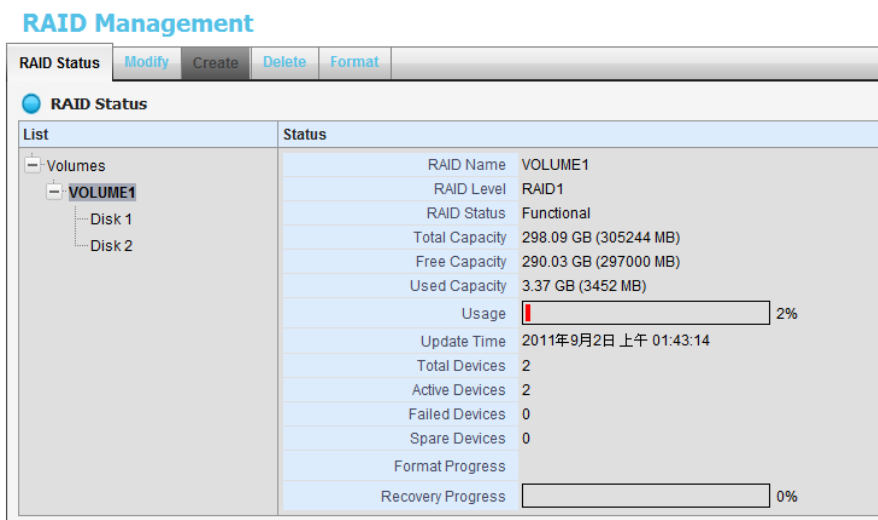



The RAID Volume will be functional on another unit if **all** disks of this volume are moved to the unit.



After setting RAID level, you are not allowed to change neither the RAID level nor the number of disks containing in this volume.



Separate embedded disk(s) and external disk (DAS) from two groups, which implies there is no way to create a single volume with both embedded and external disks inside.

In 8bay RAID model, the embedded disk(s) are separated to two groups. Each group management its own RAID volume.



To reduce the possibility of having problems to access public folder via My Network Places, before creating new disk volume or modifying volume, please delete the invalid volume if any.



If you choose Express Mode when using the **Installation Wizard**, the disk(s) will be set to RAID 0 automatically unless the number of disks is not enough for this RAID level.



To make sure all the information of hard disk and RAID volume are correct, 8bay RAID model are not allowed to query status, create, modify, delete, format RAID volume when the front panel is opened.



Not support disk hot swap on external storage currently. Please reboot the unit after the installation.

2.3.2 View RAID Volume Status

RAID status refers to the disk drives on your unit and how they are arranged into a RAID volume.

1. Open Internet Explorer, Mac Safari or Windows Chrome and log in to the unit.
2. Click **RAID & File System / RAID Management**.
3. Click the **RAID Status** tab to view the status of your RAID Volume.

RAID Management

The screenshot shows the RAID Management interface with the RAID Status tab selected. The interface displays a tree view on the left under 'Volumes' with 'VOLUME2' selected, showing 'Disk 2' and 'VOLUME1' (with 'Disk 1') as sub-items. The main area shows the RAID status for VOLUME2:

List	Status
RAID Name	VOLUME2
RAID Level	RAID0
RAID Status	Functional
Total Capacity	298.08 GB (305244 MB)
Free Capacity	289.87 GB (296832 MB)
Used Capacity	3.53 GB (3620 MB)
Usage	<div style="width: 2%;"><div style="width: 2%;"></div></div> 2%
Update Time	2011年9月2日 下午 06:34:32
Total Devices	1
Active Devices	1
Failed Devices	0
Spare Devices	0
Format Progress	
Recovery Progress	

- **RAID Name:** Name of your RAID, automatically assigned when it was created.
- **RAID Level:** RAID 0, 1, 5, or 10, specified when it was created.
- **RAID Status:** **Functional** is normal. **Critical** means there are some problems on RAID volume, but the recording status is normal. **Offline** means that no volume is found, so recording is stopped and you cannot access your data either. **File system error** means that RAID volume is existed but unmounted, so recording is stopped and you cannot access your data either.
- **Capacity:** Total, free, used data capacity of the RAID volume.
- **Update Time:** The time of volume created/updated.
- **Devices:** Total number of disks and the number of active, failed, spare disks.
- **Format Progress:** The status of RAID format
- **Recovery Progress:** The status of RAID recovery





To make sure all the information of hard disk and RAID volume are correct, 8bay RAID model are not allowed to query status, create, modify, delete, format RAID volume when the front panel is opened.

2.3.3 View Disk Drive Information

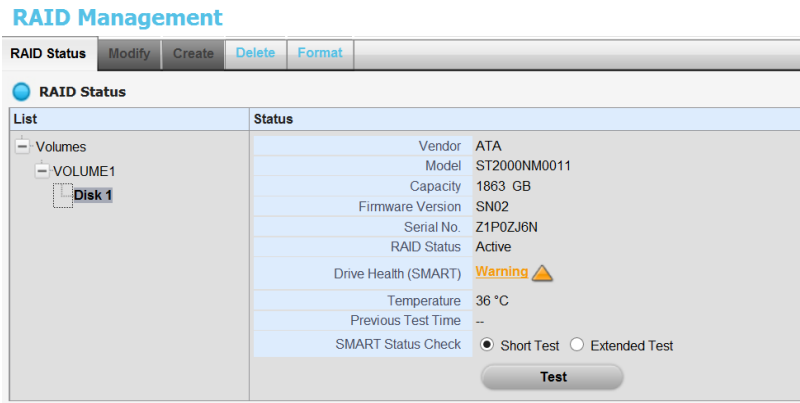
1. Open Internet Explorer, Mac Safari or Windows Chrome and log in to the unit.
2. Click **RAID & File System / RAID Management**.
3. Click the **RAID Status** tab.
4. Click on a disk directly to view the information.



- **Vendor:** Delivers the manufacturer of the disk.
- **Model:** Delivers the model number of the disk.
- **Capacity:** Total, free, used data capacity of the disk.
- **Firmware:** Delivers the firmware version of the disk.
- **Serial No.:** Delivers the serial number of the disk.
- **RAID Status:** Delivers the status of the RAID that the disk belongs to.
- **Drive Health (SMART):** Delivers the status of drive health by SMART self-test. The results will show as follows. Click on the icon to view the detail SMART test report.

Icon	Status	Details
	Good	The disk is healthy and able to work normally.
	Warning	The disk is damaged. Recommend you to change the disk as soon as possible.
	Abnormal	The disk is damaged seriously and it may cause the system errors. Strongly recommend you to stop recording and change the disk immediately.

- **Temperature:** Delivers the temperature of the disk.
- **Previous Test Time:** Delivers the previous SMART self-test time.
- **SMART Status Check:** Run SMART test to update the Drive Health result. The test divides into 2 modes, **Short Test** and **Extended Test**. Both of the test modes may affect the recording performance. You may need to stop recording to run the test.

5. Enable and click on **Test** button to run SMART test.

RAID Management

The screenshot shows the RAID Management interface. Under the 'RAID Status' tab, a tree view on the left shows 'Volumes' > 'VOLUME1' > 'Disk 1'. The main area displays the status of the selected disk. The 'Drive Health (SMART)' is shown as 'Warning' with a yellow triangle icon. Other details include: Vendor: ATA, Model: ST2000NM0011, Capacity: 1863 GB, Firmware Version: SN02, Serial No.: Z1P0ZJ6N, RAID Status: Active, Temperature: 36 °C, Previous Test Time: 2014年3月17日 下午 06:30:08, and SMART Status Check: 10% (represented by a green progress bar). A 'Stop Test' button is located at the bottom right of the status area.



SMART test may affect the recording performance. You may need to stop recording to run the test.



Click on **Stop Test** to terminate SMART test.

6. Click on **Drive Health (SMART)** to view the details.

SMART Details

ID	Attribute	Status	Raw	Value	Threshold	Worst
1	Raw Read Error Rate	Good	d536cbc	83	44	63
3	Spin-Up Time	Good	0	92	0	90
4	Start / Stop Count	Good	82	100	20	100
5	Reallocated Sector Count	Warning	1	100	36	100
7	Seek Error Rate	Good	280e6219ba	68	30	60
9	Power-On Time	Good	13f6	95	0	95
10	Spin-Up Retry Count	Good	0	100	97	100
12	Power Cycle Count	Good	79	100	20	100
184	End to End Error	Good	0	100	99	100
187	Reported Uncorrectable	Good	0	100	0	100
188	Command Timeout	Good	0	100	0	100
189	High Fly Writes	Good	0	100	0	100
190	Airflow Temperature	Good	22	66	45	54
191	G-Sense Error Rate	Good	37	100	0	100
192	Head Retract Cycle Count	Good	5d	100	0	100
193	Load / Unload Cycle	Good	612	100	0	100
194	Temperature (Celsius)	Good	22	34	0	46
195	Hardware ECC Recovered	Good	d536cbc	119	0	99
197	Current Pending Sector Count	Good	0	100	0	100
198	Offline Uncorrectable	Good	0	100	0	100
199	UDMA CRC Error Count	Good	0	200	0	200

OK

7. Click on **OK** button to exit.

2.3.4 Modify RAID Volume

This function is designed for replacing a broken hard drive with a new one, instead of modifying RAID level.

In the condition of critical RAID status, it's a warning to show that one of disks of this RAID volume may be damaged. Even though it's no impact on the recording function, you'd better to replace a new disk to make sure the volume with data protection mechanism.



This function is not applied to RAID 0, since there is no data protection mechanism by its nature.



In case of any unexpected damage, we recommend users to unplug running HDD by this method, which can be viewed as security hard drive remove.

1. Open Internet Explorer, Mac Safari or Windows Chrome and log in to the unit.
2. Click **RAID & File System / RAID Management**.
3. Click the **Modify** tab.

RAID Management

RAID Status **Modify** Create Delete Format

RAID List

Volume	RAID Level	RAID Capacity	RAID Status	Details
VOLUME1	RAID1	298.09 GB	Critical	Details

Free Disk List

Disk Name	Model	Capacity	Details
Disk 2	ST3320613AS	298 GB	Details

Modify Volume

RAID Name	
RAID Level	
Capacity	
RAID Status	
Actions	<input type="radio"/> Remove Disk <input type="radio"/> Add Disk

Modify Reset

4. Click on the volume you want to modify. The information of this volume will be displayed under the **Modify Volume** section.

RAID Management

RAID Status **Modify** Create Delete Format

RAID List

Volume	RAID Level	RAID Capacity	RAID Status	Details
VOLUME1	RAID1	298.09 GB	Critical	Details

Free Disk List

Disk Name	Model	Capacity	Details
Disk 2	ST3320613AS	298 GB	Details

Modify Volume

RAID Name	VOLUME1
RAID Level	RAID1
Capacity	298.09 GB
RAID Status	Critical
Actions	<input type="radio"/> Remove Disk <input checked="" type="radio"/> Add Disk <input checked="" type="radio"/> Disk 2: 298 GB ST3320613AS

Modify Reset

5. After removing the damaged disk. Add a free disk to replace the damaged, and click the **Modify** button.
6. A confirmation dialog pops up. Check the **Yes, I want to modify this volume** box, and click the **Yes, modify it** button.

Modify Volume

Are you sure to modify this volume?

RAID Name	VOLUME1
RAID Level	RAID1
Capacity	298.09 GB
RAID Status	Functional
Assigned Disks	Disk 1 298 GB ST3320418AS Disk 2 298 GB ST3320613AS

Action for modifying volume:

Remove Disk

Disk 2 298 GB ST3320613AS SD22 9SZ0KN70 Active

Yes, I want to modify this volume.

Yes, modify it Cancel

7. Modifying RAID volume takes a while, depending on the size of disks you choose. Recording won't be stopped during the modification, and the data of this RAID volume is fully accessible.

RAID Management

The screenshot shows the RAID Management interface with the 'RAID Status' tab selected. The 'RAID Status' section displays a tree view on the left with 'VOLUME1' expanded, showing 'Disk 1' and 'Disk 2'. The main area shows the status for 'VOLUME1' with the following details:

RAID Name	VOLUME1
RAID Level	RAID1
RAID Status	Functional
Total Capacity	298.09 GB (305244 MB)
Free Capacity	289.87 GB (296832 MB)
Used Capacity	3.53 GB (3620 MB)
Usage	<div style="width: 2%;"><div style="width: 2%;"></div></div> 2%
Update Time	2011年9月2日 下午 06:26:54
Total Devices	2
Active Devices	1
Failed Devices	0
Spare Devices	1
Format Progress	<div style="width: 8%;"><div style="width: 8%;"></div></div>
Recovery Progress	<div style="width: 8%;"><div style="width: 8%;"></div></div> 8%



To make sure all the information of hard disk and RAID volume are correct, 8bay RAID model are not allowed to query status, create, modify, delete, format RAID volume when the front panel is opened.

2.3.5 Delete a RAID Volume

1. Open Internet Explorer, Mac Safari or Windows Chrome and log in to the unit.
2. Click **RAID & File System / RAID Management**.
3. Click the **Delete** tab.

RAID Management

The screenshot shows the RAID Management interface with the 'Delete' tab selected. The 'RAID List' section displays a table with the following data:

	Volume	RAID Level	RAID Capacity	RAID Status	Details
<input checked="" type="radio"/>	VOLUME2	RAID0	298.08 GB	Functional	Details
<input type="radio"/>	VOLUME1	RAID0	298.08 GB	Functional	Details

Below the table are two buttons: **Delete** and **Reset**.

4. Click the option button beside the RAID Volume you want to delete.
5. Click the **Delete** button.
6. A confirmation dialog pops up. Check the **Yes, I want to delete this volume** box, and click the **Yes, delete it** button.

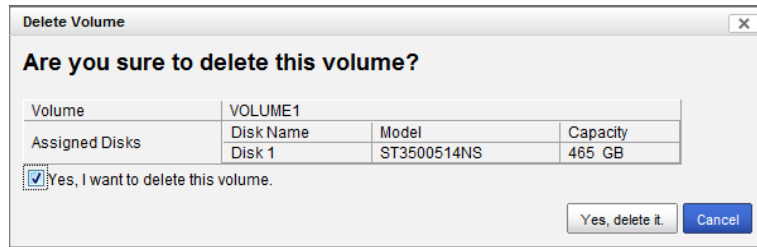

7. System will restart automatically after RAID volume is deleted

 When you delete a RAID Volume, all the folders in the RAID volume and all the data saved in the folders will be deleted. Backup any important data before deleting a RAID Volume.

 To make sure all the information of hard disk and RAID volume are correct, 8bay RAID model are not allowed to query status, create, modify, delete, format RAID volume when the front panel is opened.

2.3.6 Format

Neither pressing reset button nor loading default setting, the data of RAID volume won't be deleted, which implies that format is the only way to clean the RAID information from disks.

1. Open Internet Explorer, Mac Safari or Windows Chrome and log in to the unit.
2. Click **RAID & File System / RAID Management**.
3. Click the **Format** tab.

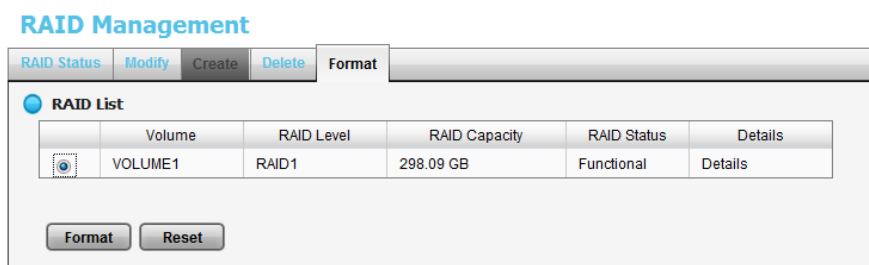

4. Click the option button beside the RAID Volume you want to format.
5. Click the **Format** button.
6. A confirmation dialog pops up. Check the **Yes, I want to format this volume** box, and click the **Yes, format it** button.

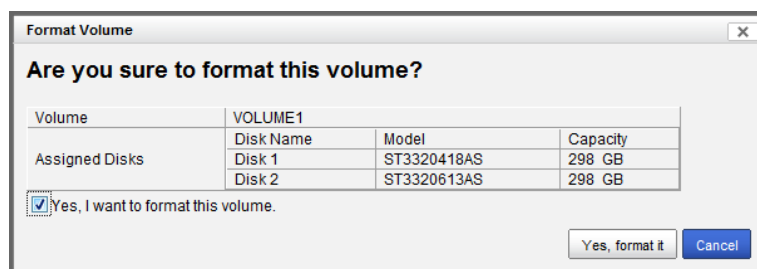

7. System will restart automatically after volume format is complete.



To make sure all the information of hard disk and RAID volume are correct, 8bay RAID model are not allowed to query status, create, modify, delete, format RAID volume when the front panel is opened.

2.3.7 Modify the FTP Protocol Settings

1. Open Internet Explorer, Mac Safari or Windows Chrome and log in to the unit.
2. Click **RAID & File System / Protocol Control**.
3. Click the **FTP Sharing** tab.
4. Check and enter the settings of this unit.
5. Click the **OK** button.

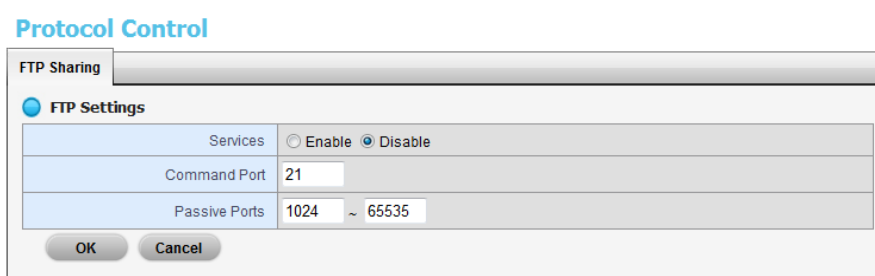

- **Services:** Whether users can access this unit through FTP or not.
- **Command Port:** The port for commands between a server and a client.
- **Passive Ports:** The data transmission port of passive mode.

2.4 Auto Backup

This feature enables you to automatically backup the recorded video of the previous date to FTP site. There are two steps to enable the function, one is **Set up Backup Schedule**, another is **Set up Backup Server**.

2.4.1 Set up Backup Schedule

1. Open Internet Explorer, Mac Safari or Windows Chrome and log in to the unit.
2. Click **RAID & File System / Auto Backup Management**.
3. Click the **Backup Schedule** tab.
4. Set up backup schedule, select the backup channels, and check the **Enable** option to enable **Auto Backup**.

Auto Backup Management

Backup Schedule | Backup Server

Backup Schedule

Auto Backup	<input checked="" type="checkbox"/> Enable
Daily Backup Time	00 : 00
Video Start Time	07 : 00
Video End Time	18 : 00
Camera	select: all / none <input checked="" type="checkbox"/> Camera 1 <input checked="" type="checkbox"/> Camera 2 <input checked="" type="checkbox"/> Camera 3 <input checked="" type="checkbox"/> Camera 4

Current Event Settings

Unable to access FTP	disable
Backup Unfinished	disable

Save Reset

- **Auto Backup**: Check the **Enable** option to enable this function.
 - **Daily Backup Time**: The daily scheduled time to start backup process.
 - **Video Start Time**: The start time of recorded video of the previous date.
 - **Video End Time**: The end time of recorded video of the previous date.
 - **Camera**: Select the channel(s) to backup.
5. **Current Event Settings** shows the condition of the events of auto backup – enable or disable. Follow the steps of **System Events and Responding Actions Setup** to configure the event & action.



The system backs up recorded video files one by one. If the connection between the unit and FTP server is normal, but some problems of FTP causes the system unable to write files on FTP, the system would try each file three times before starting to backup the next file. If the connection is lost, the system would wait for the connection, so no file would be skipped.



Please make sure the network is stable and the bandwidth is more than 2 Mbps for backup videos.

2.5 Network Setup

2.5.1 View Network Status

1. Open Internet Explorer, Mac Safari or Windows Chrome and log in to the unit.
2. Click **Network Setup / Network Setup**.
3. Click the **Information** tab to view the unit's network information.

Network Setup

Information	Setup	DDNS Setup	UPnP Port Forwarding
Common Information			
Server Name	NVS-4		
Ethernet Adapter 1 Information			
IP Address	192.168.4.137		
Subnet Mask	255.255.252.0		
Default Gateway IP Address	192.168.4.1		
Primary DNS	192.168.4.1		
Secondary DNS			
Ethernet Adapter 2 Information			
IP Address			
Subnet Mask			
Default Gateway IP Address			
Primary DNS			
Secondary DNS			
Built-in DHCP Information			
Setting/Status	Always disable (Disable)		
IP Address	192.168.4.137		

2.5.2 Network Settings

1. Open Internet Explorer, Mac Safari or Windows Chrome and log in to the unit.
2. Click **Network Setup / Network Setup**.
3. Click the **Setup** tab to set up the network settings of your unit.

Network Setup

Information	Setup	DDNS Setup	UPnP Port Forwarding
Common Setting			
Server Name	NVS-4		
Internet Interface (WAN)	LAN 1		
LAN 1 Setting			
Internet Protocol	<input checked="" type="radio"/> Obtain an IP address automatically <input type="radio"/> Specify an IP address		
IP Address	192.168.4.65		
Subnet Mask	255.255.252.0		
Default Gateway IP Address	192.168.4.1		
Primary DNS			
Secondary DNS			
LAN 2 Setting			
Internet Protocol	<input checked="" type="radio"/> Obtain an IP address automatically <input type="radio"/> Specify an IP address		
IP Address	192.168.2.100		
Subnet Mask	255.255.255.0		
Default Gateway IP Address	192.168.2.1		
Primary DNS	192.168.2.1		
Secondary DNS			
Built-in DHCP Setting			
Setting	<input type="radio"/> Smart enable <input checked="" type="radio"/> Always disable		
IP Address			
Subnet Mask			
Default Gateway IP Address			
Primary DNS			
Secondary DNS			
Starting IP Address			
Ending IP Address			
OK Cancel			

- **Server Name:** Name your unit.



Because of the internal data modifications required, it takes a few seconds to change the name of your unit. Log in again after configuration activated.

-
- **Internet Interface (WAN):** The selection is for choosing which LAN is connected to the internet, which implies that there is no longer to fix the Internet access to LAN 1 for sending mails, activating license online, receiving auto upgrade notification, etc.
- **Internet Protocol:** Choose to obtain an IP address from external DHCP server automatically, or configure the IP address manually.
- **IP Address:** IP address of this unit.
- **Subnet Mask:** Subnet mask address.
- **Default Gateway IP Address:** Gateway IP address.
- **Primary DNS:** Primary DNS (Domain Name System) address.
- **Secondary DNS:** Secondary DNS address.



The unit specifies two Giga LANs. We recommend using them under the scenario of two subnets, one is for cameras/devices, and the other is for remote access. If you deploy two LANs on the same subnet, it's likely to make parts of camera disconnected as either one of LAN is disconnected.



If all cameras are disconnected, please check if the network settings are

- LAN 1: static IP 192.168.1.100 (default) / not connected
- LAN 2: DHCP / connected to switch, which subnet is 192.168.1.X or static IP 192.168.1.X / connected to switch, which subnet is 192.168.1.X

The reason of disconnection is that system transmits package via LAN 1 in such condition. The solution is changing the LAN 1 settings to DHCP or connecting network cable on LAN 1.

4. The unit possesses built-in DHCP service, which enables the system to dynamically assign IP addresses to the connected camera clients within the same subnet.
 - **Setting:** Two options of built-in DHCP service, smart enable and always disable. When you have router in your network, we strongly recommend choosing "always disable" to avoid any IP conflicts. If you are not sure if there is any router in your network, please choose "smart enable", which detects the network environment then decide to enable or disable the service.
 - **Starting IP Address:** The IP address for the built-in DHCP to start assigning from.
 - **Ending IP Address:** The end of the IP address that the built-in DHCP assigns.
5. If you are using findNVR service. You can skip the DDNS setup. For more information, please refer to [findNVR](#).
6. Click the **DDNS Setup** tab to enable Dynamic Domain Name Server function, allowing you to connect unit with dynamic IP address.

Network Setup

Information Setup **DDNS Setup** UPnP Port Forwarding

Dynamic DNS Setting

DDNS	<input type="checkbox"/> Enable
Provider	DynDns
User name	<input type="text"/>
Password	<input type="text"/>
Host name	<input type="text"/>
Update Period	16 minutes

Save Reset

2.5.3 Auto Port-Forwarding

If you are using findNVR service. You can skip this section. For more information, please refer to [findNVR](#).

This function is designed for saving time in port configuration on router if users want to access the unit (in LAN) from WAN. Once enabling UPnP Service on router, users can do port-forwarding for setting page (default: 80), liveview (default: 5150), playback (default: 5160), and CMS (default: 5170) automatically.

1. Open Internet Explorer, Mac Safari or Windows Chrome and log in to the unit.
2. Click **Network Setup / Network Setup**.
3. Click the **UPnP Port-Forwarding** tab.
4. Click the **Search** button, and the searched routers will be listed.

Network Setup

Information Setup **DDNS Setup** **UPnP Port Forwarding**

UPnP Router Search

Search Search complete

No.	Device Name	IP Address	
1	D-Link DIR-300	192.168.8.1	+

UPnP Port Forwarding List

Physical Port	Virtual IP	Virtual Port
---------------	------------	--------------

5. Select the searched router, and all UPnP ports configured on this router will show under the **UPnP Port Forwarding List**.

Network Setup

Information Setup DDNS Setup **UPnP Port Forwarding**

UPnP Router Search

Search Search complete

No.	Device Name	IP Address	LAN	
1	D-Link DIR-300	192.168.8.1	LAN1 (192.168.8.82)	+
2	D-Link DAP-1360		LAN1 (192.168.8.82)	+

UPnP Port Forwarding List

Physical Port	Virtual IP	Virtual Port
18403	192.168.9.55	80
554	192.168.9.55	554
80	192.168.9.159	80
26674	192.168.8.226	26673
1938	192.168.8.50	5868
33561	192.168.8.198	33561
33561	192.168.8.198	33561
7800	192.168.8.238	6663
65133	192.168.8.222	65133
14860	192.168.8.205	14860
14860	192.168.8.205	14860
26673	192.168.8.226	26673
26673	192.168.8.226	26673

6. After selecting one of searched routers, click the  icon to set up port-forwarding to this router automatically. You will find ports of setting, liveview, playback and CMS are listed.

Network Setup

Information Setup DDNS Setup **UPnP Port Forwarding**

UPnP Router Search

Search Search complete

No.	Device Name	IP Address	LAN	
1	D-Link DAP-1360		LAN1 (192.168.8.82)	+

UPnP Port Forwarding List

Physical Port	Virtual IP	Virtual Port
18910	192.168.8.238	18910
18910	192.168.8.238	18910
14861	192.168.1.190	14860
554	192.168.9.55	554
18403	192.168.9.55	80
33561	192.168.8.198	33561
33561	192.168.8.198	33561
26673	192.168.8.226	26673
26673	192.168.8.226	26673
14860	192.168.8.205	14860
14860	192.168.8.205	14860
64315	192.168.8.222	64315
64315	192.168.8.222	64315
8126	192.168.1.234	8126
8126	192.168.1.234	8126
80	192.168.8.82	80
5150	192.168.8.82	5150
5160	192.168.8.82	5160
5170	192.168.8.82	5170



For security reason, the privilege of UPnP port-forwarding is LOWER than port-forwarding configured on router. Therefore, if the ports have been used on router, we are unable to know before finding out access failure.



UPnP port-forwarding is for temporarily use only. Most of UPnP router will clean up all UPnP ports after router reboots. Furthermore, for some routers, if the port you want to add has already been used for other devices in the same way (UPnP port forwarding), this “enable” action will cover over the settings.

2.5.4 Network Service Setup

1. Open Internet Explorer, Mac Safari or Windows Chrome and log in to the unit.
2. Click **Network Setup / Network Service**.
3. Click the **Web Service** tab
4. Set up a port for this unit and click the **Save** button.

Network Service

Web Service | **Live View & Playback Service** | CMS Service

Web Server

Management Port:

5. Click the **Live View & Playback Service** tab.

Network Service

Web Service | **Live View & Playback Service** | CMS Service

Live Streaming Server

Port:

Maximum Connections:

Playback Server

Port:

Maximum Users:

Log Access: Enable

Black/White List

White List: Enable

Black List: Enable

IP Range: to

Index	IP	Access	Delete

- **Live Streaming Server**

- **Port**: Live streaming transmission port.
- **Maximum Connections**: Maximum connections from remote access. (Max: 64)

- **Playback Server**
 - **Port**: Playback transmission port.
 - **Maximum Users**: The number of users who can access playback functions at the same time. (Max: 8)
 - **Log Access**: Check to record playback access information on NVR Log page, including access time, playback video channels, and time frame.
- **Allowed/ Blocked List**
 - **Allowed List**: Only IP addresses from the allowed list are allowed to log in.
 - **Blocked List**: IP addresses from the blocked list will be unable to log in.



When setting Maximum Connections in Live Streaming Server settings, 1 connection means that one user connects to one camera. If the maximum connections value is set to 16, and each user connects to 4 cameras, the allowed connections per user will become 4, rather than 16.

2.5.5 CMS Service Setup

1. Open Internet Explorer, Mac Safari or Windows Chrome and log in to the unit.
2. Click **Network Setup / Network Service**.
3. Click the **CMS Service** tab.

Network Service

Web Service | Live View & Playback Service | **CMS Service**

● **CMS Server**

CMS Server	<input type="checkbox"/> Enable
Port	5170
Maximum Connections	8

Save Reset

- **CMS Server**: Check the **Enable** option to enable CMS service.
- **Port**: the port number through which the CMS connects to this unit.
- **Maximum Connections**: The maximum number of allowed CMS connections.

2.5.6 findNVR

findNVR is designed to truly simplify the process of establishing Internet access to NVR systems. It eliminates the need for setting up port forwarding and configuring DDNS. Simply register a server ID on the setting page, then

go to findNVR website or sign in iSecurity App to watch live videos and playback from wherever you are.

1. Open Internet Explorer, Mac Safari or Windows Chrome and log in to the unit.
2. Click **Network Setup / findNVR Registration**.
3. Click the **Registration** tab.

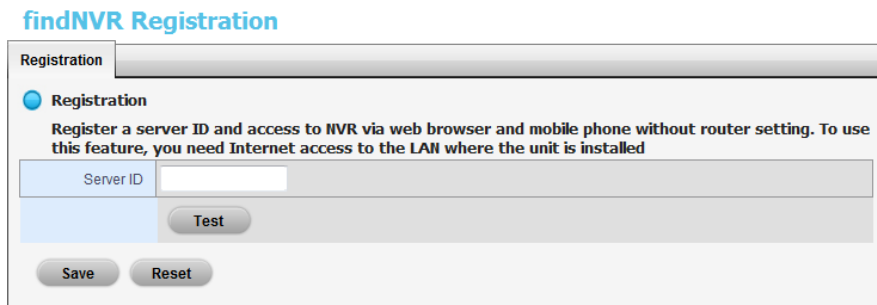

4. Enter a desired server ID in the Server ID field.
5. Click the **Test** button to check the availability of the desired server ID.
6. Click the **Save** button.
7. Now you can login to www.findnvr.com on a web browser to configure, watch live videos and playback with any other settings, such as port forwarding or DDNS setup. All you need to know is the server ID, username and password. What's more, you can also sign in to mobile app iSecurity to watch live videos and playback from everywhere you are.



To support to access to the NVR system via mobile app iSecurity, you have to upgrade the iSecurity to v3.0 or above.

2.6 Management

2.6.1 View the List of Users

1. Open Internet Explorer, Mac Safari or Windows Chrome and login the unit.
2. Click **Management/ User Management**.
3. Click the **Create New Users** tab.
4. The list will be displayed on the bottom of the page.

No.	Name	Group	Live View	Playback	Local Sign-in	Local Configuration	Backup Data	Delete Data
1	supervisor	power user	1,2,3,4	1,2,3,4	<input type="radio"/>	<input type="radio"/>	<input type="radio"/>	<input type="radio"/>
2	guard	user	1,2,3,4	1,2,3,4	<input type="radio"/>	<input checked="" type="radio"/>	<input type="radio"/>	<input checked="" type="radio"/>
3	temp	guestuser	1,2,3,4		<input checked="" type="radio"/>	<input checked="" type="radio"/>	<input checked="" type="radio"/>	<input checked="" type="radio"/>

2.6.2 Create New Users

1. Open Internet Explorer, Mac Safari or Windows Chrome and login the unit.
2. Click **Management/ User Management**.
3. Click the **Create New Users** tab.

User Management

Create New Users | Modify Users | Change Password

Create User

Username:

Password:

Group: power user

Live View Access: All Channel 1 Channel 2 Channel 3 Channel 4

Playback Access: All Channel 1 Channel 2 Channel 3 Channel 4

Local Privilege: Local Sign-in PTZ Control Configuration Stream Override Talk

Remote Privilege: PTZ Control IO Control E-map Settings
 Backup Data Delete Data Talk

Advanced: Browse log

Create New User | Clear

4. Insert the username of this new user.
 5. Insert the password of this new user.
 6. Choose the group of this user.
- **Power user**: Power user can do all the settings except the **Network Settings, RAID Settings, and Management function**.
 - **User**: User just can change his/her password and do the live view and playback functions.
 - **Guest user**: User can do live view and playback function only.

7. Select the live view cameras which this user can access.
8. Select the playback channels which this user can access.
9. Check whether this user can backup or delete recorded data.
10. Check whether this user can browse log or not.
11. Click the **Create New User** button to finish it.



The Administrator will be the only user who can use all of the functions. There is a default administrator account in the system, and you cannot create neither another "Administrator" account, nor another username named "admin".

2.6.3 Modify User Information

1. Open Internet Explorer, Mac Safari or Windows Chrome and log in to the unit.
2. Click **Management / User Management**.
3. Click the **Modify Users** tab.
4. Click one of the users in the User List on the bottom of this page.

User Management

Create New Users **Modify Users** Change Password

Modify Users

Username: guard

Group: user

Live View Access: All Channel 1 Channel 2 Channel 3 Channel 4

Playback Access: All Channel 1 Channel 2 Channel 3 Channel 4

Local Privilege: Local Sign-in PTZ Control Configuration

Remote Privilege: PTZ Control IO Control E-map Settings
 Backup Data Delete Data

Modify User Clear

User List

No.	Name	Group	Live View	Playback	Local Sign-in	Local Configuration	Backup Data	Delete Data	
1	supervisor	power user	1,2,3,4	1,2,3,4	O	O	O	O	
2	guard	user	1,2,3,4	1,2,3,4	O	X	O	X	
3	temp	guestuser	1,2,3,4		X	X	X	X	

5. Change the group of this user.
6. Select the live view cameras which this user can access.
7. Select the playback channels which this user can access.
8. Check whether this user can backup or delete recorded data.
9. Click the **Modify User** button to finish it.

2.6.4 Change a User's Password

1. Open Internet Explorer, Mac Safari or Windows Chrome and log in to the unit.
2. Click **Management / User Management**.
3. Click the **Change Password** tab.

The screenshot shows the 'User Management' interface with the 'Change Password' tab selected. The form contains the following elements:

- Tab headers: 'Create New Users', 'Modify Users', and 'Change Password'.
- Section title: 'Change Password'.
- Username field: A dropdown menu showing 'guard'.
- New Password field: An empty text input box.
- Retype Password field: An empty text input box.
- Buttons: 'OK' and 'Clear'.

4. Choose the user.
5. Enter a new password.
6. Enter this new password again.
7. Click the **OK** button.

2.6.5 Delete Users

Except for the administrator, you can delete any users with the following steps.

1. Open Internet Explorer, Mac Safari or Windows Chrome and log in to the unit.
2. Click **Management / User Management**.
3. Click the **Modify Users** tab.
4. Click the Delete icon of the user you want to delete.

No.	Name	Group	Live View	Playback	Local Sign-in	Local Configuration	Backup Data	Delete Data
1	supervisor	power user	1,2,3,4	1,2,3,4	O	O	O	O
2	guard	user	1,2,3,4	1,2,3,4	O	X	O	X
3	temp	guestuser	1,2,3,4		X	X	X	X

5. In the confirmation box, click the **OK** button.

2.6.6 Online License Activation

There are two types of license currently, camera license and POS license. With the camera license upgrade, the 4ch-device will possess up to 8ch capacity, while the 6ch-device will possess up to 16ch. With the POS license upgrade,

users can use **POS function**.

There are two ways to activate license, online and offline.

1. Open Internet Explorer, Mac Safari or Windows Chrome and log in to the unit.
2. Click **Management / License Management**.

The screenshot shows the 'License Management' interface with two tabs: 'Activate' and 'Transfer'. The 'Activate' tab is selected. Under 'Online Activation', there is an 'Input S/N' text box and an 'Activate' button. Under 'Offline Activation', there are three steps: 'Step 1: Export server information file' with an 'Export' button; 'Step 2: Copy exported offline.reg to a PC connected to the Internet, and use "OffLineTool.exe" to activate the license and get the offline license file'; and 'Step 3: Import offline license file' with an 'Import License File' text box, a 'Browse...' button, and an 'Import' button. At the bottom, there is a 'License List' section with a table header: S/N, Channel, Product, Status. Below the header, it says '*v There are no licenses yet.'

3. Input serial number under the section of **Online Activation**, and click the **Activate** button.
4. The license will be updated in License List if activated successfully.

The screenshot shows the 'License List' section with a table containing one row of data.

S/N	Channel	Product	Status
XXXX-XXXX-XXXX-XXXX	2	NVS	Activated

2.6.7 Offline License Activation

If the device is set up in Intranet (Local LAN) without Internet connection, there is another way to activate license.

1. Open Internet Explorer, Mac Safari or Windows Chrome and log in to the unit.
2. Click **Management / License Management**.

License Management

Activate **Transfer**

Online Activation

Input S/N

Activate

Offline Activation

Step 1: Export server information file

Export

Step 2: Copy exported offline.reg to a PC connected to the Internet, and use "OffLineTool.exe" to activate the license and get the offline license file

Step 3: Import offline license file

Import License File Browse...

Import

License List

S/N	Channel	Product	Status
There are no licenses yet.			

3. Click the **Export** button under the section of **Offline** Activation to export the information of this unit.
4. Download dialog pops up. Save the request file and take it to other PC which is connected to the Internet. Furthermore, the PC should be installed **OffLineTool.exe** which can be found from NVR toolkit.

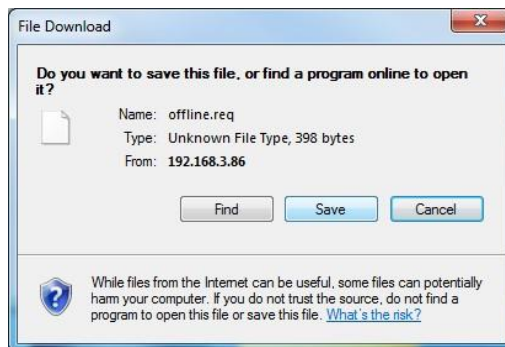

5. Execute the OffLineTool.exe in that PC with Internet connection, and select the request file **offline.req**.

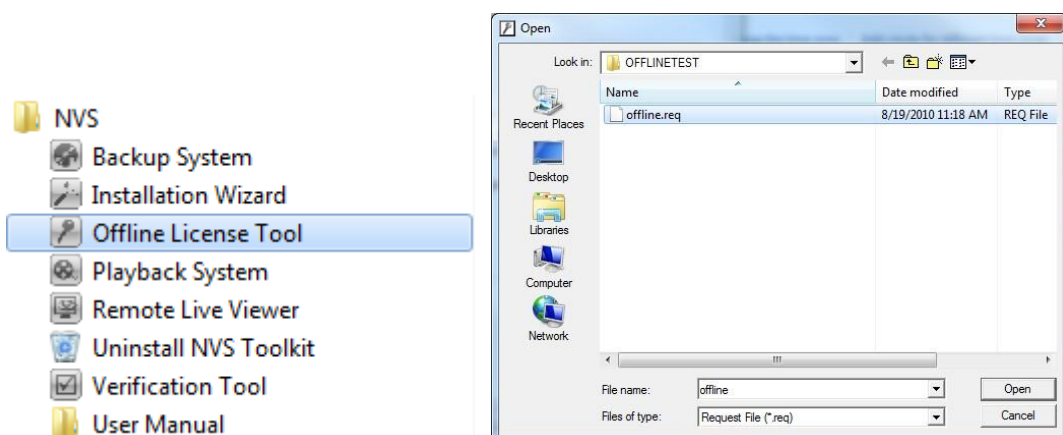

- Input the serial number, click the **Activate** button, and save the .dll file **offline_license.dll**.

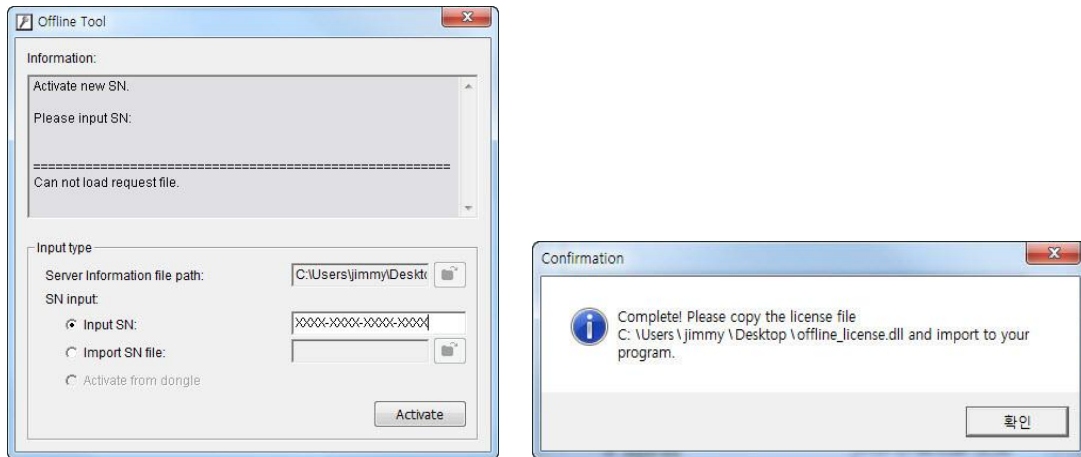

- Import the license file to the unit.

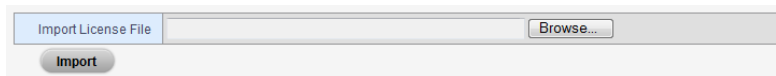

- The license will be updated in License List if activated successfully. System will reboot automatically.

S/N	Channel	Product	Status
XXXX-XXXX-XXXX-XXXX	2	NVS	Activated

2.6.8 Online License Transfer

There are two ways to transfer license, online and offline.

- Open Internet Explorer, Mac Safari or Windows Chrome and log in to the unit.
- Click **Management / License Management / Transfer**.

License Management

Activate Transfer

Online Transfer/Offline Export

Input S/N XXXX-XXXX-XXXX-XXXX

Online Transfer: Click the Transfer button to transfer license(s).

Transfer

Offline Export: Click the Export button to export the server information file, copy the exported offline.reg file to a PC connected to the Internet, and execute "OffLineTool.exe" to transfer license (s).

Export

License List

S/N	Channel	Product	Status
XXXX-XXXX-XXXX-XXXX	2	NVS	Activated

3. Select the license you want to transfer from the License List below, and click the **Transfer** button.
4. The license will be removed from License List if transferred successfully.

2.6.9 Offline License Transfer

If the device is set up in Intranet (Local LAN) without Internet connection, there is another way to transfer license.

1. Open Internet Explorer, Mac Safari or Windows Chrome and log in to the unit.
2. Click **Management / License Management / Transfer**.

License Management

Activate Transfer

Online Transfer/Offline Export

Input S/N XXXX-XXXX-XXXX-XXXX

Online Transfer: Click the Transfer button to transfer license(s).

Transfer

Offline Export: Click the Export button to export the server information file, copy the exported offline.reg file to a PC connected to the Internet, and execute "OffLineTool.exe" to transfer license (s).

Export

License List

S/N	Channel	Product	Status
XXXX-XXXX-XXXX-XXXX	2	NVS	Activated

3. Select the license you want to transfer from the License List below, and click the **Export** button.
4. Download dialog pops up. Save the request file. The license will be removed

- from License List temporarily, but the transfer process is not finished yet.
- Take it to other PC which is connected to the Internet. Furthermore, the PC should be installed **OffLineTool.exe** which can be found from NVR toolkit.
 - Execute the OffLineTool.exe in that PC with Internet connection, and select the request file **offline.req**.

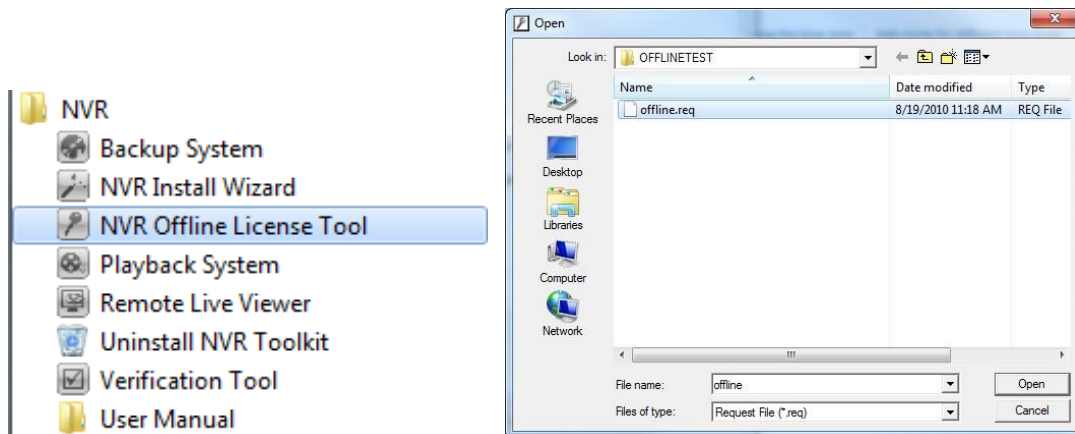

- The license you are going to transfer is listed. Click the **Transfer** button to finish the transfer process.

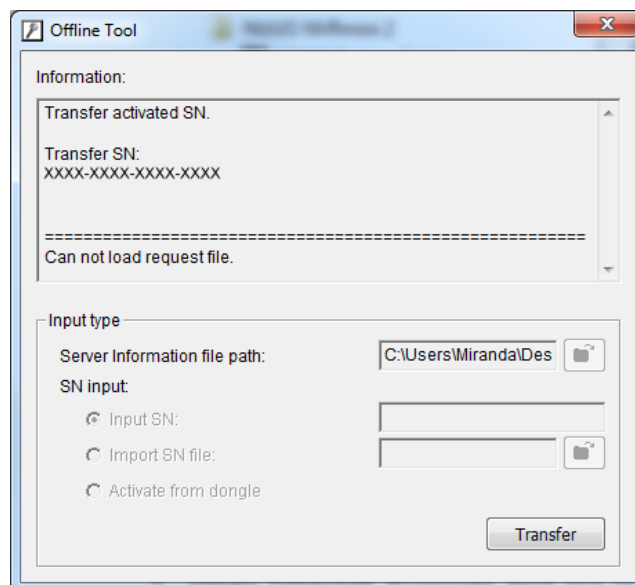

2.6.10 View the Event Log

- Open Internet Explorer, Mac Safari or Windows Chrome and log in to the unit.
- Click **Management / Log System** to find the event list of your unit.

Log System

System Log | **NVR Event Log** | Export and Backup Log

System Log

From: 2014/03/17 To: 2014/03/17 Type: All Query Export

<< < 1 > >> Show detailed playback access log

Date	Time	Type	Level	Log
2014-03-17	18:15:27	User Login	info	admin (10.0.2.37) is logging in to Settings
2014-03-17	18:08:04	User Login	info	(Localhost) is logging in to Live Streaming Service
2014-03-17	18:06:44	User Login	info	(Localhost) is logging in to Live Streaming Service
2014-03-17	18:06:10	Network	info	Start LAN eth0 with DHCP IP 10.0.2.19
2014-03-17	18:05:17	User Login	info	(Localhost) is logging in to Live Streaming Service
2014-03-17	17:48:54	Hardware	info	NVS System Started
2014-03-17	17:48:46	Hardware	info	NVR system starts
2014-03-17	17:48:46	RAID	info	VOLUME1 is ready
2014-03-17	17:48:45	Disk	info	Disk1 is found
2014-03-17	17:48:45	RAID	info	RAID info of Disk1: level 0, uuid 5c2b8946.d2306bdb.24e0d54a.0a28ef7b, 1 device (S)
2014-03-17	17:48:42	Hardware	info	Enable smart fan
2014-03-17	17:48:42	Hardware	info	NVR system stop

There are four kinds of event which will be listed on this page.

- **System Log**: The log information of the operations to your unit, such user access information, as reboot or shut down.
- **NVR Event Log**: The log information of the “Event & Action Management”, such as motion detection or camera connection lost.
- **Export and Backup Log**: The log information of the track of video data exported and backup.



The NVR Event Log will be recorded only if event is selected on **Event & Action Management** page. As for user access information, please go to **Network Service** to check **Log Access** box to enable this function.



You may click on  to view the event playback in a separated page at **NVR Event Log** page.

2.6.11 Save Unit Configuration

Save configuration can let you save the settings of this unit. These settings can be applied to other units, which will let you set other units more easily.

1. Open Internet Explorer, Mac Safari or Windows Chrome and log in to the unit.
2. Click **Management / Save / Load Configuration**.
3. Click the **Save Configuration** tab.

Save/Load Configuration

The screenshot shows the 'Save Configuration' tab of the 'Save/Load Configuration' dialog. It features a 'Save Configuration' radio button, a 'Save' button, and two optional checkboxes: 'E-Map Settings' and 'POS Settings'. The text below the radio button reads: 'Click the Save button to save the configuration of Camera Settings, Recording Settings, Event & Action Settings, E-Mail Settings and Server Settings.'

4. Check the box of **E-Map Settings** or **POS Settings** if you want to keep the configuration.
5. Click the **OK** button.
6. The configuration file will be generated into the chosen folder.



User account won't be exported as saving configuration, which implies the user list of push notification won't be saved as well.

2.6.12 Load Unit Configuration / Default Settings

Load configuration can let you apply another unit's settings to the current unit; Load Default Settings will revert all of the unit's settings back to the default factory settings.

1. Click **Management / Save / Load Configuration**.
2. Click the **Load Configuration** tab.

Save/Load Configuration

The screenshot shows the 'Load Configuration' tab of the 'Save/Load Configuration' dialog. It features a 'Load Default Settings' radio button, a 'Load' button, and a 'Network Settings' checkbox. Below this is a 'Load Configuration' section with a 'File Name' field, a 'Browse...' button, and two optional checkboxes: 'E-Map Settings' and 'POS Settings'. The text below the radio button reads: 'Click the Load button to load default factory settings. Uncheck the following box if you want to keep the network settings.'

3. Follow the direction to **Load Default Settings** or **Load Configuration**. For the former, uncheck the box of **Network Settings** to keep the IP address; for the latter, check the box of **E-Map Settings** or **POS Settings**

- if you want to restore the configuration.
- Click the **Load** button.
 - A confirmation dialog pops up. Click the **OK** button to begin to load the settings into your unit.



If there is POS database existed in the unit, loading configuration with different POS application config is likely to make the original POS data unsearchable.



If the saved configuration is without E-map or POS settings, selecting loading configuration with E-map/POS settings will lead you get the default. The original E-map/POS settings (if any) are covered and untraceable.



User account and privilege will be kept even if loading default settings, while camera settings, recording schedule, event & action settings, Email setting and server settings won't be. **RAID information** will always be kept whether loading default settings or loading configuration.

2.7 System

2.7.1 View System Information

- Open Internet Explorer, Mac Safari or Windows Chrome and log in to the unit.
- Click **System / System Information**.

System Information

System Information	
● Information	
Operating System	Linux
NVR Version	01.00.0104.0215
Device Pack Version	02.08.0000.0011
CPU	ARMv7 Processor rev 0 (v7l)
MAC Address 1	08:7D:21:00:A0:3C
MAC Address 2	08:7D:21:00:A0:3D
CPU Temperature	37.000 °C
System Fan Speed	3110 RPM
Locate	<input type="button" value="Locate"/>

The system information includes the following items.

- **Operating System**: Embedded Linux
- **NVR Version**: NVR system version
- **Device package version**: Camera package version
- **CPU**: CPU model number

- **CPU Loading**: The approx. CPU loading of this unit
- **MAC Address**: MAC address of this unit
- **CPU Temperature**
- **System Fan Speed**
- **Locate**: Click to trigger the buzzer to let you know where the unit is

2.7.2 Smart Fan Control

1. Open Internet Explorer, Mac Safari or Windows Chrome and log in to the unit.
2. Click **System / System Settings**.
3. Click the **Fan Control** tab.

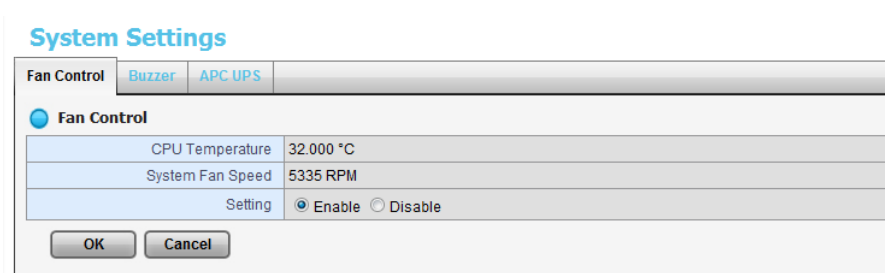

4. Check the **Enable** or **Disable** option.
5. Click the **OK** button.

2.7.3 Buzzer Configuration

There is a buzzer in the unit. When the unit finishes booting or when a problem is detected, this buzzer will sound. This buzzer is enabled by default. You can disable/enable this buzzer with the following steps. (We recommend that this buzzer should be enabled.)

1. Open Internet Explorer, Mac Safari or Windows Chrome and log in to the unit.
2. Click **System / Settings**.
3. Click the **Buzzer** tab.

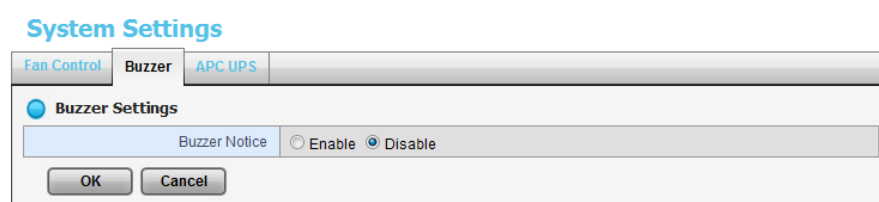

4. Check the **Enable** or **Disable** option.
5. Click the **OK** button.

2.7.4 UPS Setup

This feature enables you to tell your unit how long to run on APC Uninterruptable Power Supply (UPS) battery power and when to shut down, after power failure.

1. Attach the APC UPS to one of the unit's USB ports.
2. Open Internet Explorer, Mac Safari or Windows Chrome and log in to the unit.
3. Click **System / Settings**.
4. Click the **APU UPS** tab.
5. Check one of the options:

System Settings

Fan Control | Buzzer | **APC UPS**

Information

Manufacturer	APC
Product Name	Smart-UPS 3000 FW:655.18.D USB FW:7.4
Serial Number	JS0939022759
Service Status	ON

Power Failure Action

Disable
 System shutdown as power of the UPS remains ___ %
 System shutdown as power of the UPS remains ___ Min.

OK | Cancel

- **Disable**: Run until the UPS battery is depleted
- **System shutdown as power of the UPS remains ___ %**: Run until the UPS battery remains this percentage.
- **System shutdown as power of the UPS remains ___ min.**: Run until the UPS battery remains the certain period of time.

6. Fill in the specific value if you choose the last two options.
7. Click the **OK** button.

2.7.5 Upgrade the System

1. Open Internet Explorer, Mac Safari or Windows Chrome and log in to the

unit.

2. Click **System / Upgrade**.
3. Click the **Firmware Upgrade** tab.

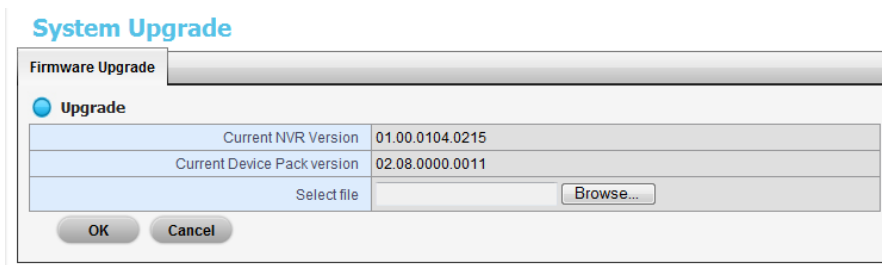

4. Browse the FW for upgrading and click the **OK** button.
5. A confirmation dialog pops up. Click the **OK** button to start upgrade process.
6. After upgrade, the system will restart. You need to re-access the unit again after this.



Please do not power off the server while system upgrading.



When upgrading firmware, please make sure the network is stable and the bandwidth is more than 2 Mbps.

2.7.6 System Date and Time Setup

1. Open Internet Explorer, Mac Safari or Windows Chrome and log in to the unit.
2. Click **System / Date/Time**.

Date/Time

Setup

Time Zone

Time Zone (GMT) Coordinated Universal Time, Greenwich Mean Time: Dublin, Lisbon, London

Date/Time List

Year 2012

Month 10

Day 5

Time 17 : 55 : 30

Daylight Saving Time

Daylight Saving Time Adjust the clock for daylight saving changes +2 hour(s)

Start Time March 25 1:00
 January First Sunday 1:00

End Time October 28 2:00
 January First Sunday 1:00

NTP Setup

Network Time Enable

Time Server pool.ntp.org (e.g. pool.ntp.org)

Update Time Interval Every week Saturday 23:00

Update Now

OK Cancel

3. Choose the time zone.
4. Configure the year, month, day and time manually, or enable NTP server to synchronize time automatically. When NTP server enabled, the date/time settings will be grayed out.
5. Check the **Adjust clock for daylight saving changes** option and select the time change of daylight saving time in your location. Choose the start time and end time of recurrence.
6. Click the **OK** button to restart system to activate the changes.



Clicking the **Update Now** button will save the settings automatically before restarting system.

2.7.7 Restart the Unit

1. Open Internet Explorer, Mac Safari or Windows Chrome and log in to the unit.
2. Click **System / Reboot/Shut down**.

Reboot/Shut down

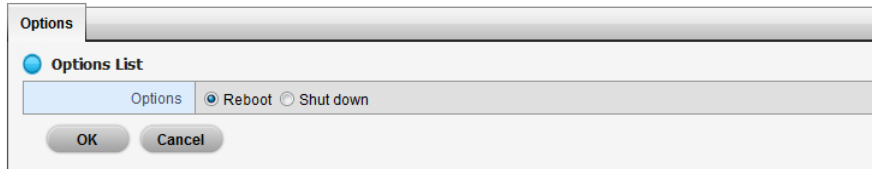

3. Check the **Reboot** option.
4. Click the **OK** button.
5. A confirmation dialog pops up. Click the **OK** button to reboot the unit.

The restart procedure runs automatically. When the unit is fully online:

- The System Status LED turns blue.
- The buzzer beeps one time (if the buzzer is enabled).



During system restart, none of your files will be accessible from your desktops/laptops.

2.7.8 Shut Down the Unit

The only time you need to shut down the unit is to replace the disk drive cooling fan or the power supply. During and after the shut \down, none of your files will be accessible from your desktops/laptops. There are two ways to shut down the unit.

- **Shut down by Software**

1. Open Internet Explorer, Mac Safari or Windows Chrome and log in to the unit.
2. Click **System / Reboot / Shut down**.

Reboot/Shut down

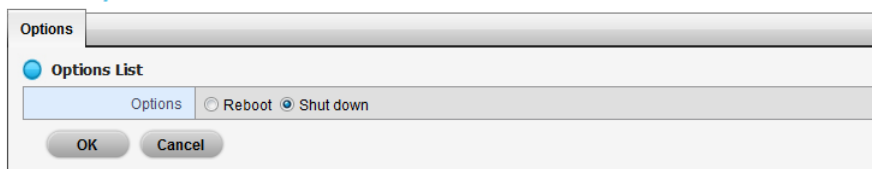

3. Check the **Shut down** option.
4. Click the **OK** button.
5. A confirmation dialog pops up. Click the **OK** button to shut down the unit.

- **Direct Shutdown**

1. Open the lid of the unit.
2. Press and hold the power button for 2 seconds and release your hands when the buzzer is beeping once.
3. System will begin the shutdown process, which takes about 30 seconds to few minutes depends on number of recording channels and other factors.



If the system is crashed and stocked, you can press the power button and hold it for 10 seconds to force to cut off the power directly. We don't recommend to do it if the system work properly.

3.POS

3.1 Introduction

3.1.1 System Introduction

POS, a Point of Sales Systems based on NVC provides financial transaction’s surveillance solution in one central system. The architecture is as below; POS transaction data flows to NVC by Ethernet. Each Cash Register with an external receipt printer is connected by DB9 cable. The transaction information delivered in R232 format can be converted to Ethernet through SCB-C31A POS data capture converter.

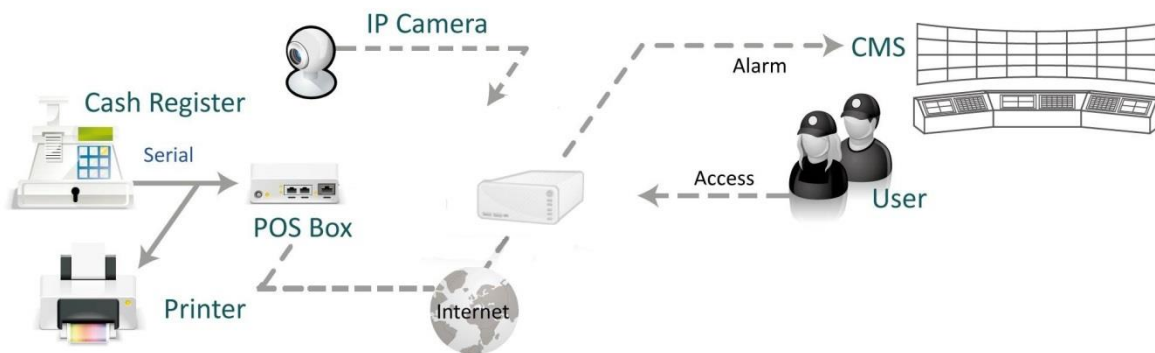

Definition of Terms

Terms	Definition
POS Original Data	Original data from POS. Usually with a lot of symbols and no line feed.
POS Transaction	Filtered result by user-defined tag-filter.

Product Specification

POS Box SCB-C31A	
Input	RS232
Output	Ethernet
DC In	DC +10V to +15V
Power consumption	500 mA
Operating Temperature	-20 to 65°C
Operating Humidity	0-90 % Non-Condensing

Baud Rate	110 bps to 230.4 kbps
Data Bits	5, 6, 7 or 8
Stop Bits	1, 1.5 or 2
Parity	None, Even, Odd, Mark, Space
Flow Control	None, RTX/CTS, XON/XOFF, DTR/DSR

3.1.2 Hardware Installation – SCB-C31A

To connect Cash Register, Printer, and SCB-C31A POS data capture converter together, please follow below steps:

Step 1: Please refer the user manual to setup Cash Register and printer.

Step 2: Using a “Y-shape” DB-9 cable, one DB-9 female connect to POS system and one DB-9 male connect to the receipt printer Y-shape (provided by Printer vendor).

Step 3: Using another DB-9 female connect to SCB-C31A POS Data Capture R232/Ethernet converter with Null modem.



There are two kinds of serial cable: Straight pass-through and Null-Modem. The connection between SCB-C31 POS Data capture box and Y-cable must be null modem (in package).

Step 4: Check the system switch of the SCB-C31A is switched to OFF-OFF position.

Step 5: Connect SCB-C31A with power source.

Step 6: Connect SCB-C31A with internet port by RJ45 LAN cable.

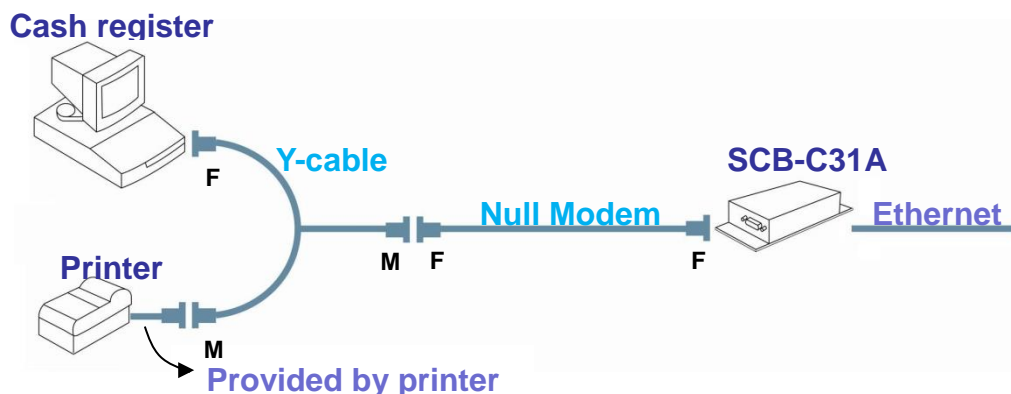

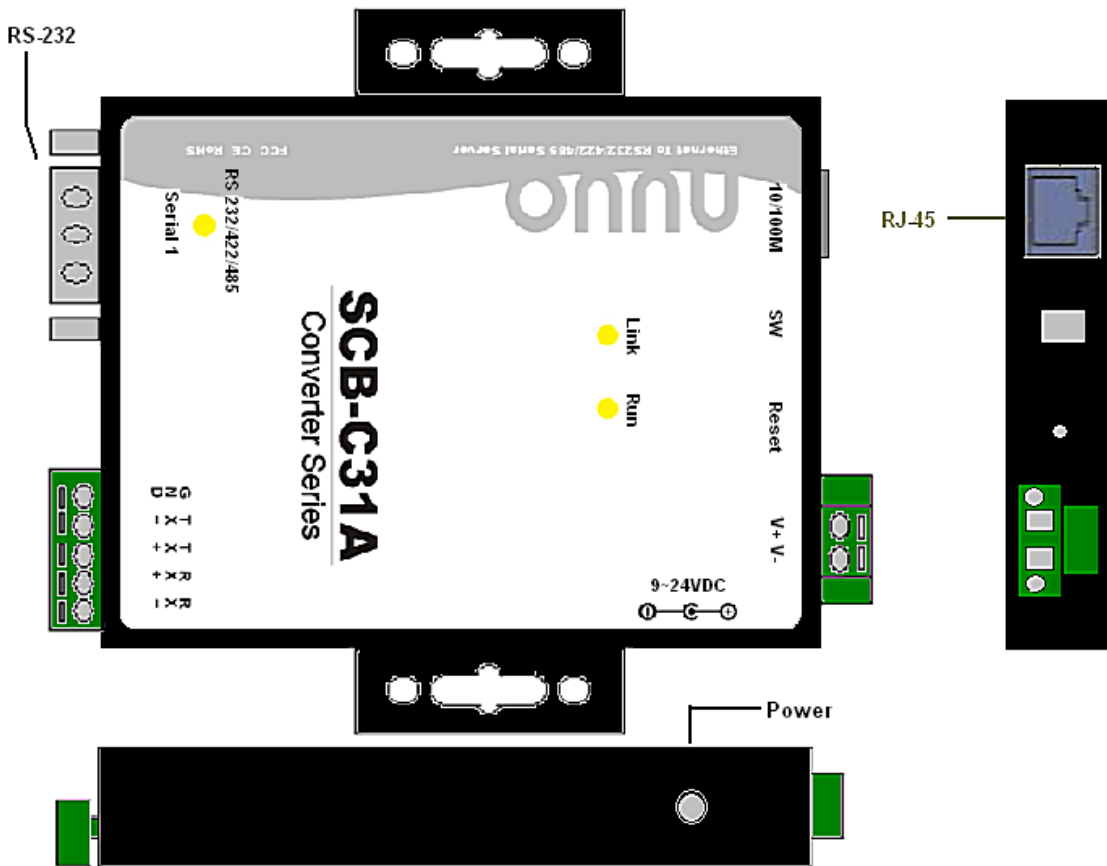

The LED Indicators:

LINK LED: Ethernet cable connection and data active.

RUN LED: System is ready (Blinking).

Serial 1: Transmitting/Receiving Indicator.

3.1.3 Software Installation – SCB-C31A

Step 1: Use IE-browser to setup SCB-C31A, the default IP address is **192.168.1.1**

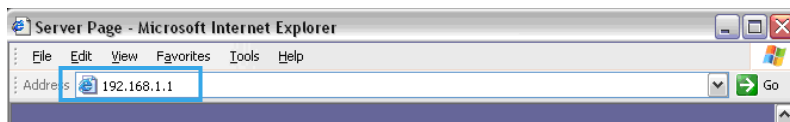

Step 2: Setup IP address and password in **Server** page, and click the **Save** button.



Each time you switch the page of the web, please click Save at first. If you leave this page without saving, all changes will be ignored.

Step 3: Setup Password if needed. Password is only using to activate a security feature on the serial server. Once a password is entered it will be required to access the menu and make change of configuration when access.



Please write down the Serial number and MAC address, these two parameters are necessary when user forget your password.

SCB-C31A Web Configuration - SCB-C31A

Note: If you leave this page without saving, all changes will be ignored!

Server	Server name:	SCB-C31A
Serial Port	Serial number:	00814
Operation	Version & Date:	1.8.30 & 090910
	Password:	
	DHCP:	Enable
	IP address:	192.168.1.29
	Netmask:	255.255.252.0
	Gateway:	192.168.1.1
	MAC address:	00:0B:B4:81:12:B8
	Link status:	100/Full Duplex
	Hardware ID:	PP-1001-A2

Save Default Running Reset

Step 4: Setup according to your POS or Cash Register. Usually all devices are default setting, you can reserve your time to pass this step.

Step 5: Please **restart/reset** the box after changing configurations to active setup.

To reset the unit manually apply power, insert a small plastic tool, and press lightly depressing reset located between the switch. Hold for 3 seconds and release. The Link and Run light will go out and turn back on. The SCB-C31A will revert to the last setting.



Every time you change the configuration of SCB-C31, please check above setting, especially maximum connection and Remote IP address to avoid connection fail.

3.1.4 Connection via TCP Client

If the cash register possess network, please install system according to following diagram and purchase a POS license to activate this function.

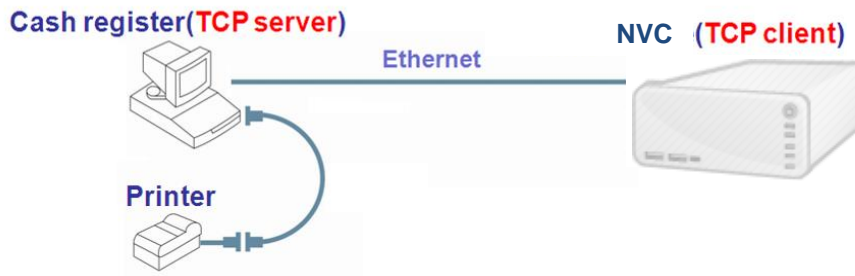

3.2 Software Setup

3.2.1 Activate POS License

If you are not the SCB-C31 user, you need to activate POS license before starting the following settings, please refer to **License Activation** for details.



3.2.2 NVR POS Setting

1. Open Internet Explorer, Mac Safari or Windows Chrome and log in to the unit.
2. Click **POS & I/O / POS Settings**.

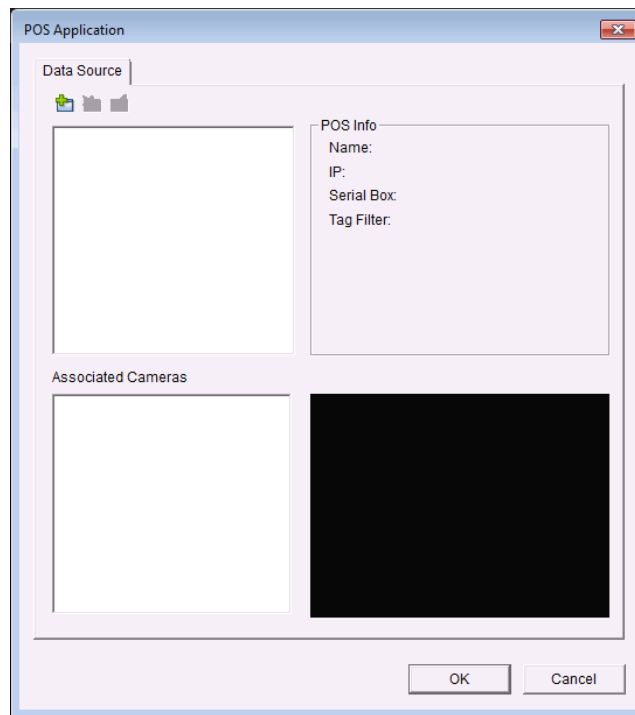

3. Click the **Settings** tab to set POS application.



- **Data Source:** List of all the data sources.
 -  **Insert:** Click to insert POS and do the POS settings. See **Insert POS Setting** for details.
 -  **Delete:** Click to remove the selected POS from the list. See **Delete POS Device** for details.
 -  **Configure:** Click to configure the selected POS and modify the POS settings. See **Configure POS Setting** for details.
- **POS info:** The setting information of the selected POS on this window.
 - **Name:** Name of the POS data source.
 - **IP:** IP of the POS data source.
 - **Serial Box:** The serial box data source used.
 - **Tag Filter:** Tag type to filter the data from POS. See **Tag Filter** for details.
- **Associated Cameras:** List of all the associated cameras of the selected POS.

4. Click the OK button to finalize the modification.

3.2.3 Insert POS Setting

1. Click  **Insert** button to open the **POS Setting** window.
2. Set up basic data source, including **Name, Model, IP address, and Port**. There are three types of models.

- **SCB-C31**: The device possesses one POS license, and should be equipped with the cash register not working as TCP server.
- **SCB-C31A**: The difference from SCB-C31 is not possessing one POS license, so user should activate POS license.
- **TCP Client**: Cash register possesses with network, so no need to have SCB-C31A as a converter. POS license is needed.

3. After setting, click **Test Connection** to test POS device connection.

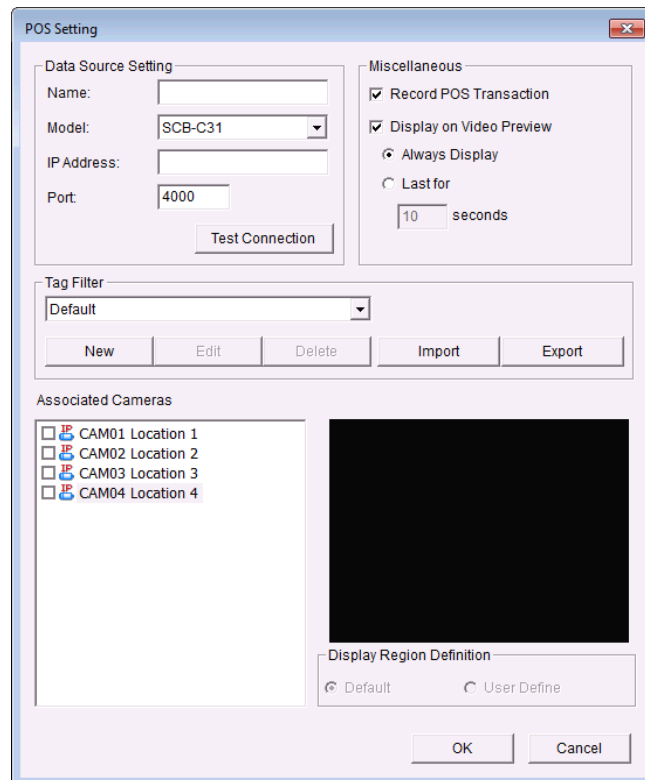

4. Set up Miscellaneous options, including **Record POS Transaction** and **Display on Video Preview**.

- **Record POS Transaction**: Select this checkbox to record POS transaction data. Users are allowed to search the POS data.
- **Display on Video Preview**: Select this checkbox to display POS transaction overlay on associated camera live video. Two types of transaction data display time:
 - **Name**: Name of the POS data source.
 - **Always**: Keep transaction data on video until receiving next transaction date.
 - **Last for ___ seconds**: Each transaction data only lasts on video for ___ seconds after receiving the last data of transaction.

5. Select **Tag Filter**. See **Tag Filter** for details.
6. Select the camera of **Associated Cameras** to display POS transaction data overlay on live video.
7. Set up display area for each camera video in **Display Region Definition**.
 - **Default**: The default display area is in the upper left corner of video image.
 - **User Define**: Enable **User Define**, and define display area by dragging rectangle
8. Click the **OK** button to save.

3.2.4 Delete POS Device

1. Choose POS device.
2. Click  **Delete** button to remove this POS device from the system.



3.2.5 Configure POS Setting

1. Choose POS device.
2. Click  **Configure** button to open the POS Setting window.
3. Refer to **Insert POS Setting** to modify configuration.

3.3 Tag Filter

The original transaction data from POS system is hard to read. Users can define filters to make the POS strings meaningful. The system also provides a simple default tag filter to filter out same common EPSON commands, users can base on this default tag filter to edit their customized filters.

3.3.1 Add New Tag Filter

1. Click  **Insert** button or choose a device and click  **Configure** button to open the **POS Setting** window.
2. Click **New** to open tag filter window.
 - **General**: Name of Tag Filter and Connect button.
 - **Original Data**: Original transaction data from POS device.
 - **Filtered Data**: Filtered data after definition.
 - **Filter Function**: Tool used for defining filter type.
 - **Filter List**: List of all filters.
 - **Data Tool**: Clear/import/export buttons to clear/import/export the

original and filtered data.

- **Filter Tool:** Upper/down buttons to arrange the priority of each filter; remove button to remove the filter from list.

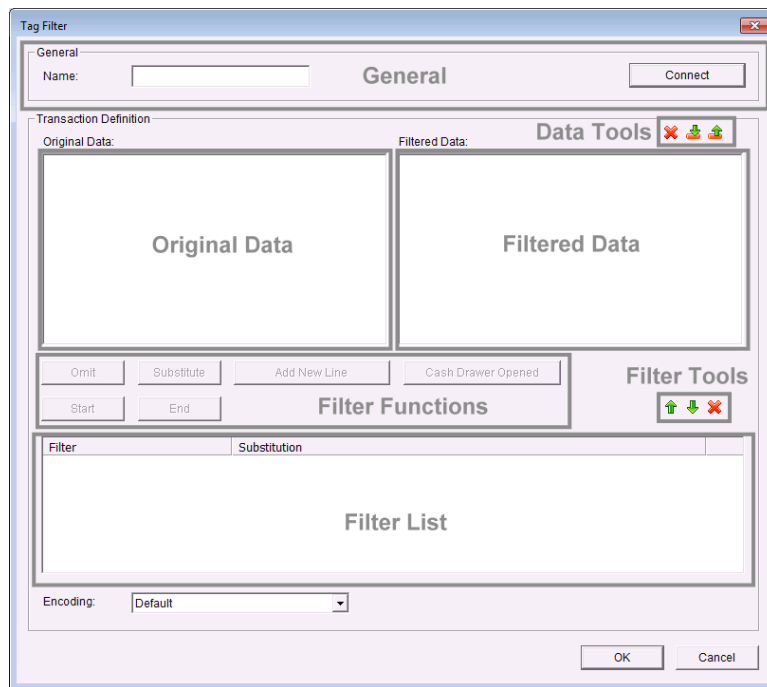

3. Enter name of this tag filter.
4. Click **Connect** button to capture POS transaction data from POS device. The original transaction data will be shown on the left window.



If you don't want the data keep importing when editing filter, click **Disconnect** button to stop connecting.

5. Data Tools

- **Clear:** Remove data from Original Data window and Filtered Data window.
- **Import:** Reload exported binary data.
- **Export:** Capture and export original binary data.

6. Start to edit tag filters. Click and drag to select text from Original Data window, and then use the below six buttons to define filters. The filtered transaction data will be shown on the right window.

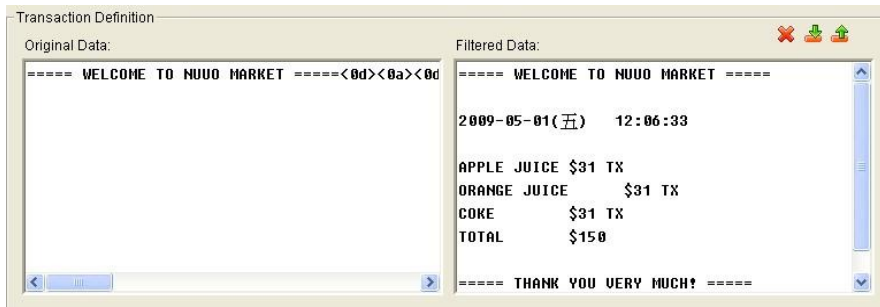

- **Omit:** Neglect the selected text which is meaningless or not important. The text will disappear on the right window.



- **Substitute:** Use another word(s) to replace the selected text. The system will pop up a substitution panel for replacing word(s) users want. The replaced text will be shown on the right window.



- **Add New Line:** Define the selected text as the symbol for changing to new line. The result will be shown on the right window.

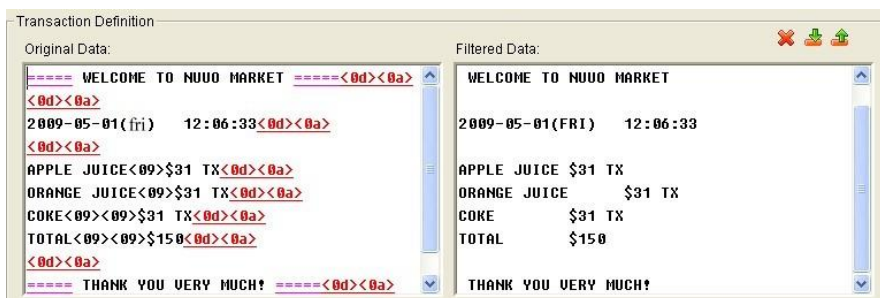

- **Start:** Define the selected text as the symbol for transaction beginning. The filtered data will be separated line as below.



- **Cash Register Opened:** Define the selected text as the symbol for opening cash register. The filtered data will be shown the **<Cash Drawer Open>** mark as below.

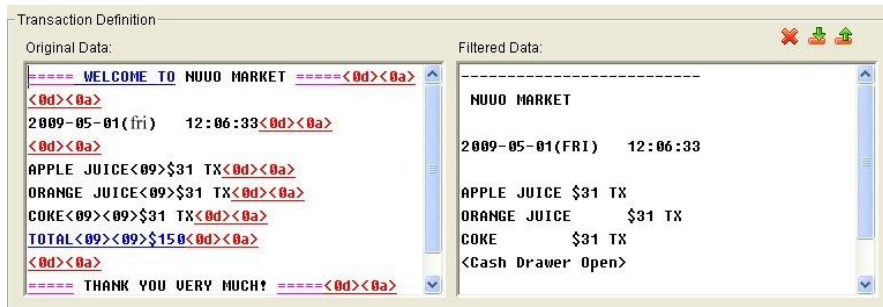

- **End**: Define the selected text as the symbol for transaction ending. The filtered data will be separated line as below.

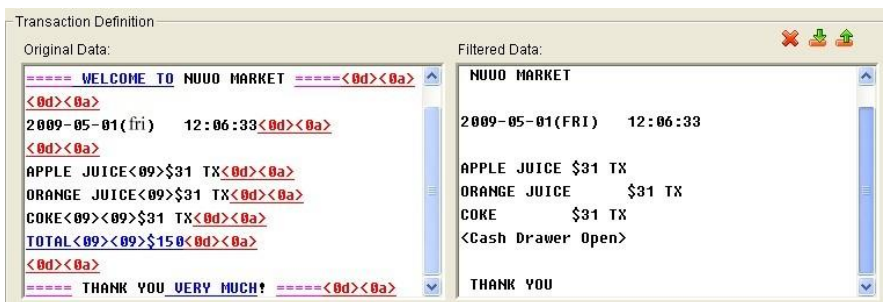

7. Filter Tools

- **Up**: Move a tag filter up; the upper filter will be operated earlier.
- **Down**: Move a tag filter down; the lower filter will be operated later.
- **Delete**: Remove a filter from this tag filter list.

Filter	Substitution
=====	
fri	FRI
<0d><0a>	<New Line>
WELCOME TO	<Transaction Start>
TOTAL<09><09>\$150	<Cash Drawer Open>
VERY MUCH	<Transaction End>

8. Click the **OK** button to save.

3.3.2 Edit Tag Filter

1. Select Tag Filter name from drop-down menu.
2. Click **Edit** button.
3. Configure the Tag Filter window.
4. Click the **OK** button to save.

3.3.3 Delete Tag Filter

1. Select Tag Filter name from drop-down menu.

2. Click **Delete** button to delete it.

3.3.4 Import/Export Tag Filter

1. Click **Import/Export** button and select Import/Export URL.
2. Click **Open/Save** to Import/Export Tag Filter.
3. After importing tag filters, users can simply select tag filter from drop-down menu without editing new tag filter.

3.4 POS Display Font

The system allows users to set up the fonts of POS transaction data on live view video and playback video.

3.4.1 Live View

1. Open Internet Explorer, Mac Safari or Windows Chrome and log in to the unit.
2. Click the **Live View**.
3. Click the **General Setting** button to open **Live View Setting** window.

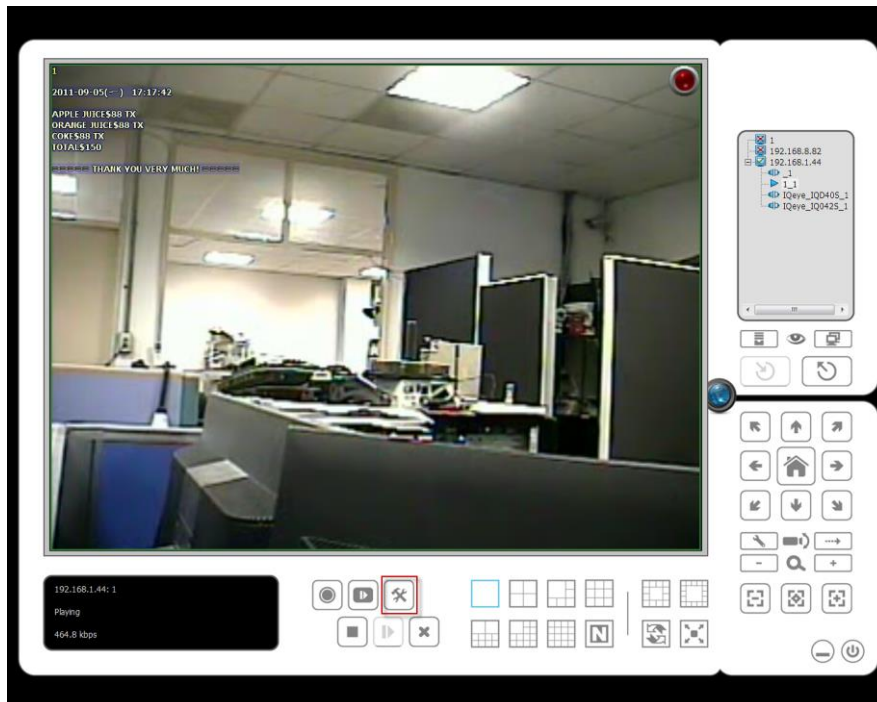

4. Select the font, font size, font color and background for the POS transaction data overlaid the video.

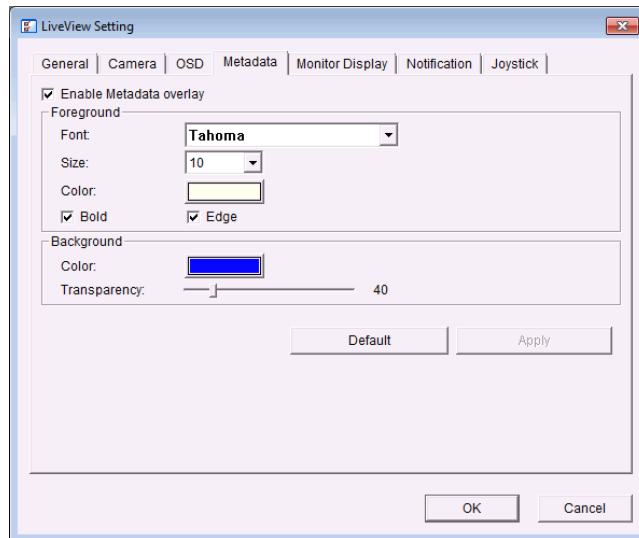

5. Click the **OK** button to save.

3.4.2 Remote Live Viewer

1. Startup > NVC > Remote Live Viewer
2. Click the **General Setting** button to open **Live View Setting** window.

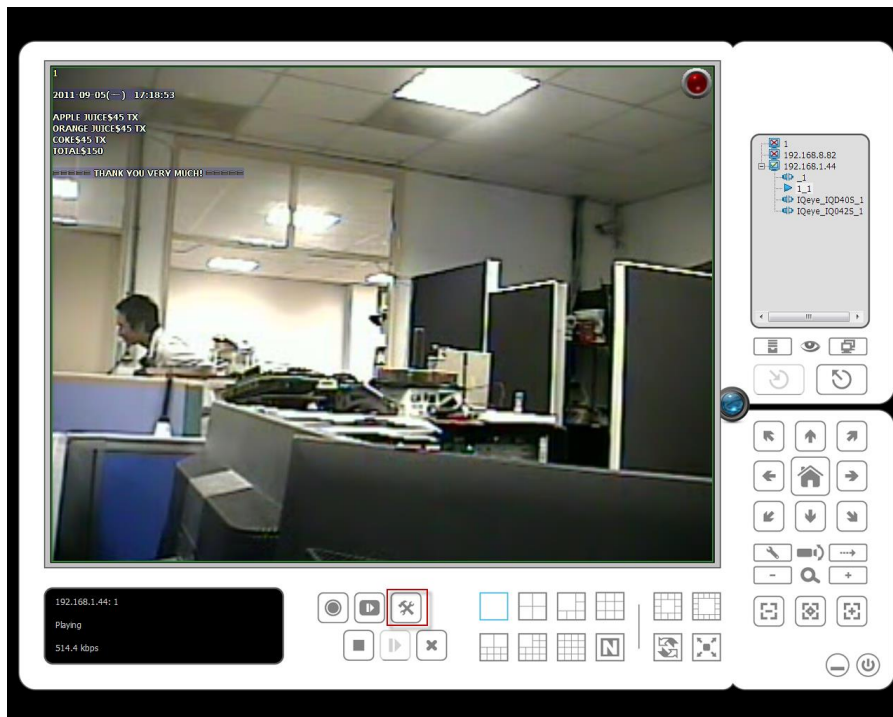

3. Select the font, font size, font color and background for the POS transaction data overlaid the video.

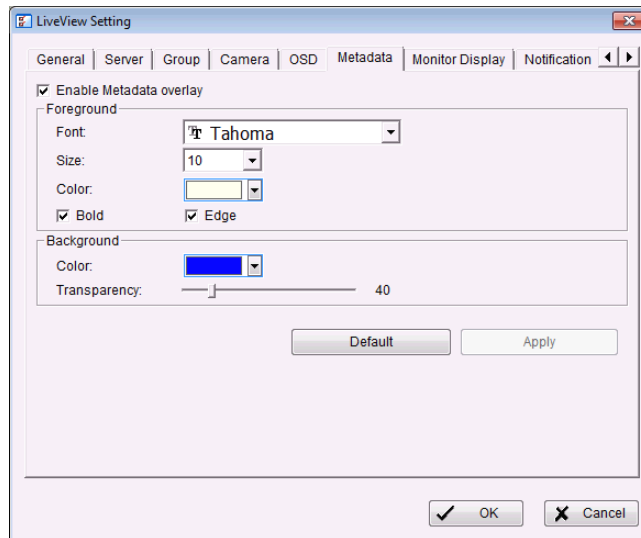

4. Click the **OK** button to save.

3.4.3 Playback

1. Open Internet Explorer, Mac Safari or Windows Chrome and log in to the unit.
2. Click the **Playback** button.
3. Click the **Setting** button to open **Setting** window.

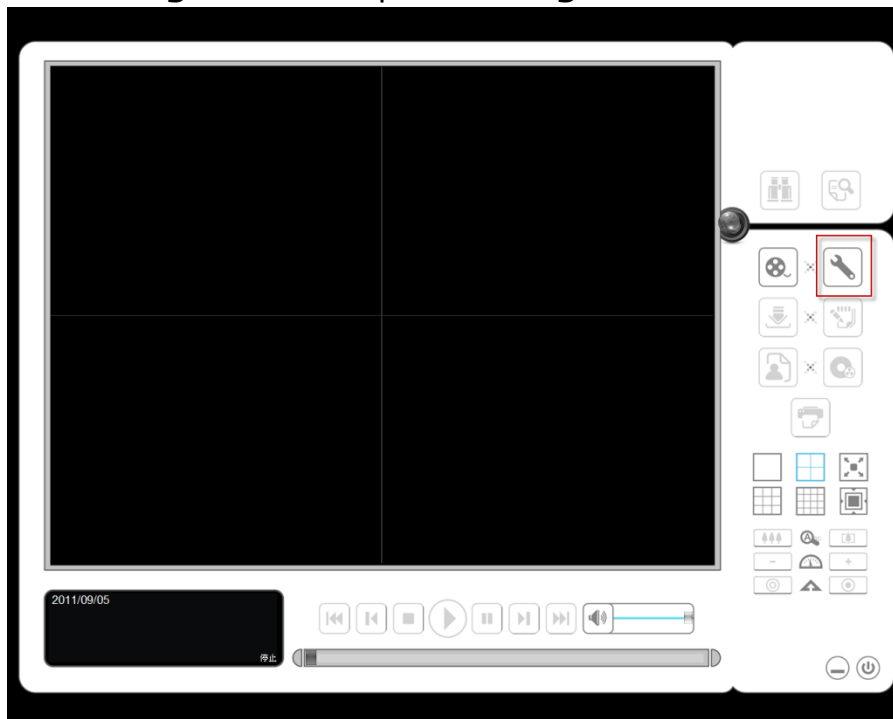

4. Select the font, font size, font color and background for the POS transaction data overlaid the video. Also, select the type of transaction data display time.

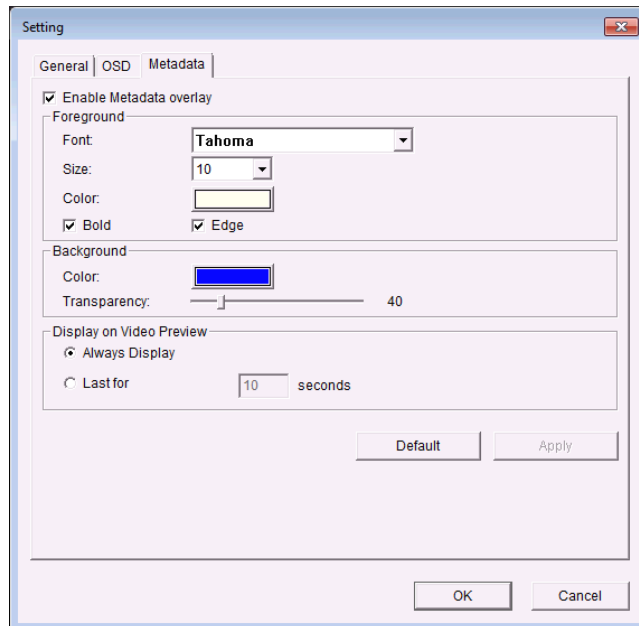

3.4.4 Playback System

1. Startup > NVC > Playback System
2. Click the **Setting** button to open **Setting** window.

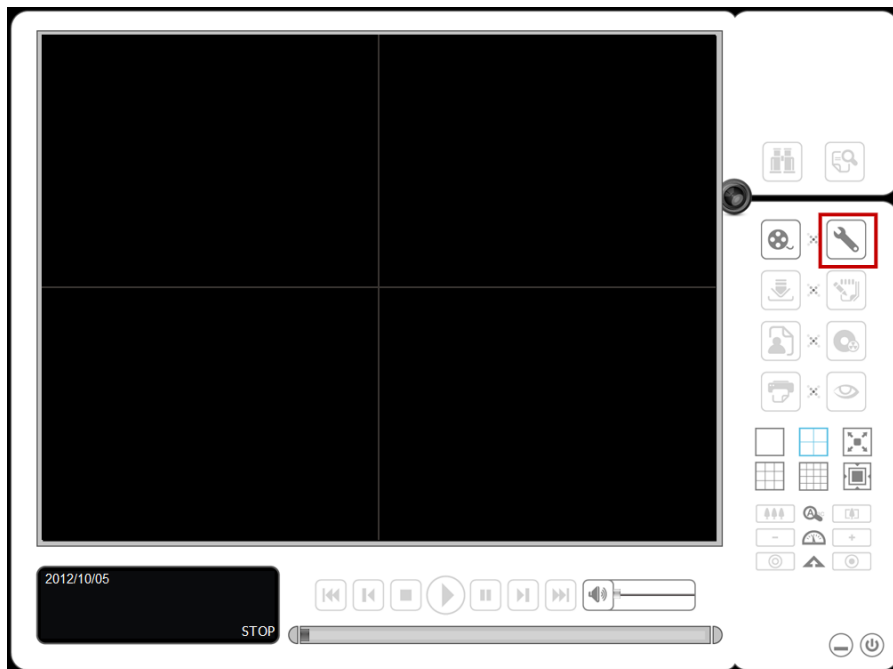

3. Select the font, font size, font color and background for the POS transaction data overlaid the video. Also, select the type of transaction data display time.

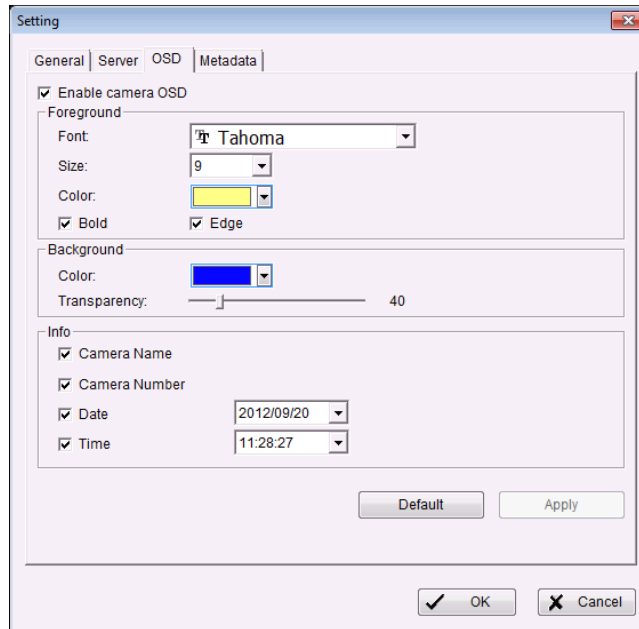



3.5 POS Transaction Data Search

POS Search tool is used to search key word of all transaction data.

3.5.1 Search POS Transaction Data through Playback

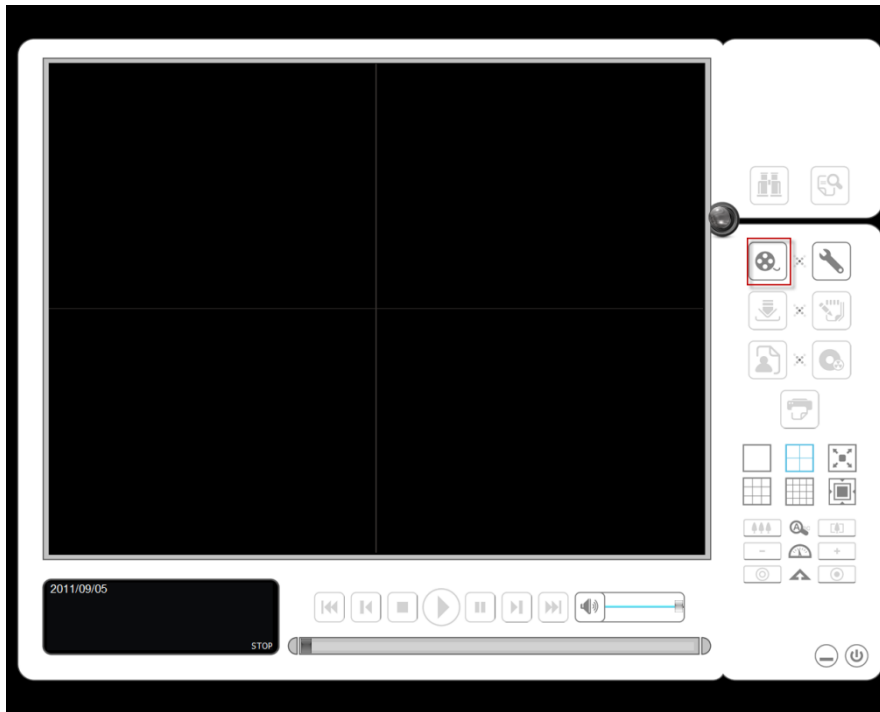
1. Open Internet Explorer, Mac Safari or Windows Chrome and log in to the unit.
2. Click the **Playback** button.
3. Click the **Open Record** button to open **Data Time Search Dialog** window.



4. Click the **POS Search** button  to open **POS Search Dialog** window.

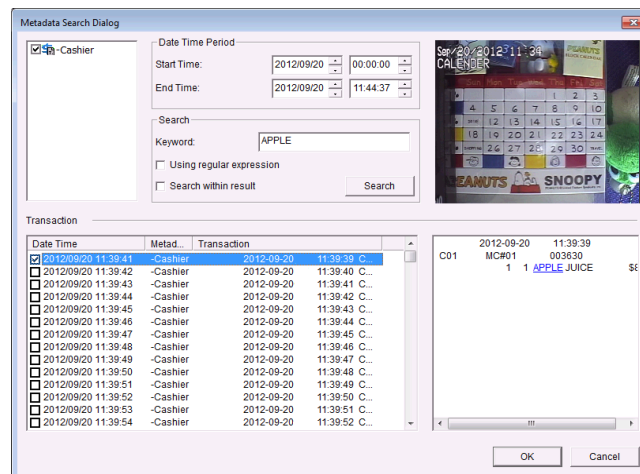

5. Select a POS device(s) from the POS list.
6. Set up Start Time and End Time in **Data Time Period** section.
7. Enter the keyword you want to search.
8. Click the **Search** button, the results will be shown in Transaction table.
9. Select an item from Transaction table, the transaction detail will be shown in the table of lower right corner, and the recorded video of associated camera will be shown in the upper right corner.
10. Select the checkbox of **Search within result**, and enter a keyword, you can search the data within the results.

3.5.2 Search POS Transaction Data through Playback System

1. Startup > NVC > Playback System.
2. Click the **Open Record** button to open **Data Time Search Dialog** window.
3. Click the **Remote Server Site**  icon on the top of the window to select the server users want to access.
4. Follow the step 4 through 10 of **Search POS Transaction Data by Playback** to search the data.

3.6 Playback Video with POS Data

Enable POS overlay in **Setting** window to view recorded video with POS transaction data (Refer to **POS Display Font**). If the option is enabled, the system will auto display transaction data when playing recorded video. There are two modes to select video period.

3.6.1 Select Period by POS Search

1. Refer to **POS Transaction Data Search**.
2. Select the transaction data from the result list, and click **OK**.

Date Time	Metad...	Transaction
<input checked="" type="checkbox"/> 2012/09/20 11:39:41	-Cashier	2012-09-20 11:39:39 C...
<input type="checkbox"/> 2012/09/20 11:39:42	-Cashier	2012-09-20 11:39:40 C...
<input type="checkbox"/> 2012/09/20 11:39:43	-Cashier	2012-09-20 11:39:41 C...
<input type="checkbox"/> 2012/09/20 11:39:44	-Cashier	2012-09-20 11:39:42 C...
<input type="checkbox"/> 2012/09/20 11:39:45	-Cashier	2012-09-20 11:39:43 C...
<input type="checkbox"/> 2012/09/20 11:39:46	-Cashier	2012-09-20 11:39:44 C...
<input type="checkbox"/> 2012/09/20 11:39:47	-Cashier	2012-09-20 11:39:45 C...
<input type="checkbox"/> 2012/09/20 11:39:48	-Cashier	2012-09-20 11:39:46 C...
<input type="checkbox"/> 2012/09/20 11:39:49	-Cashier	2012-09-20 11:39:47 C...
<input type="checkbox"/> 2012/09/20 11:39:50	-Cashier	2012-09-20 11:39:48 C...
<input type="checkbox"/> 2012/09/20 11:39:51	-Cashier	2012-09-20 11:39:49 C...
<input type="checkbox"/> 2012/09/20 11:39:52	-Cashier	2012-09-20 11:39:50 C...
<input type="checkbox"/> 2012/09/20 11:39:53	-Cashier	2012-09-20 11:39:51 C...
<input type="checkbox"/> 2012/09/20 11:39:54	-Cashier	2012-09-20 11:39:52 C...

3. The period you select from POS search results will be selected automatically.

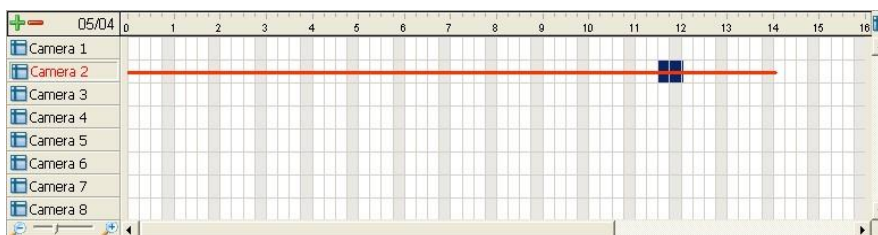

4. Click **OK** to playback videos.

3.6.2 Select Period by Data & Time through Playback

1. Open Internet Explorer, Mac Safari or Windows Chrome and log in to the unit.
2. Click the **Playback** button.
3. Click the **Open Record** button to open **Data Time Search Dialog** window.
4. Highlight the video clip you want to review by left-clicking and dragging the time period. You may also utilize the Start Time and End Time in **Date Time Period** section after choosing cameras.
5. Click **OK** to playback videos.

3.6.3 Select Period by Data & Time through Playback System

1. Startup > NVC > Playback System.
2. Click the **Open Record** button to open **Data Time Search Dialog** window.
3. Click the **Remote Server Site**  icon on the top of the window to select the server users want to access.
4. Highlight the video clip you want to review by left-clicking and dragging the time period. You may also utilize the Start Time and End Time in **Date Time Period** section after choosing cameras.
5. Click **OK** to playback videos.

3.7 Backup Video with POS Data

There are three ways to backup video with POS transaction data.

3.7.1 Backup through Internet Explorer

1. Open Internet Explorer and log in to the unit.
2. Click the **Open Record** button to select data.
3. Click the **Backup** button.

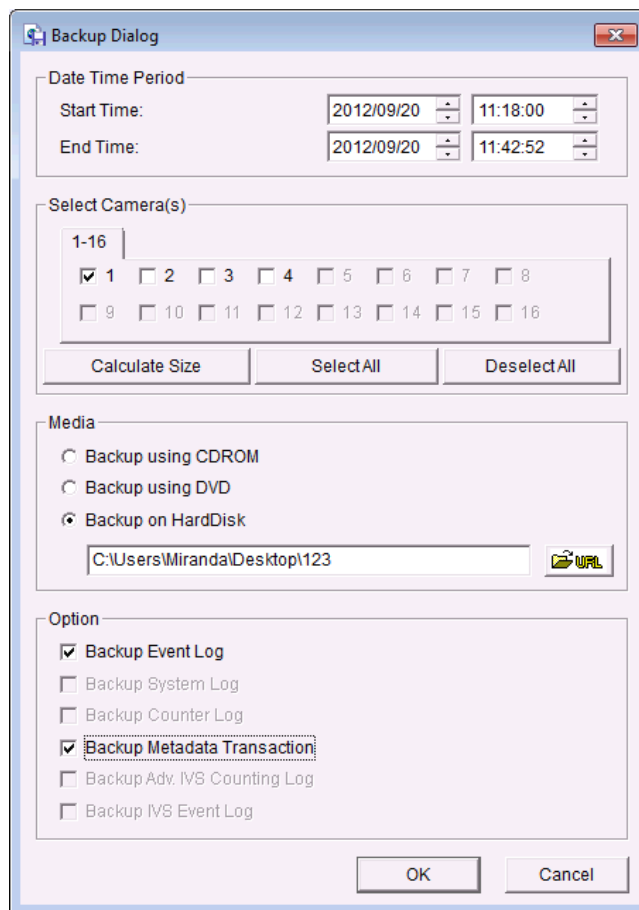

4. Check the **Backup POS Transaction** option.
5. Set the Start Time and End Time you want to backup.
6. Select the cameras you want to backup.
7. Select the directory you want to save the backup data.
8. Click the **Backup** button.
9. The system will then begin backup process automatically.

3.7.2 Backup through Playback System

1. Startup > NVC > Playback System.
2. Click the **Open Record** button to select data.
3. Click the **Backup** button.
4. Check the **Backup POS Transaction** option.
5. Set the Start Time and End Time you want to backup.
6. Select the cameras you want to backup.
7. Select the directory you want to save the backup data.
8. Click the **Backup** button.

3.7.3 Backup through Backup System

Please refer to step 1 to 14 of the content of **Backup and Delete Records**, and check the **Backup POS Transaction** option.

4.I/O

4.1 Introduction

4.1.1 System Introduction

We provide remote I/O solution for NVR by connecting SCB-C31 with I/O Box SCB-C24/26/28. Refer to the below architecture, I/O device is connected directly with I/O Box, and input/output signal delivered in RS485 format are converted to Ethernet through SCB-C31. NVR can use the signals to do more sophisticated setup, such as starting recording when input triggered, triggering output as an event happened, and much more.

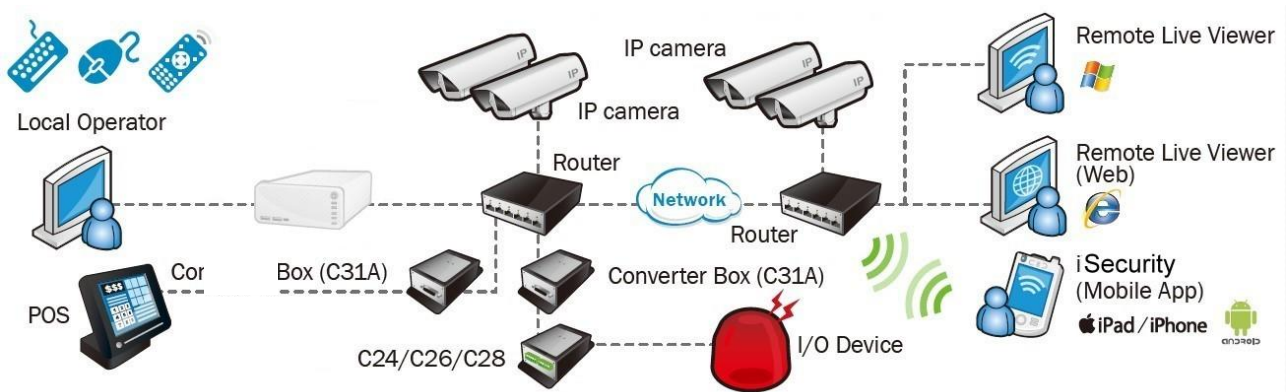

4.1.2 HW Installation

SCB-C24/26/28 must work with SCB-C31 (Ethernet-RS485 converter). Further, **the C31 Box cannot be used for POS and converter at the same time, and one C31 Box can be paired with one NVR unit only.** Please follow the steps below to configure the devices.

- Step 1: Check the system switch of SCB-C31 is switched to OFF-OFF position.
- Step 2: Connect SCB-C31 with power source.
- Step 3: Connect SCB-C31 with internet by RJ45 LAN cable.
- Step 4: Connect I/O Box with power source.
- Step 5: Connect SCB-C31 and I/O Box with cable, positive connection (TX+/D+ and DATA+) and negative connection (TX-/D- and DATA-). Take SCB-C31 with I/O Box SCB-C24 for example as below.

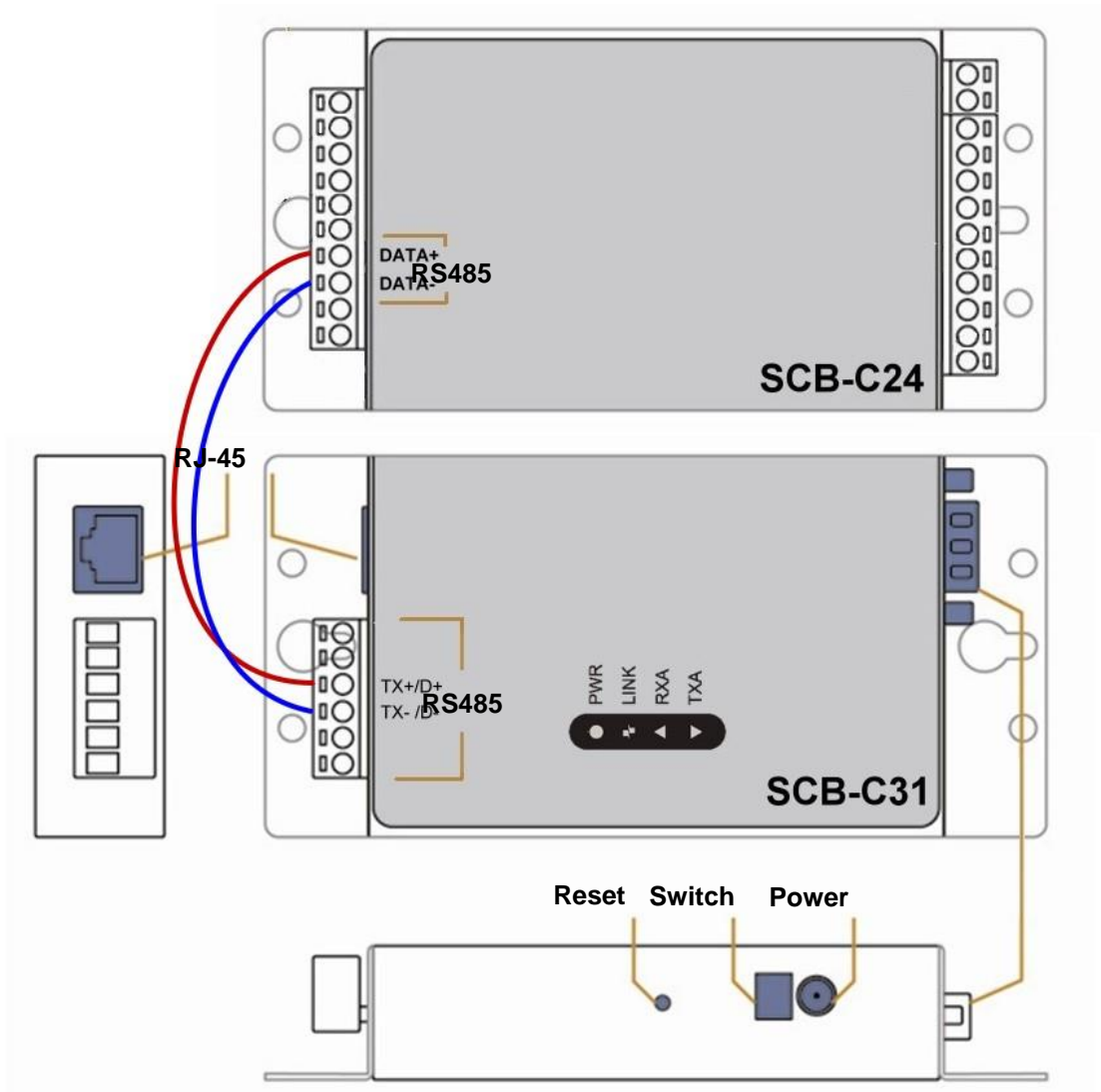

 **Multiple I/O Boxes can be connected to a single SCB-C31. However, series connection of I/O boxes is forbidden.** Furthermore, the default ID for each I/O Box is the same. Please follow the direction to setup I/O Box one by one.

4.1.3 Software Installation – SCB-C31

Step 1: Open Internet Explorer to setup SCB-C31. The default IP address is 192.168.1.1.

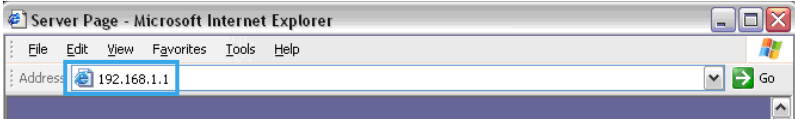

Step 2: Setup IP address and port.

1. Static IP Address

2. **Server Listening Port:** The default port is 4000, which is not the port for setting page, but for signal transmission.

Serial Settings	
Data Baud Rate	9600
Data Bits	8
Data Parity	None
Stop Bits	1
Flow Control	None
Network Settings	
	<input checked="" type="checkbox"/> Enable DHCP
Static IP Address	192.168.1.1
Static Subnet Mask	255.255.255.0
Static Default Gateway	192.168.1.3
Static DNS Server	168.95.1.1
Connection Type	TCP
Transmit Timer	30
Server/Client	Server
Server:	
Server Listening Port	4000
Client:	
Destination IP	192.168.1.2
Destination Port	4000
	<input type="checkbox"/> Enable Reboot
	<input type="button" value="Apply"/> <input type="button" value="Reset"/>
	<input type="button" value="Firmware Upgrade"/>

Step 3: Click the **Apply** button to activate configuration.



Due to the stability of data transmission, one SCB-C31 can be paired with one NVR unit only.

4.1.4 Software Installation – SCB-C24/26/28

The default ID of I/O Box is identical. To avoid the conflict between Boxes, please connect only one Box with SCB-C31 and execute the setup application to change the ID from the default value (1).

1. Execute IOConfig.exe, type in the IP address and port of SCB-C31, and click the **Scan** button.

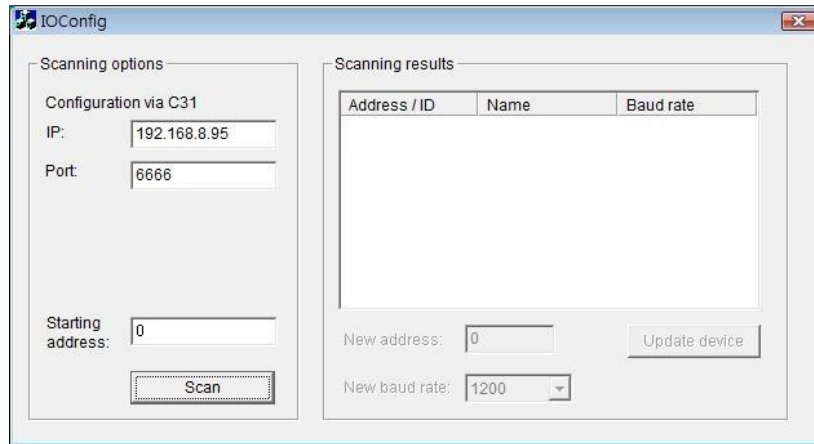

IOConfig.exe starts scanning the ID from 0 to 255, and it may take around a minute to finish scan.

- When the I/O Box is discovered, click on the item and change the ID from the **New Address** field. Click the **Update device** button to activate the settings.

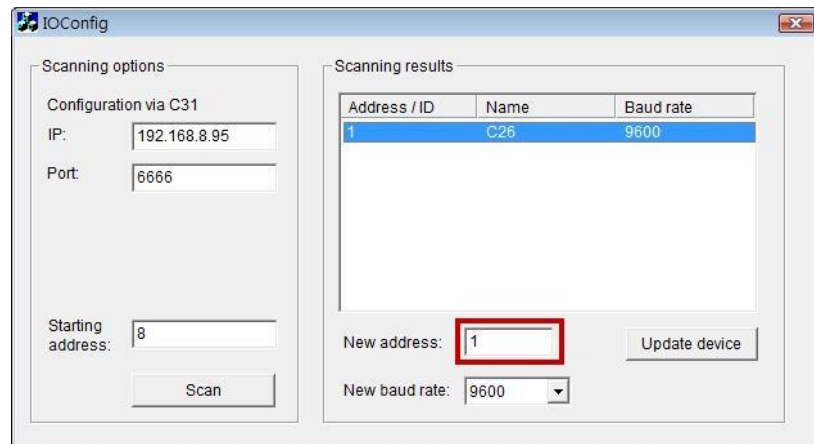

- Scan again to make sure the configuration is validated. In this case, we changed the ID to 10, so we can modify the number of "Starting address" to 10 to save the searching time.

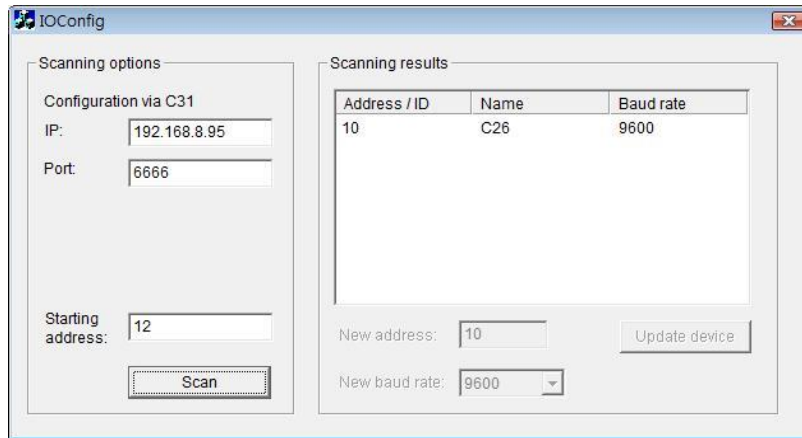

4. Refer to the **HW Installation** section to connect other I/O Box and repeat the steps 1 through 3 above to configure more I/O Boxes.

4.2 Software Setup

4.2.1 Add I/O Box

1. Open Internet Explorer, Mac Safari or Windows Chrome and log in to the unit.
2. Click **POS & I/O / I/O Settings / I/O Box Settings**.
3. Enter the information of I/O box.

I/O Settings

I/O Box Settings | I/O Pin Settings

I/O Box Settings

Device No.		
Device Name	<input type="text"/>	
Device Type	SCB-C31 + SCB-C24 ▾	
IP Address	<input type="text"/>	Port <input type="text"/>
ID	Addr:000 ▾	

I/O Box List

No.	Name	Type	IP Address	Port	ID	Delete
1	C Block	SCB-C28	192.168.8.2	4000	Addr:000	<input type="button" value="Delete"/>

- **Device No:** The unique ID system distributes in sequence automatically.
- **Device Name:** The name of the I/O box.
- **Device Type:** The types of I/O box, including SCB-C24, SCB-C26, and SCB-C28.
- **IP Address:** The IP Address of SCB-C31.

- **Port:** The transmission port of SCB-C31.
- **ID:** The ID of the I/O box.

4. Click the **Create** button, and the information will be updated in I/O Box List.
5. Repeat steps 3 and 4 to add more I/O boxes in the list.
6. Click the **Save** button to activate the settings. Meanwhile, system will distribute an unique ID to each device.

4.2.2 Modify I/O Box Information

1. Open Internet Explorer, Mac Safari or Windows Chrome and log in to the unit.
2. Click **POS & I/O / I/O Settings / I/O Box Settings**.
3. Click the I/O box which you want to modify from the list.
4. Modify the information of this I/O box, and click the **Modify** button.
5. Click the **Save** button to activate the settings.

4.2.3 I/O Pin Setting

1. Open Internet Explorer, Mac Safari or Windows Chrome and log in to the unit.
2. Click **POS & I/O / I/O Settings / I/O Pin Settings**.
3. All input and output pins are shown in this page, including the ones from cameras and I/O boxes. Check the box to enable a pin (defaulted), and type a name in the field for each I/O pin.

I/O Settings

I/O Box Settings | **I/O Pin Settings**

I/O Pin Settings

Device Name		I/O Pin	Name	Output Duration	Associated Camera
Location 1	<input checked="" type="checkbox"/>	Input #0	<input type="text"/>		Location 1 ▾
	<input checked="" type="checkbox"/>	Output #0	<input type="text"/>	N/A ▾	
I/O BOX 51001(C Block)	<input checked="" type="checkbox"/>	Input #0	Gate <input type="text"/>		Location 1 ▾
	<input checked="" type="checkbox"/>	Input #1	Lobby <input type="text"/>		N/A ▾
	<input checked="" type="checkbox"/>	Input #2	Ground <input type="text"/>		N/A ▾
	<input checked="" type="checkbox"/>	Input #3	<input type="text"/>		N/A ▾
	<input checked="" type="checkbox"/>	Output #0	<input type="text"/>	10 sec. ▾	
	<input checked="" type="checkbox"/>	Output #1	<input type="text"/>	N/A ▾	
	<input checked="" type="checkbox"/>	Output #2	<input type="text"/>	N/A ▾	
<input checked="" type="checkbox"/>	Output #3	<input type="text"/>	N/A ▾		

Save **Reset**

4. For input pin, you can select an associated camera for it, which will be the communication media for server and client. (e.g. when an input was triggered and pushed a notification to mobile, users can playback the videos of its associated camera.)
5. For output pin, you can configure its duration time to control how long output acts after it's triggered. The duration range is 3 sec~60 sec. N/A stands for no duration time pre-defined, output stops acting when the event stops.
6. Click the **Save** button.



If the box of I/O pin is unchecked, this pin won't be shown on relative application pages. In other words, you cannot do any setting/operation with this pin. See details in next section.

4.3 Relative Configuration and Application

4.3.1 Record on Input Trigger

Refer to **Recording Schedule / Event Setup**.

4.3.2 Input and Responding Actions

Refer to **I/O Box Input and Responding Action Setup**.

4.3.3 I/O Control Panel in Live View

Refer to **Live View Control Panel**.



5. Live view

There are two ways to execute the live view function: with Internet Explorer, Mac Safari or Windows Chrome or with the **Remote Live Viewer** application.

5.1 Internet Explorer

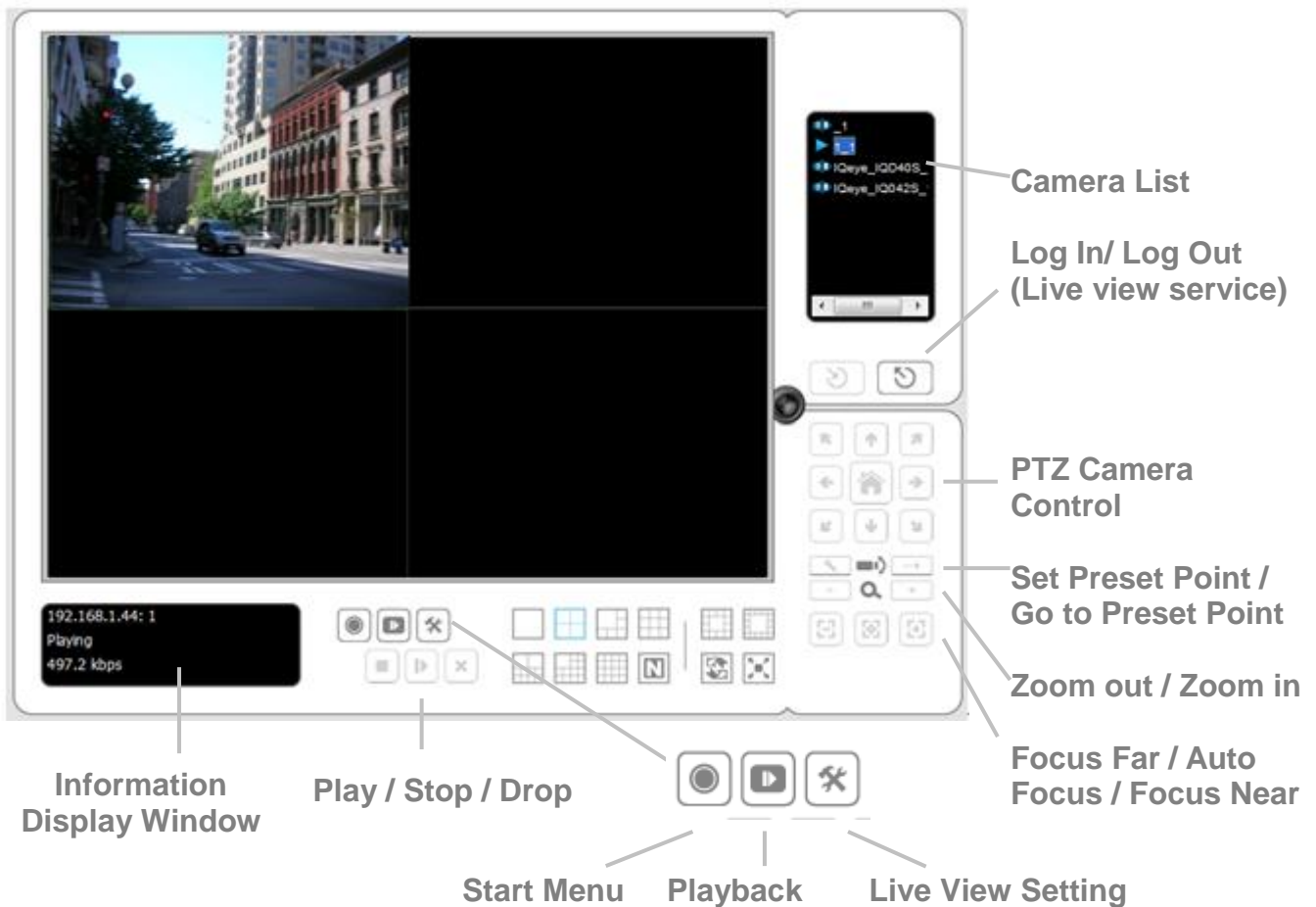
5.1.1 Live View Control Panel



- **PTZ Camera Control:** You may control the camera view by using the PTZ camera control panel to adjust the camera's view. This is only available with cameras that support the PTZ function.
- **Set Preset Point / Go to Preset Point:** Adjust the camera view and click the  button to set up this view as preset point. Repeat the process to add more preset points. Click the  button to see the preset view.
- **Zoom:** Click the **+** or **-** button to zoom in or zoom out the view.
- **Play / Stop / Drop:** Select a camera / video and click this button to play/stop/disconnect a particular channel.
- **Information Display Window:** Display video information including

- server name, video current status, and bit rate for a selected channel.
- **Start Menu > E-Map**: Upload map and drag camera or I/O on it to track device location and alarm status with instant response when an event occurred. See details in the chapter of **E-Map**.
- **Start Menu > I/O Control Panel**: Utilize I/O device function remotely. User can remotely adjust the Output Pins by turning it on or off.

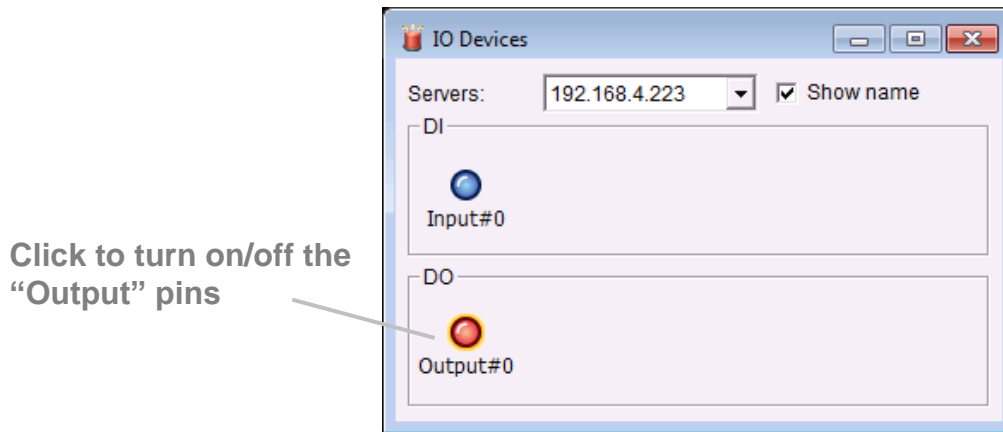

- **Playback**: View playback video remotely.
- **Auto Scan**: Activate auto scan to rotate the channels on the display screen. For instance, you may select to show only 4-split screen on the liveview, while connecting 16 channels to the system. With auto scan function, you are able to see all 16 channels by turns.
- **Layout**: Click to change the multiple-split layout.

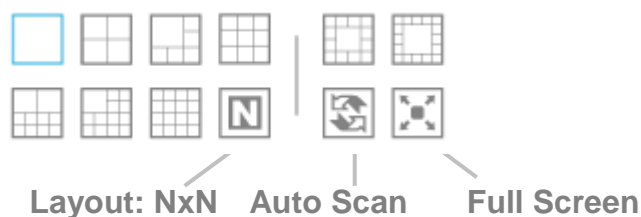

You can right click on the camera screen to enable the following function.

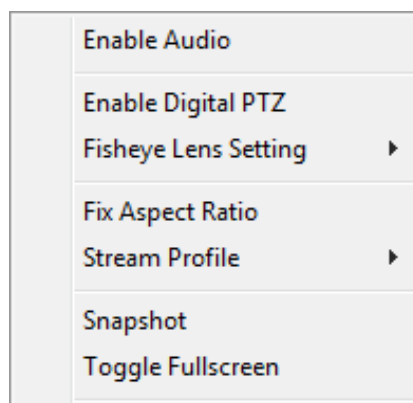

- **Enable Move**: Adjust the current view of camera which supports PT function by dragging the  button on the display screen.
- **Enable Digital PTZ**: Click the + or – button to zoom in or zoom out the view. The lower right square flashing on the video grid indicates the correspondent view of the camera.
- **Fisheye Lens Setting**: Select the mode of lens. There are four modes for **Generic Dewarp**, including Original, Rectilinear mode, Quad mode and Dual-view panorama mode; four modes for **ImmerVision**, including Original, PTZ mode, Quad mode and Perimeter mode; and other four modes for **Vivotek Fish Eye**, including Original, Rectilinear mode, Full-view panorama mode, Dual-view panorama mode. Type of modes depends on lens location.
- **Stream Profile**: Select the stream profiles, original, low, minimum.
- **Enable Audio**: Enable
- audio on active channel(s).
- **Snapshot**: Select the snapshot function to capture a specific video image immediately.
- **Toggle Fullscreen**: Select it to view cameras with full screen. Press “Esc” or right click un-select full screen to go back to the original view.

Also, right click on camera list to duplicate and connect/disconnect designate cameras, and do other functions.



- **Duplicate Camera**: Select the duplicate camera function to create multiple views. The duplicated camera will be shown with green indicator as the right picture. Combine this function with digital PTZ, users are allowed to enlarge different spots and view them in different channels without failing to record the whole view.
- **Connect / Disconnect**: Click to connect or disconnect the designate camera.
- **Login / Logout Server**: Click to login or logout.

- **Connect All / Disconnect All**: Click to connect or disconnect all cameras.

5.1.2 Live View Setting

1. Open Internet Explorer and log in to the unit.
2. Set the cameras.
3. Click the **Live View** button on the top of the page.
4. Select a camera(s) from the camera list on the right and then drag it to where you wish the image to be displayed.

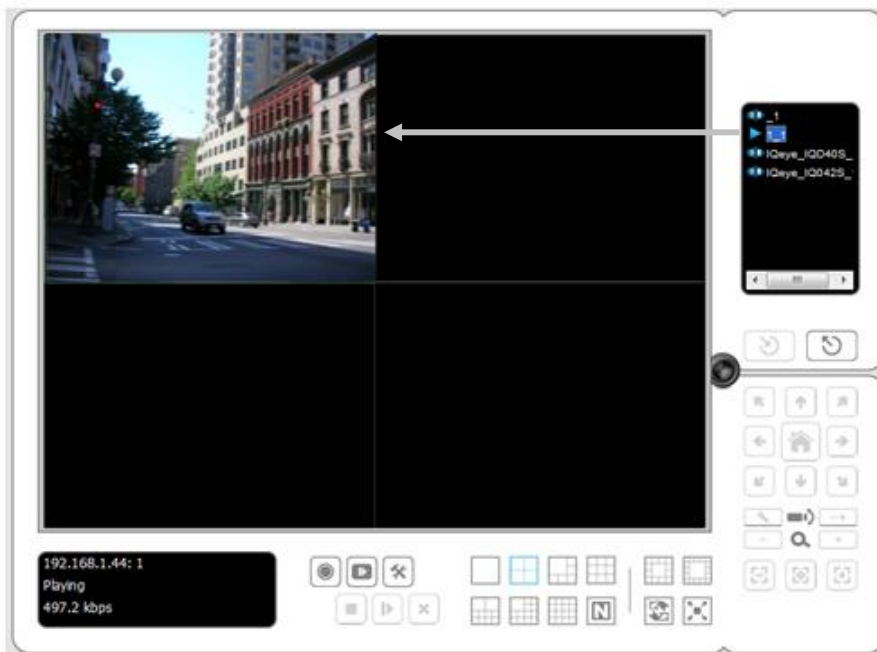

When running Internet Explorer, do not use the function "Open in New Window". Using this function may cause Internet Explorer to become unstable.

5.1.3 General Setting

1. Open Internet Explorer and log in to the unit.
2. Click the **Live View** button on the top of the page.
3. Click the **General Setting** button.
4. Click the **General** tab.

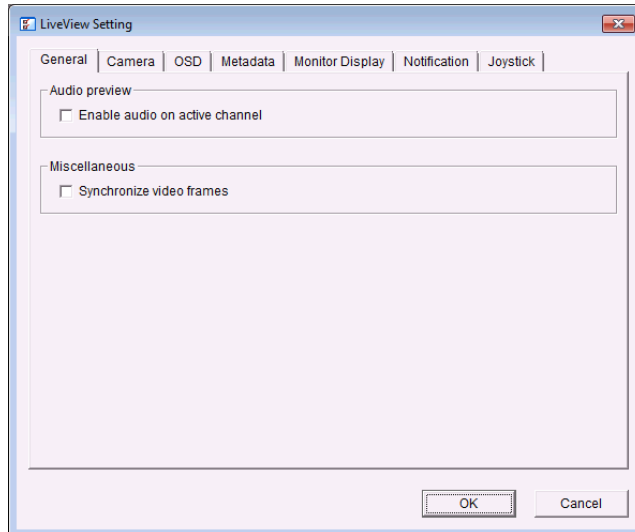

5. Check the **Enable audio on active channel** option to enable audio streaming on active channel. This function synchronizes with right click on camera to enable audio.
6. Check **Synchronize video frames** to avoid the tearing problem occurring in video display while increasing the CPU loading.
7. Click the **OK** button.

5.1.4 Stream Profile Setting

Select the preferred stream type of each camera as default live view profile.

1. Open Internet Explorer and log in to the unit.
2. Click the **Live View** button on the top of the page.
3. Click the **General Setting** button.
4. Click the **Camera** tab.

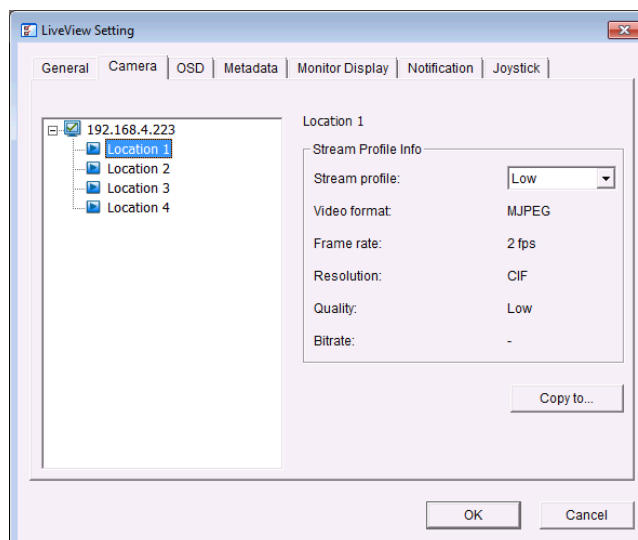

5. Adjust the stream profile of every camera with stream profile enabled in the **setting page**.
6. Click a camera and select its stream profile, and click the **Copy to...** button to apply this profile to other channels.
7. Click the **OK** button.

5.1.5 OSD (On-screen display) Setting

1. Open Internet Explorer and log in to the unit.
2. Click the **Live View** button on the top of the page.
3. Click the **General Setting** button.
4. Click the **OSD** tab.

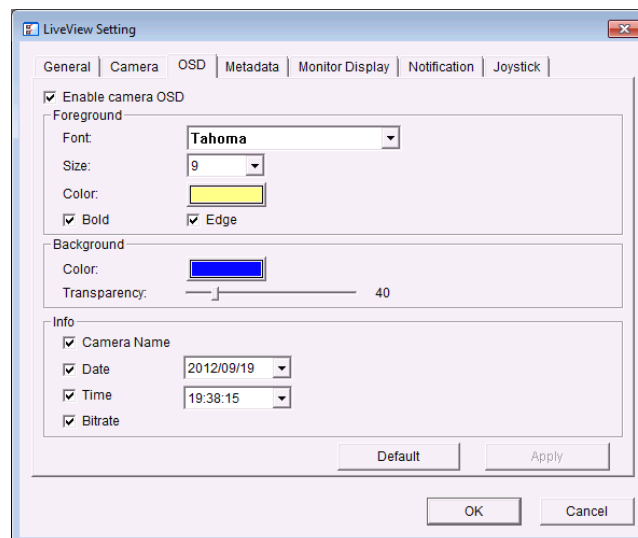

5. Check the **Enable camera OSD** option.
6. Set the foreground and background settings of the OSD.
7. Select which kinds of information will be displayed on the screen.
8. Click the **Apply** button to preview the result.
9. Click the **Default** button to back to the default settings if necessary.
10. Click the **OK** button.

5.1.6 Monitor Display Setting

1. Open Internet Explorer and log in to the unit.
2. Click the **Live View** button on the top of the page.
3. Click the **General Setting** button.
4. Click the **Monitor Display** tab.

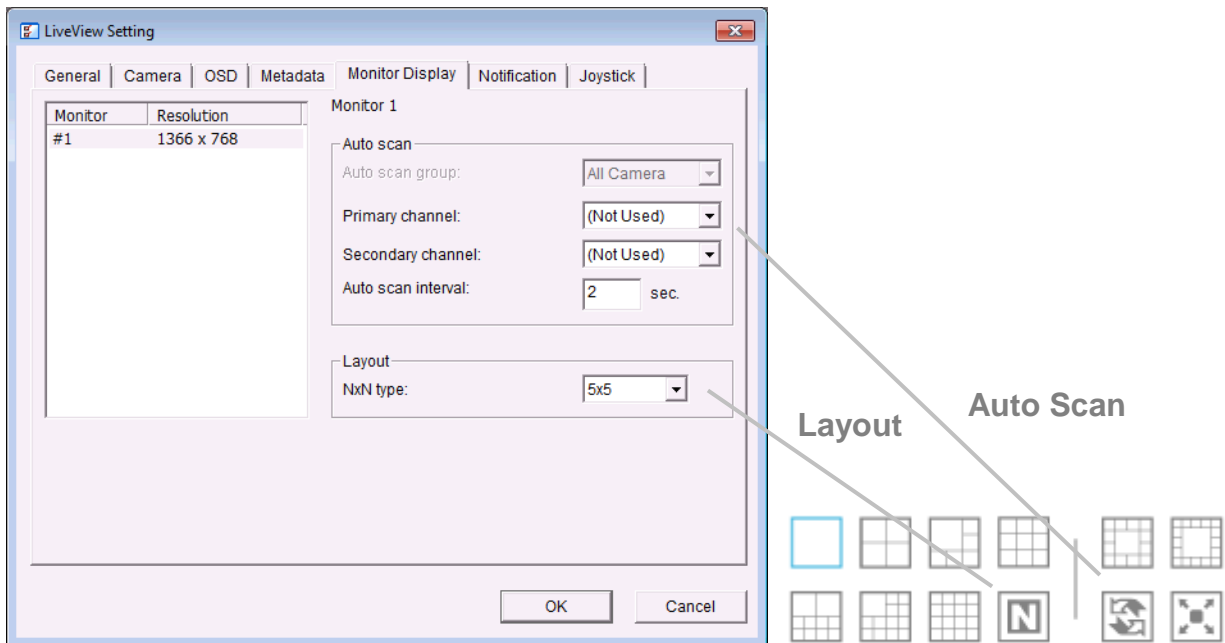

5. Select **Primary channel** which will always be on the screen when activating auto scan; while select **Secondary channel** which has second priority when activating auto scan. Enter the time interval for auto scan.
6. Select the screen division of NxN type.
7. Click the **OK** button.

5.1.7 Notification

1. Open Internet Explorer and log in to the unit.
2. Click the **Live View** button on the top of the page.
3. Click the **General Setting** button.
4. Click the **Notification** tab.

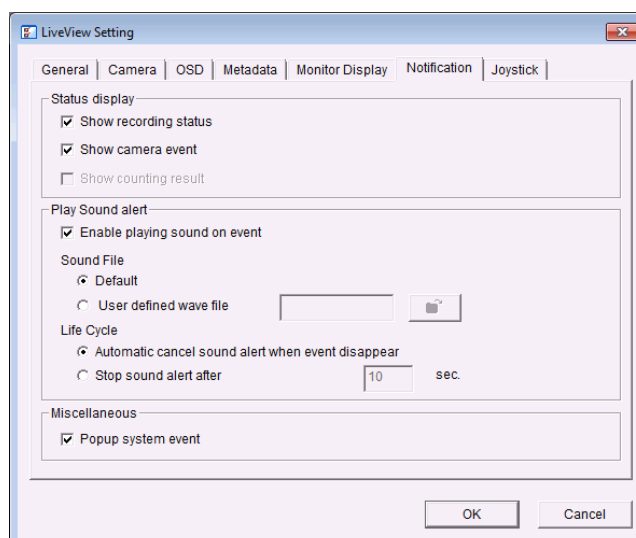

5. Check **Show recording status** to show the crystal ball with recording status on monitor display.
6. Check **Show camera event** to display the words of detected camera event on the correspondent screen.
7. Check the **Enable playing sound on event** option. Select sound file, default sound or user defined sound (.wav), and define the cycle.
8. Check **Popup system event** to pop up system event message dialog as a warning when a system event occurred.
9. Click the **OK** button.



The function only activates on event, which means you have to setup camera motion, camera I/O and I/O Box I/O as an event. Refer to **Event & Action Management** to do the setting.

5.1.8 Set up Joystick Control

1. Open Internet Explorer and log in to the unit.
2. Click the **Live View** button on the top of the page.
3. Click the **General Setting** button.
4. Click the **Joystick** tab.

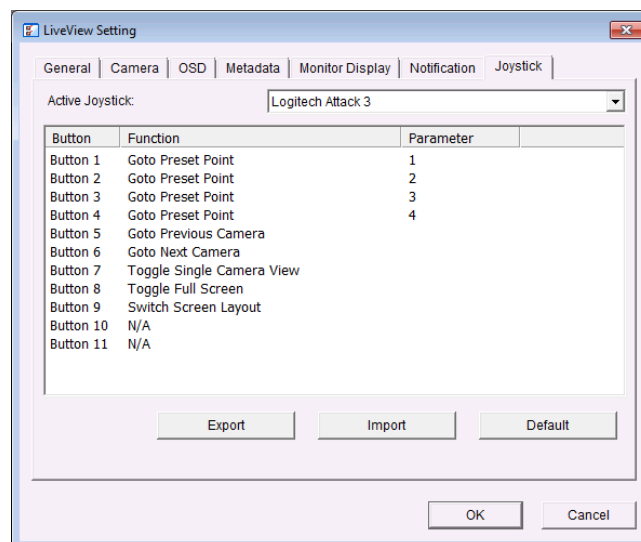

- **Function:** You can choose the function from the drop-down menu for the button of the joystick.

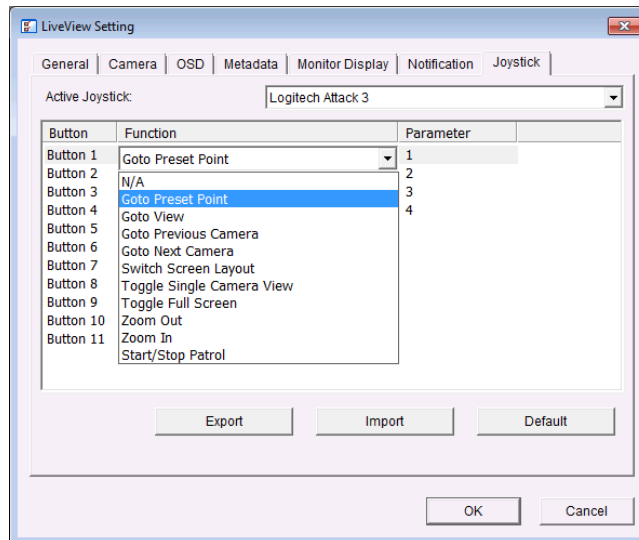



- **Parameter:** Choose the preset point from the drop-down menu.
- **Default:** Click to back to default setting.
- **Import:** Click to import the settings.
- **Export:** Click to export the settings.

5. Click the **OK** button.

5.2 Remote Live Viewer Application

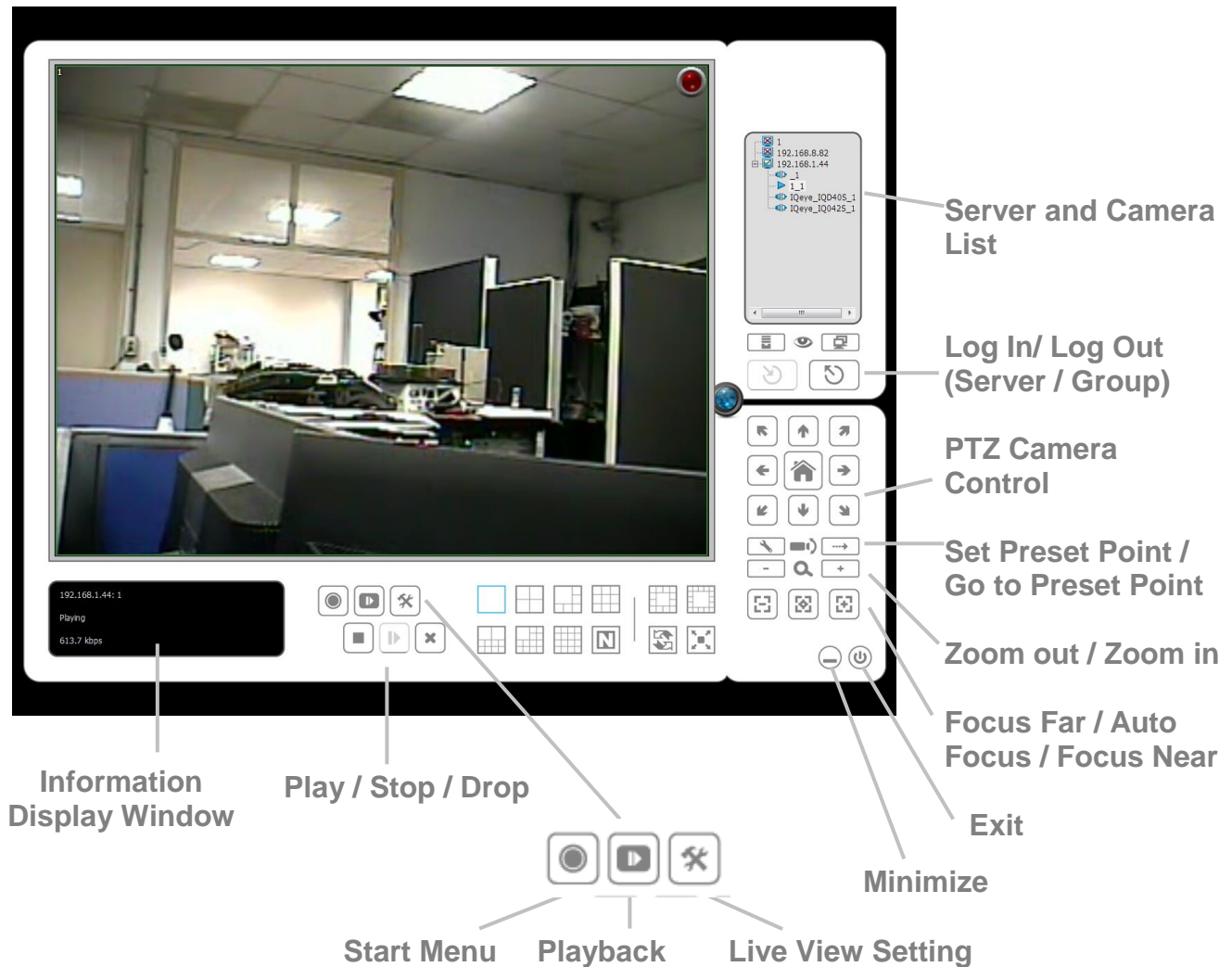
5.2.1 Remote Live Viewer Application Control Panel



- **PTZ Camera Control:** You may control the camera view by using the PTZ camera control panel to adjust the camera's view. This is only available with cameras that support the PTZ function.
- **Set Preset Point / Go to Preset Point:** Adjust the camera view and click the  button to set up this view as preset point. Repeat the process to add more preset points. Click the  button to see the preset view.
- **Zoom:** Click the + or – button to zoom in or zoom out the view.
- **Minimize:** Minimize the Remote Live Viewer window.
- **Exit:** Shut down the application.
- **Play / Stop / Drop:** Select a camera/ video and click this button to play/stop/disconnect a particular channel.
- **Information Display Window:** Display video information including

server name, video current status, and bit rate for a selected channel.

- **Start Monitor > Monitor**: Select Open Monitor to append monitor to view more live videos on multiple monitors.
- **Start Monitor > E-Map**: Upload map and drag camera or I/O on it to track device location and alarm status with instant response when an event occurred. See details in the chapter of **E-Map**.
- **Start Monitor > I/O Control Panel**: Utilize I/O device function remotely. User can remotely adjust the Output Pins by turning it on or off.

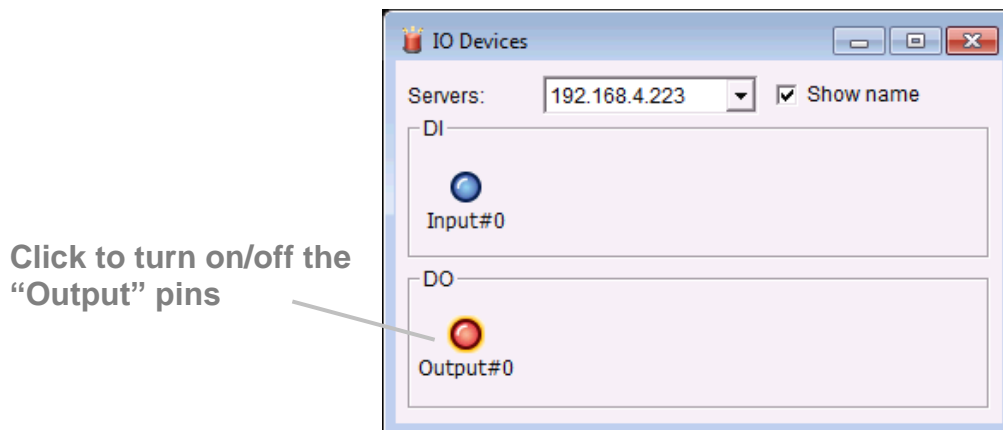

- **Playback**: View playback video remotely.
- **Auto Scan**: Activate auto scan to rotate the channels on the display screen. For instance, you may select to show only 4-split screen on the liveview, while connecting 16 channels to the system. With auto scan function, you are able to see all 16 channels by turns.
- **Layout**: Click to change the multiple-split layout.

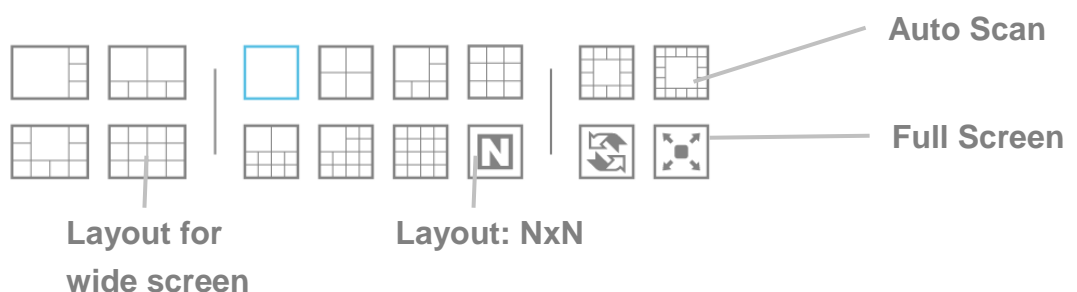

You can right click on the camera screen to enable the following function.

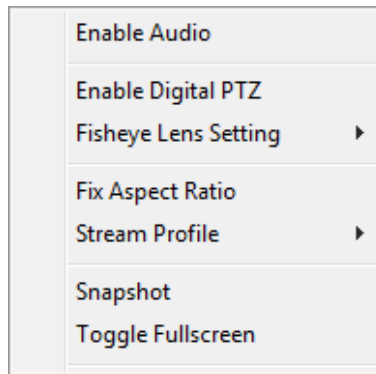

- **Enable Move:** Adjust the current view of camera which supports PT function by dragging the  button on the display screen.
- **Enable Digital PTZ:** Click the + or – button to zoom in or zoom out the view. The lower right square flashing on the video grid indicates the correspondent view of the camera.
- **Fisheye Lens Setting:** Select the mode of lens. There are four modes for **Generic Dewarp**, including Original, Rectilinear mode, Quad mode and Dual-view panorama mode; four modes for **ImmerVision**, including Original, PTZ mode, Quad mode and Perimeter mode; and other four modes for **Vivotek Fish Eye**, including Original, Rectilinear mode, Full-view panorama mode, Dual-view panorama mode. Type of modes depends on lens location.
- **Stream Profile:** Select the stream profiles, original, low, minimum.
- **Enable Audio:** Enable audio on active channel(s).
- **Snapshot:** Select the snapshot function to capture a specific video image immediately.
- **Toggle Fullscreen:** Select it to view cameras with full screen. Press “Esc” or right click un-select full screen to go back to the original view.

Also, right click on camera list to duplicate and connect/disconnect designate cameras, and do other functions.



- **Duplicate Camera**: Select the duplicate camera function to create multiple views. The duplicated camera will be shown with green indicator as the right picture. Combine this function with digital PTZ, users are allowed to enlarge different spots and view them in different channels without failing to record the whole view.
- **Connect / Disconnect**: Click to connect or disconnect the designate camera.
- **Login / Logout Server**: Click to login or logout.
- **Connect All / Disconnect All**: Click to connect or disconnect all cameras.

5.2.2 Unit Connection Setting

1. Startup > NVC > Remote Live Viewer.
2. Click the **General Setting** button.

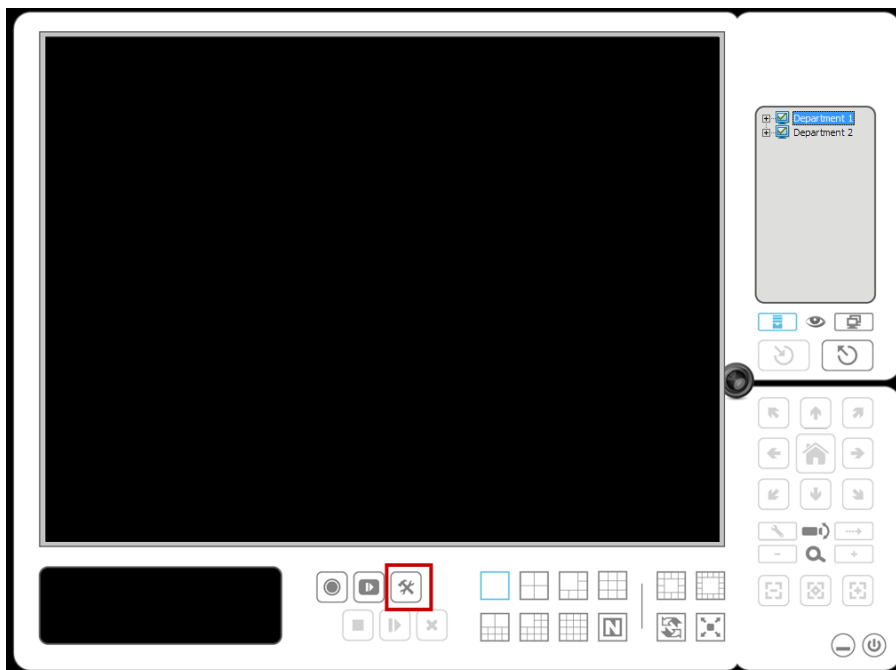

3. Click the **Server** tab.
4. Insert the unit name.

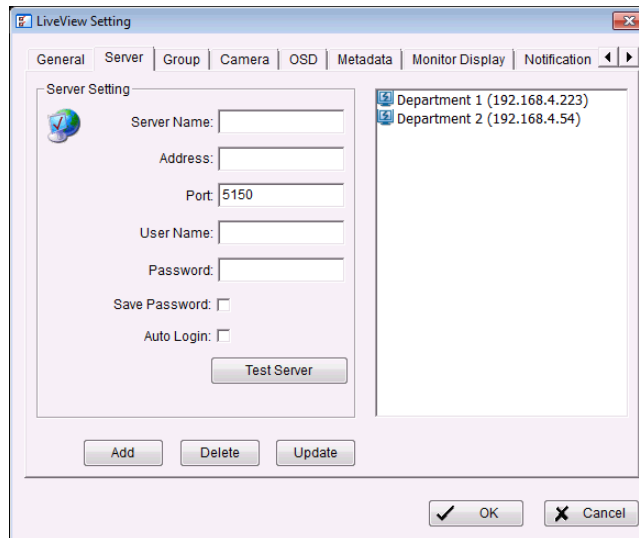

5. Insert the IP address.
6. Modify the port if necessary.
7. Insert the username.
8. Insert the password.
9. Check the **Save Password / Auto login** option.
10. Click the **Test Server** button to test the connection between the local application and the remote unit.
11. Click the **Add** button to add this unit into your remote server list.
12. Click the **OK** button.

5.2.3 General Setting

1. Startup > NVC > Remote Live Viewer.
2. Click the **General Setting** button.

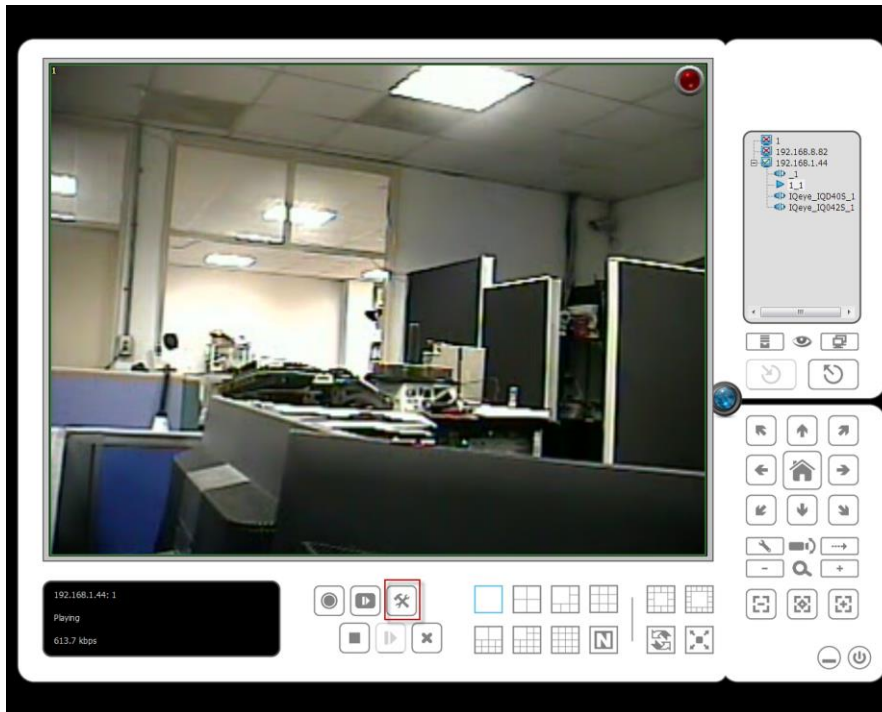

3. Click the **General** tab.

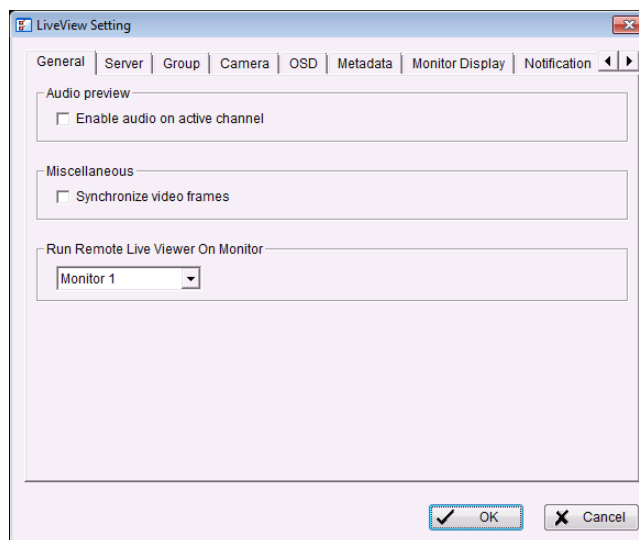

4. Check the **Enable audio on active channel** option to enable audio streaming on active channel. This function synchronizes with right click on camera to enable audio.
5. Check **Synchronize video frames** to avoid the tearing problem occurring in video display while increasing the CPU loading.
6. Select monitor(s) to run LiveView.
7. Click the **OK** button.

5.2.4 Camera Group Setting

You can put different cameras into the same group.

1. Startup > NVC > Remote Live Viewer.
2. Click the **General Setting** button.
3. Click the **Group** tab.

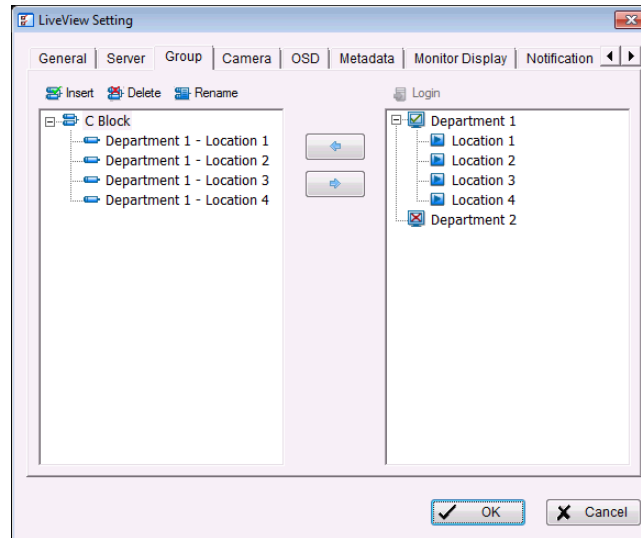

4. Log in to all the servers that contain the camera(s) you would like to put into the group(s).
5. Click the **Insert** button to create a new group.
6. Name this group.
7. Highlight the camera(s) that you would like to add into this group and then click the <-- button.
8. Repeat step 6 to establish the group.
9. Repeat steps 3 through 7 to establish other groups.
10. Click the **OK** button.

5.2.5 Delete/ Rename Camera Groups

1. Startup > NVC > Remote Live Viewer.
2. Click the **General Setting** button.
3. Click the **Group** tab.
4. Click the group which you want to modify.
5. Click the **Delete** or **Rename** button to remove or rename that group.
6. Repeat steps 3 and 4 to modify other groups.
7. Click the **OK** button.

5.2.6 Stream Profile Setting

Select the preferred stream type of each camera as default live view profile.

1. Startup > NVC > Remote Live Viewer.
2. Click the **General Setting** button.
3. Click the **Camera** tab.

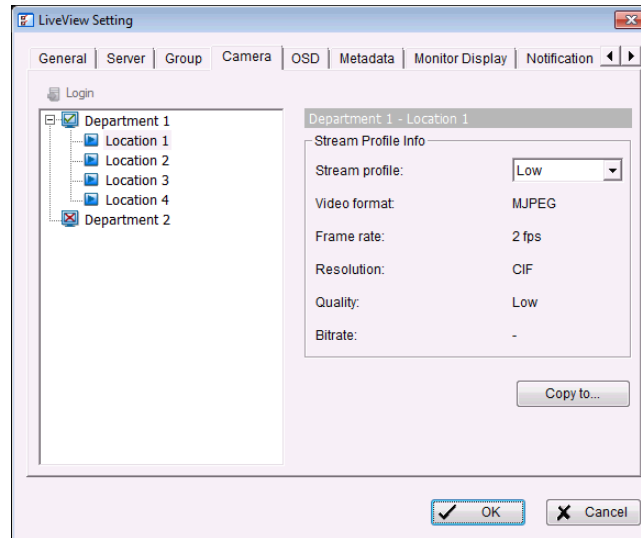

4. Adjust the stream profile of every camera with stream profile enabled in the **setting page**.
5. Click a camera and select its stream profile, and click the **Copy to...** button to apply this profile to other channels.
6. Click the **OK** button.

5.2.7 OSD (On-screen display) Setting

1. Startup > NVC > Remote Live Viewer.
2. Click the **General Setting** button.
3. Click the **OSD** tab.

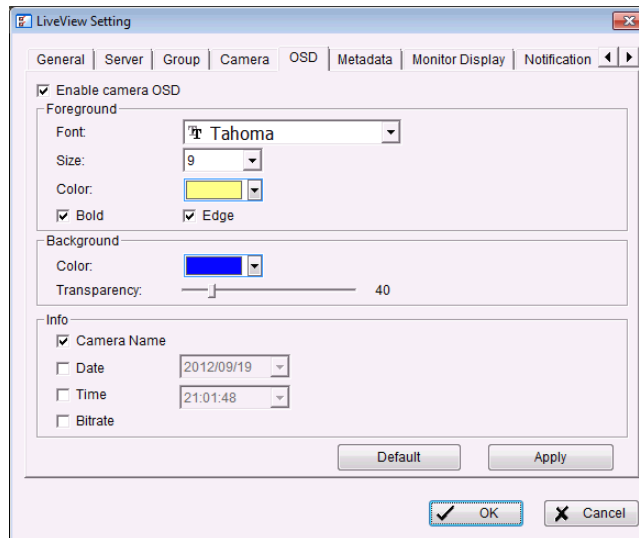

4. Check the **Enable camera OSD** option.
5. Set the foreground and background settings of the OSD.
6. Select which kinds of information will be displayed on the screen.
7. Click the **Apply** button to preview the result.
8. Click the **Default** button to back to the default settings if necessary.
9. Click the **OK** button.

5.2.8 Monitor Display Setting

1. Startup > NVC > Remote Live Viewer.
2. Click the **General Setting** button.
3. Click the **Monitor Display** tab.

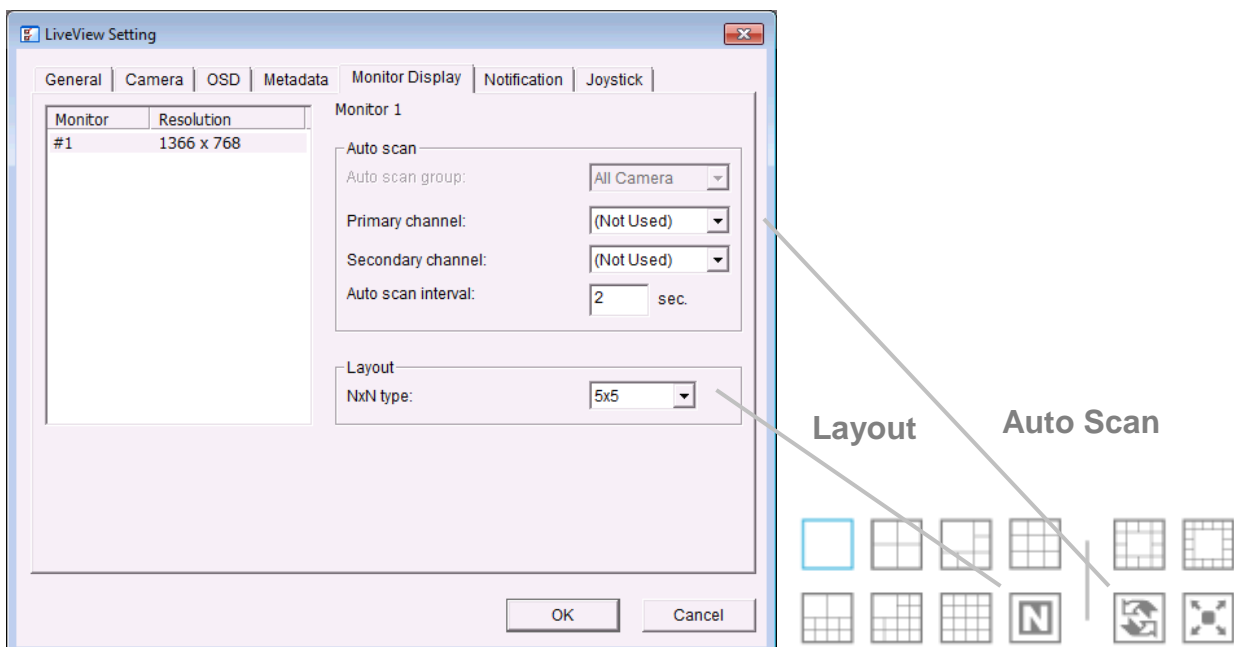

4. Select appointed server group to activate auto scan.
5. Select **Primary channel** which will always be on the screen when activating auto scan; while select **Secondary channel** which has second priority when activating auto scan. Enter the time interval for auto scan.
6. Select the screen division of NxN type.
7. Click the **OK** button.

5.2.9 Notification

1. Startup > NVC > Remote Live Viewer.
2. Click the **General Setting** button.
3. Click the **Notification** tab.

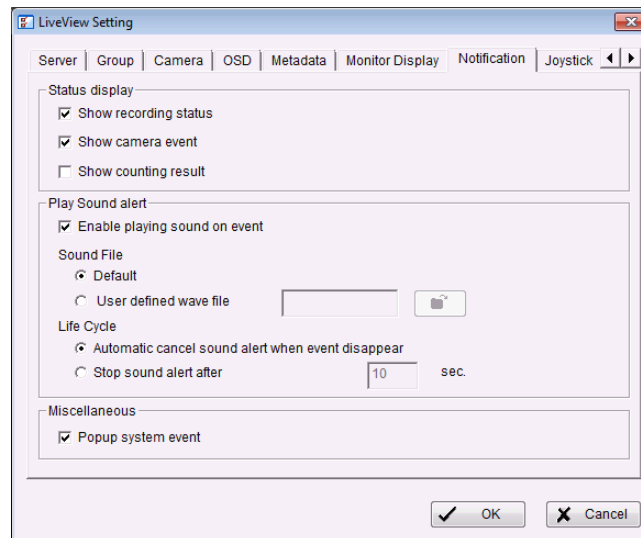

4. Check **Show recording status** to show the crystal ball with recording status on monitor display.
5. Check **Show camera event** to display the words of detected camera event on the correspondent screen.
6. Check the **Enable playing sound on event** option. Select sound file, default sound or user defined sound (.wav), and define the cycle.
7. Check **Popup system event** to pop up system event message dialog as a warning when a system event occurred.
8. Click the **OK** button.



The "playing sound" function only activates on event, which means you have to setup camera motion, camera I/O and I/O Box I/O as an event. Refer to **Event & Action Management** to do the setting.

5.2.10 Set up Joystick Control

1. Startup > NVC > Remote Live Viewer.
2. Click the **General Setting** button.
3. Click the **Joystick** tab.

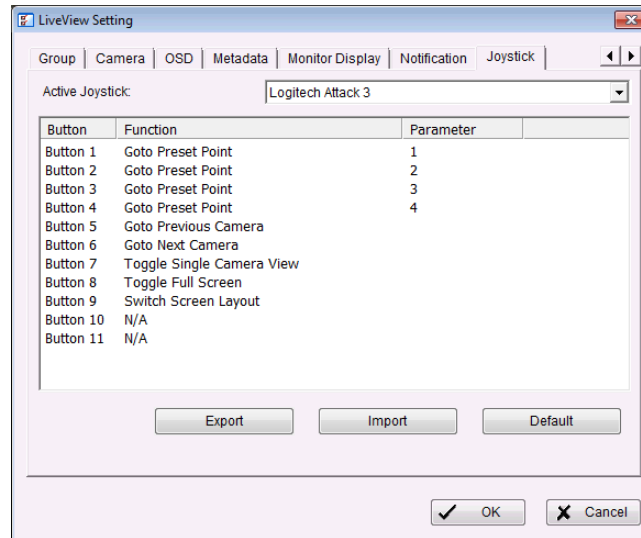

- **Function:** You can choose the function from the drop-down menu for the button of the joystick.

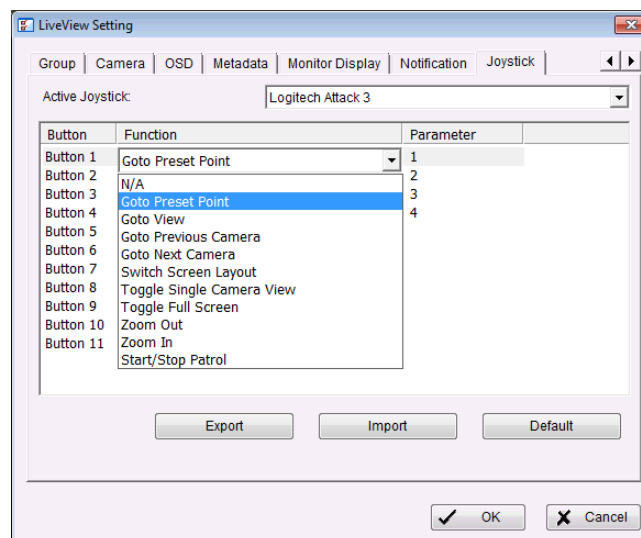

- **Parameter:** Choose the preset point from the drop-down menu.
- **Default:** Click to back to default setting.
- **Import:** Click to import the settings.
- **Export:** Click to export the settings.

4. Click the **OK** button.

5.2.11 Set up Remote Live Viewer



1. Startup > NVC > Remote Live Viewer.
2. Click the unit you wish to access in your remote server list.
3. Click the **LOG IN** button to access your unit.
4. Select a camera(s) from the camera list on the right and then drag it to where you wish the image to be displayed.

6.E-Map

There are two ways to execute the live view function: by Internet Explorer or by **Remote Live Viewer** application.

With E-map, user can easily track the device location and alarm status with instant response when an event occurs. The arrows and lightening icon on E-map represent cameras and I/O devices. These icons will turn red as being triggered by alarms.

There are two modes in E-map application, Edit Mode and Browse Mode.



-  **Edit Mode**: The function buttons on the bottom of this E-map dialog will be active. Users can add/edit/delete maps and indicators of devices.
-  **Browse Mode**: Users are not allowed to do any configuration but check the map hierarchies and device list to see indicators and related information.





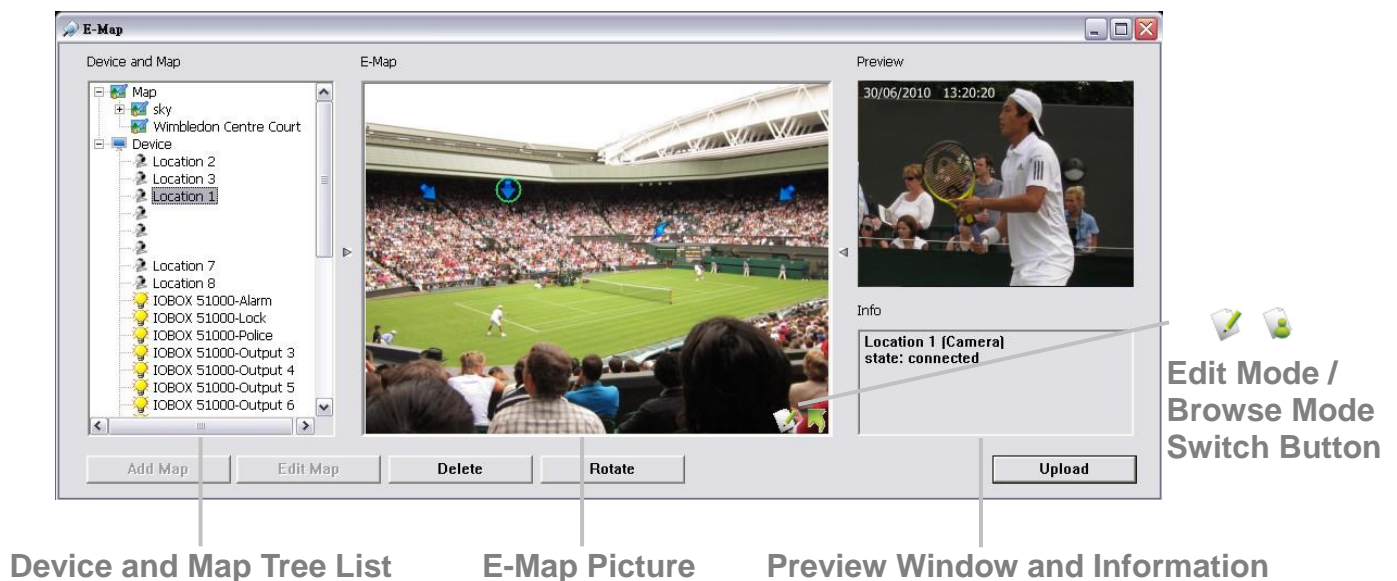

6.1 Internet Explorer

1. Open Internet Explorer and log in to the unit.
2. Click the **Live View** button on the top of the page.
3. Click the **Start Menu** button and select **Open E-Map**.

6.1.1 E-Map Control Panel



-  **Map**: Select a map you want to show on E-map Window.
-  **Camera**: Select the camera to see preview video or mark indicator on

- E-map.
-  **Digital Input**: Select it to highlight the device with green ring on map and show status on Information Window. If the Digital Input is from IP camera, the preview window will display live video of the camera.
-  **Digital Output**: Select it to highlight the device with green ring on map and show status on Information Window. If the Digital Output is from IP camera, the preview window will display live video of the camera.
-  **Map Indicator**: Clicking the indicator will lead to the next map layer. If you want to move to the upper layer, select it by mouse directly or click  icon on the map.
-  **Camera Indicator**: The indicator of cameras dragged from Device and Map Tree List to show preview video and related information. When event occurs, the color of indicator will turn red.
-  **Digital I/O Indicator**: The indicator of I/O devices dragged from Device and Map Tree List to show related information. When event occurs, the color of indicator will turn red.
- **Information Window**: The window shows the related information of each indicator.
 - **Map**: Show map name.
 - **Camera**: Show camera name and connecting status.
 - **Digital Input**: Show Digital Input name and status (0 or 1).
 - **Digital Output**: Show Digital Output name and status (0 or 1).

6.1.2 Add Map

1. Make sure being in "Edit Mode" and all devices are inserted and connected.
2. Right click on the Map icon  in Device and Map Tree List to obtain the option menu to add map, or just click the **Add Map** button to configure.



3. Select a map file and insert a name. Click the **OK** button, and then the map you added appears in the Device and Map Tree List.
4. The map indicator  appears on the upper left of map. Drag it to the position you want on appointed map.

5. Repeat steps 2 through 4 to add more maps.
6. Click the **Upload** button to activate all the settings.



The maximum file size of each map is 500KB. There are 10 layers of map, and the map capacity of each layer is 10.

6.1.3 Edit Map

1. Make sure being in "Edit Mode" and all devices are inserted and connected.
2. Right click on the Map icon  in Device and Map Tree List to obtain the option menu to edit map, or just click the **Edit Map** button to configure.
3. Repeat step 2 to edit more maps.
4. Click the **Upload** button to activate all the settings.

6.1.4 Delete Map

1. Make sure being in "Edit Mode" and all devices are inserted and connected.
2. Right click on the Map icon  in Device and Map Tree List to obtain the option menu to delete map, or just click the **Delete** button.
3. Repeat step 2 to delete more map.
4. Click the **Upload** button to activate all the settings.

6.1.5 Add/Rotate Device Indicator

1. Make sure being in "Edit Mode" and all devices are inserted and connected.
2. Select the map which you want to add device indicator on.
3. Select a device from list and directly drag it to the desired location on the map.
4. Select a camera indicator and right click on the indicator or click the **Rotate** button to adjust the direction of camera indicator if needed.
5. Repeat steps 2 and 4 to add more indicators on.
6. Click the **Upload** button to activate all the settings.

6.1.6 Delete Device Indicator

1. Make sure being in "Edit Mode" and all devices are inserted and connected.
2. Select the indicator and right click on the indicator or click the **Delete** button.
3. Repeat step 2 to delete more indicators.
4. Click the **Upload** button to activate all the settings.

6.1.7 Layout Adjustment

Adjust the Layout

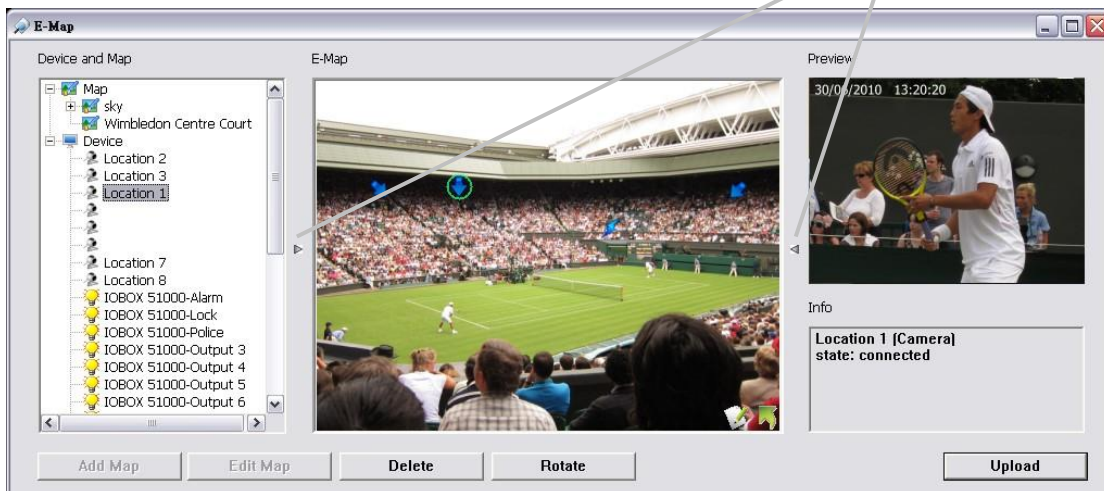

- ▶ ◀ **Adjust the Layout:** Click the triangular indicator to hide the Device and Map Tree List / Preview and Information Window on right and left side of the window. Click the indicator again to back to the default.
- ◻ **Maximize the Map:** Click the icon on the upper right to get the full screen display of E-map.

6.1.8 Relative Configuration and Application

When an event occurs, related E-map pops up to indicate the location of this event. Please check the **Notification** function for details.

6.2 Remote Live Viewer Application

1. Startup > NVC > Remote Live Viewer.
2. Click the **Start Monitor** button and select Open E-Map.

6.2.1 E-Map Control Panel



Device and Map Tree List

E-Map Picture

Preview Window and Information

- **Server List:** Select a server to display the E-map of the server.



The E-Map function of Remote Live Viewer is quite similar with the one in Internet Explorer, so you can refer to the section of **Internet Explorer** for the details.

7. Playback

There are two ways to execute the playback function: with Internet Explorer or with the **Playback System** application.

7.1 Internet Explorer

7.1.1 Playback Control Panel

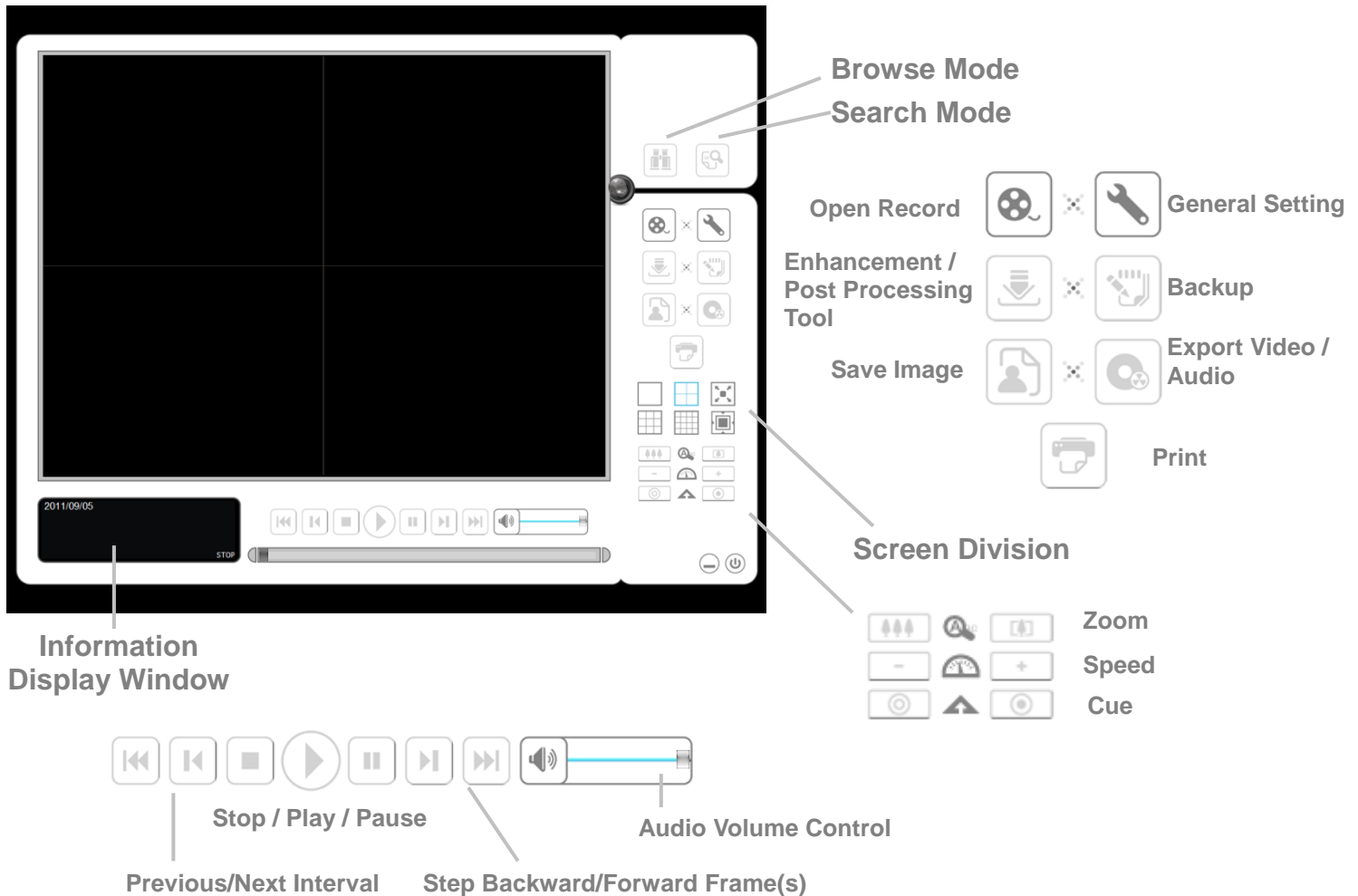

- **Information Display Window:** Displays video date and time, cue-in / cue-out point times, and speed.
- **Audio Volume Control:** Adjust the sound level.
- **Screen Division:** Allocate the sub-screen display by clicking on the desired layout icon. To switch to single camera display, double click a particular sub-screen. Double click the screen again to regain previous screen division layout.
- **Browse Mode:** Play the recorded video when in Search Mode.

- **Open Record**: Click the **Open Record** button to access the Date-Time Panel and select the video records which you want to review.
- **General Setting**
 - **Record Display**
 - Calendar View: view the Record Display Window as a calendar.
 - List Control: view the Record Display Window as a list control.
 - **Play**
 - Play when open: check this option to set the system to start playing the video clip every time a record is withdrawn.
 - Auto-skip when recording in motion-only mode: check this option to set up the system to automatically skip to the points where there were motions recorded.
 - Next interval: set the interval with which the video goes forward when you click the **Next** button on the control panel.
 - Previous interval: set the interval with which the video goes backward when you click the **Previous** button on the control panel.
 - **Capture Image**
 - Save in clipboard: the image will be saved in the clipboard and can be pasted to other application software.
 - Manually save the image file: you can manually select where you want to save the image, name the saved file, and choose the format you want to save the image.
 - Automatically save the image file: by presetting a path/URL and the image format, the system will automatically save the image accordingly when you click the **Save Image** button on the control panel.

You can right click on the camera screen to enable the following function.



- **Toggle Fullscreen**: Select it to view cameras with full screen. Press "Esc" or right click un-select full screen to go back to the original view.
- **Enable ImmerVision PTZ**: Adjust PTZ in PTZ mode.
- **ImmerVision Lens Setting**: Select the mode of lens, original, PTZ mode, Quad mode and Perimeter mode.
- **Enable Vivotek Fish Eye PTZ**: Adjust PTZ in PTZ mode.
- **Vivotek Fish Eye Setting**: Select the mode of lens, Original, Rectilinear

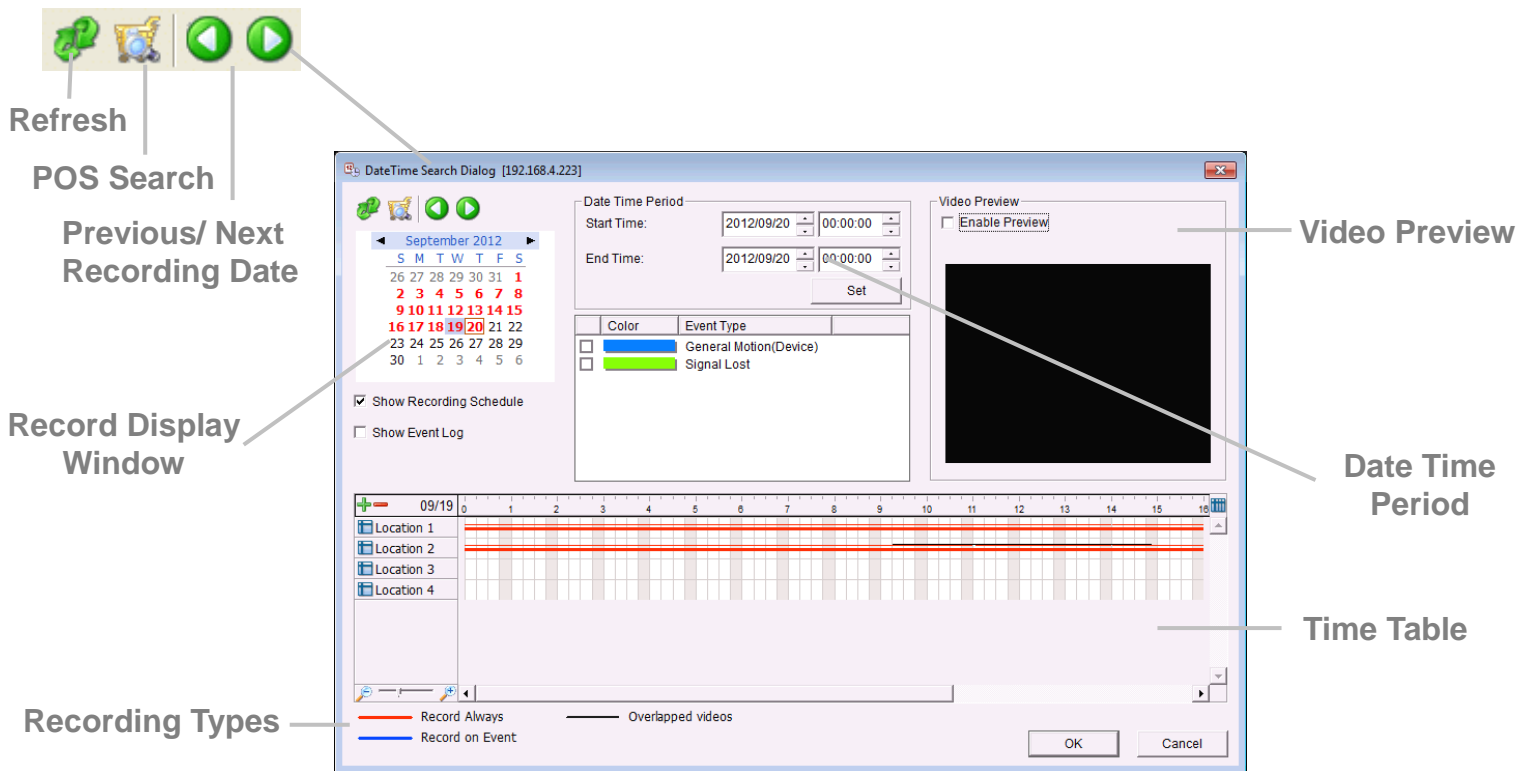

mode, Full-view panorama mode, Dual-view panorama mode. Type of modes depends on lens location.

7.1.2 Search the Recorded Video





- : refresh the Record Display Window.
- or : go to previous or next recording date.
- **Record Display Window**: Display the available recorded video records.
- **Date Time Period**: Select the start and end time points that indicate the time period you would like to view after choosing cameras.
- **Video Preview**: Check the **Enable Preview** option to view the selected video.
- **Time Table** (preset recording schedule): Click the icon to select all channels; click the icon to deselect all channels. Finally, use the scale bar to modify the scale of the time table.
- **Recording Types**: Red line in bold represents always record. Blue line in bold represents record on event. Red thin line represents recording data. Black thin line represents that there are multiple video clips within the same period due to system time change (e.g. daylight saving time)
- **Show Recording Schedule**: Show the period of recording schedule in the time table.

- **Show Event Log**: Show the time of event detection in the time table. Color of event type can be defined by preference.

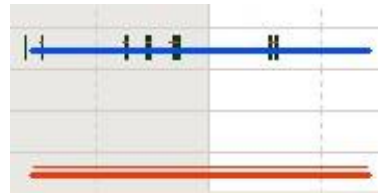
Color	Event Type
<input type="checkbox"/> 	General Motion(Device)
<input type="checkbox"/> 	Signal Lost

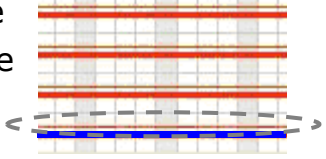

1. From the Record Display Window at the top left of the Date Time Panel, select the date you want to search the record from. The red lines shown on the time table indicate available recorded video records. 
2. Use color bars to differentiate recording types from each other. This will help you select video clips.
3. Highlight the video clip you want to review by left-clicking and dragging the time period. You may also utilize the Start Time and End Time in Date Time Period Section after choosing camera. In addition, modify the scale of the time table with the  or  icon on the bottom left.
4. If there are multiple videos of the time period you select, the following dialog may popup to guide you to select one to play.

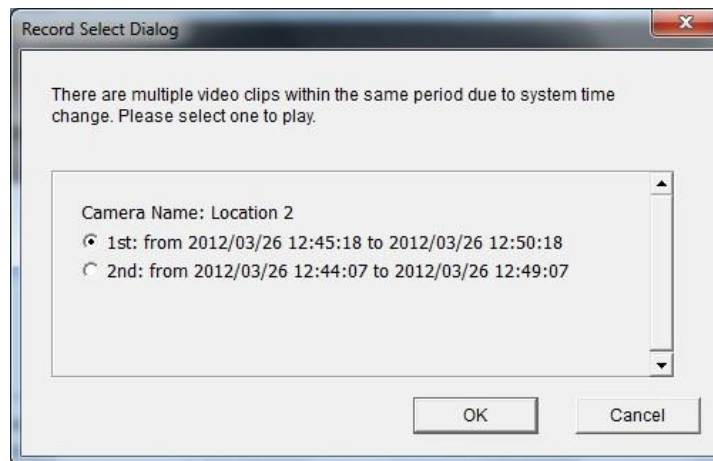

5. Check the **Enable Preview** option to get the preview of the video you select.
6. Click the camera name to increase or decrease cameras you want to playback.
7. Click the **OK** button.



The Record Display Window can be shown in (a) calendar view or (b) list control view. To modify the settings of the record display window, click the **General Setting** button at the right of the page.

7.1.3 Play the Recorded Video

1. Be sure that you have set the schedule / recording event first.
2. Open Internet Explorer and log in to the unit.
3. Click the **Playback** button on the top of the page.
4. Click the **Open Record** button.
5. The Record Display Window will show the information of the available video clips. Select the date you want to search the record from.
6. Highlight the video records that you want to review.
7. Click the **OK** button.

7.1.4 Intelligent Search

After opening the recorded video, click the **Search Mode** button to obtain the Intelligent Search Tool panel. You can search for unusual events during the recording period.

There are 5 types of unusual events: **General Motion**, **Foreign Object**, **Missing Object**, **Focus Lost**, and **Camera Occlusion**.

- **General Motion**: Detect all movements in the defined area.

1. Define detection zone by dragging to draw a detection zone. You may define more than one zone by repeating this step.
2. Modify the sensitivity setting by changing the slider control. Moving toward the right will increase the sensitivity level, which means a relatively small movement will trigger the alarm.
3. Set the interval. Moving toward right will increase time interval so that the alarm will only be triggered when the movement lasts longer.
4. Check the **Stop when found** option. If unchecked, the search tool will list all the events it found, instead of stopping at the moment the event found.
5. Click the **Search** button.

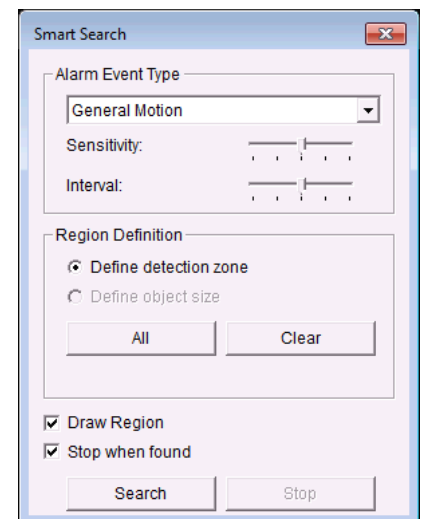

- **Foreign Object**: Alarm is set on when any additional object appears in the defined area on the screen.

1. Define detection zone by dragging to draw a detection zone.
2. Modify the sensitivity setting.
3. Set the Interval.
4. Check the **Stop when found** option. If unchecked, the search tool will list all the events it found, instead of stopping at the moment the event found.
5. Click the **Search** button.

- **Missing Object:** Alarm is set on when the selected object is removed from the defined area on the screen.

1. Define detection object by dragging to draw a detection zone.
2. Modify the sensitivity setting.
3. Set the Interval.
4. Check the **Stop when found** option. If unchecked, the search tool will list all the events it found, instead of stopping at the moment the event found.
5. Click the **Search** button.

- **Focus Lost:** System will inform you when the camera(s) lose its focus.
- **Camera Occlusion:** Alarms when the camera is blocked.

7.1.5 Recorded Video Enhancement

1. Open Internet Explorer and log in to the unit.
2. Click the **Playback** button on the top of the page.
3. Click the **Open Record** button.
4. The Record Display Window will show the information of the available video clips. Select the date you want to search the record from.
5. Highlight the video clip you want to review, and then click the **OK** button.
6. Click the **Enhancement** button.
7. Check the General Setting.

- **Apply active channel:** The settings will only be applied to the selected channel.
- **Apply all channels:** The settings will be applied to those currently shown on the screen.

8. Set the Filter Setting.

- **Visibility:** Check the option and adjust the gamma value of the image to enhance the image and make

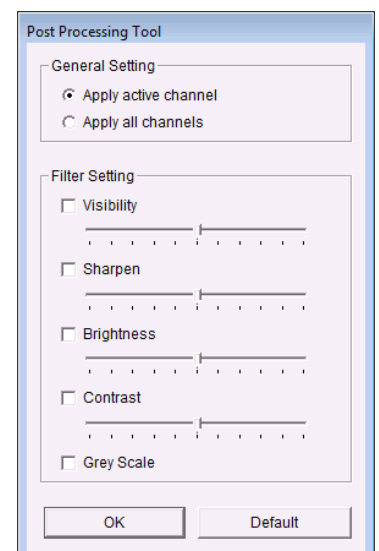

it cleaner.

- **Sharpen**: Check the option to activate the function. Move the slider control to the right to sharpen the image, to the left to soften it.
- **Brightness**: Check the option to activate the function. Move the slider control to the right to make the image brighter.
- **Contrast**: Check the option to activate the function. Move the slider control to the right to increase contrast.
- **Grey Scale**: Check the option to show the record in gray-scale mode so the image displays in black and white.

9. Click the **OK** button.

- **Stop**: Stop the enhancement function and close the enhancement tool. (The system will automatically back to the default settings.)
- **Default**: Back to the default settings, however, the enhancement tool still works.
- **OK**: Apply the modifications of the settings.

7.1.6 Save a Video

1. Open Internet Explorer and log in to the unit.
2. Click the **Playback** button on the top of the page.
3. Click the **Open Record** button.
4. The Record Display Window will show the information of the available video clips. Select the date you want to search the record from.
5. Highlight the video clip you want to review, and then click the **OK** button.
6. Choose the camera display that you want to save as a video clip.
7. Set up the cue in and cue out points; the cue in and cue out time will be shown on the information window.

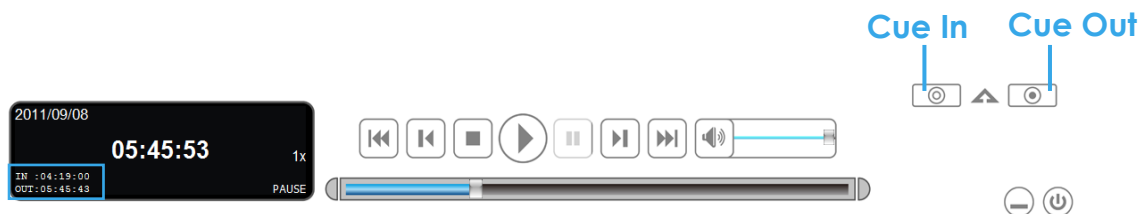

8. Click the **Save Video** button.

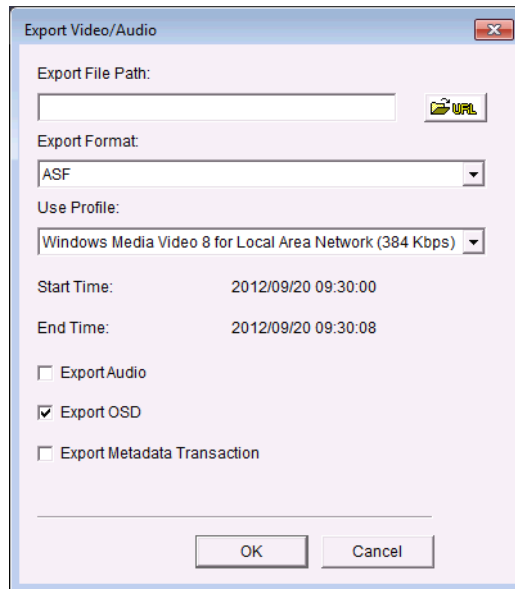

9. Choose the folder where you want to save the file.
10. Insert the file name and click the **Save** button.
11. Choose the export format.
12. Choose the use profile.
13. Check to export the recorded video with Audio, OSD and POS Transaction.
14. Click the **OK** button.



We recommend that you export to the .asf format when saving video. In exporting to the .avi format, the frame rate will be increased when playing in the video player, causing the video to run faster than normal.

7.1.7 Save an Image

1. Open Internet Explorer and log in to the unit.
2. Click the **Playback** button on the top of the page.
3. Click the **Open Record** button.
4. The Record Display Window will show the information of the available video clips. Select the date you want to search the record from.
5. Highlight the video clip you want to review, and then click the **OK** button.
6. Choose the camera display that you want to save pictures.
7. Click the **Save Image** button when the image you want is shown on the screen.
8. Choose the folder where you want to save the file at.
9. Choose the folder and the image format (BMP or JPEG) you prefer.
10. Insert the file name.
11. Click the **Save** button.



You may skip step 3 by presetting the folder where you want to save the images and the format you want to save them in.

7.1.8 Print an Image

Print the current image of the video you choose.

1. Open Internet Explorer and log in to the unit.
2. Click the **Playback** button on the top of the page.
3. Click the **Open Record** button.
4. The Record Display Window will show the information of the available video clips. Select the date you want to search the record from.
5. Highlight the video clip you want to review, and then click the **OK** button.
6. Choose the camera display from which you want to print pictures.
7. Click the **Print** button when the image you want is shown on the screen.
8. Set print settings.

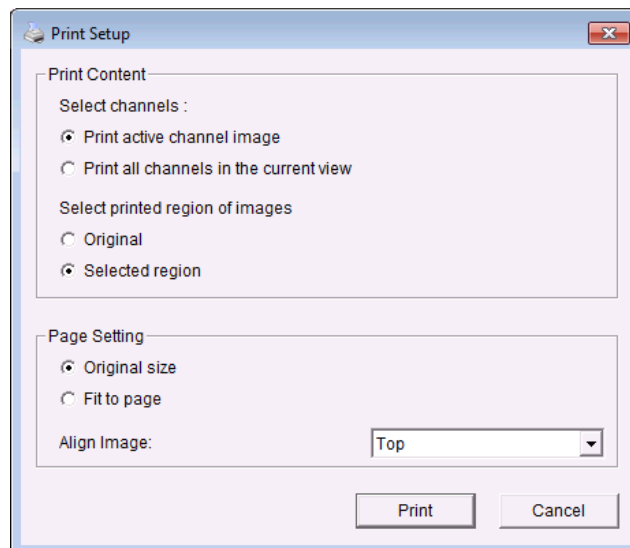

- **Print Content:** Print the image from currently selected channel or all the channels shown on the screen.
- **Page Setting**
 - **Print in original size:** Check to have the image print in original size.
 - **Fit the page:** Check to have the image fit the page.
 - **Align Image:** Top, center, or bottom

9. Click the **Print** button.

7.1.9 Backup the Recorded Video

Different from Save Video, the Backup function will save all the recorded videos which belong to the time slot you set, instead of the clips.

1. Open Internet Explorer and log in to the unit.
2. Click the **Open Record** button to select data.
3. Click the **Backup** button.

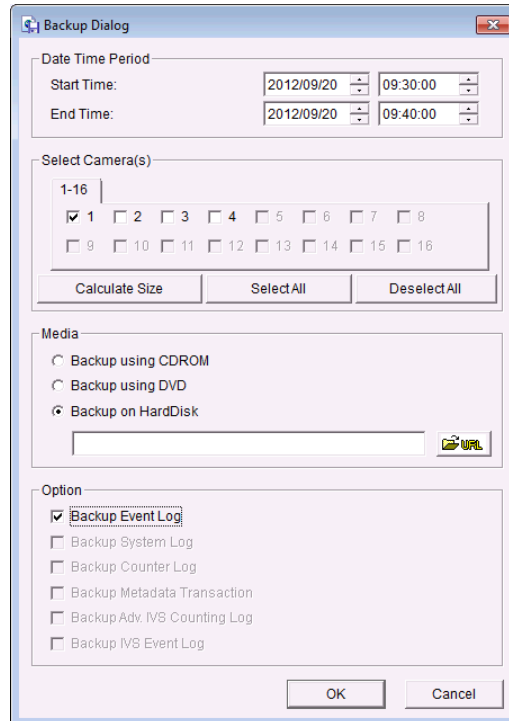

4. Set the Start Time and End Time you want to backup.
5. Select the cameras you want to backup.
6. Select the directory you want to save the backup data.
7. Click the **Backup** button.
8. The system will then begin backup process automatically.

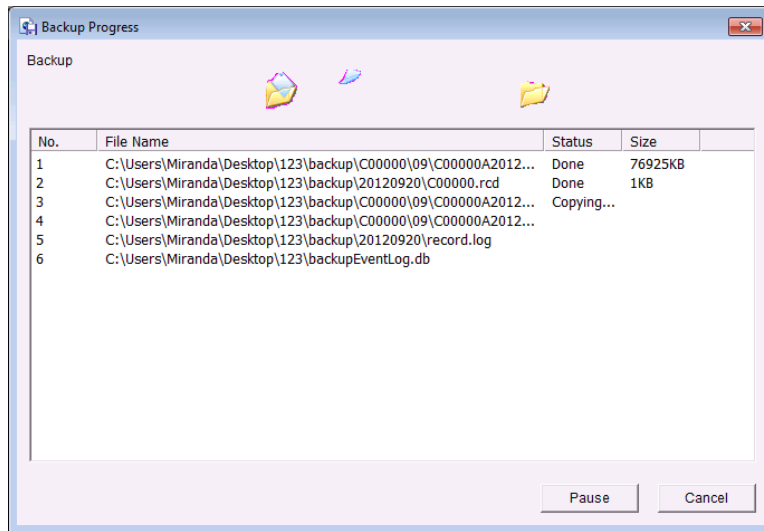

7.2 Remote Playback System Application

7.2.1 Playback System Application Control Panel

The **Playback System** control panel is similar to the playback panel in Internet Explorer. Check **Playback Control Panel** for more details about those buttons.

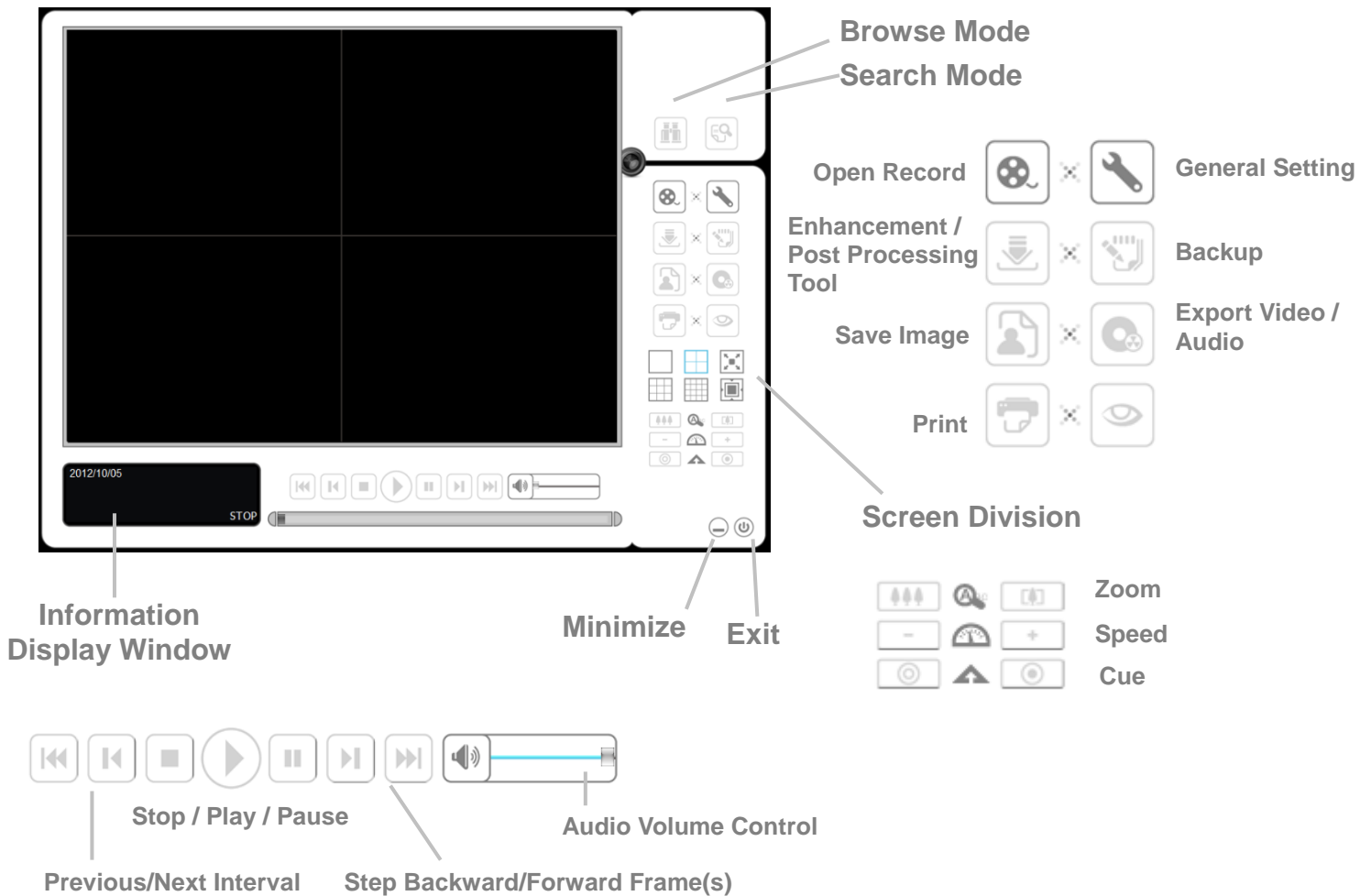

7.2.2 Set up Unit Connections

Before using the **Playback System** application, you need to set a connection to your unit first.

1. Startup > NVC > Playback System.
2. Click the **General Setting** button.
3. Click the **Server** tab.

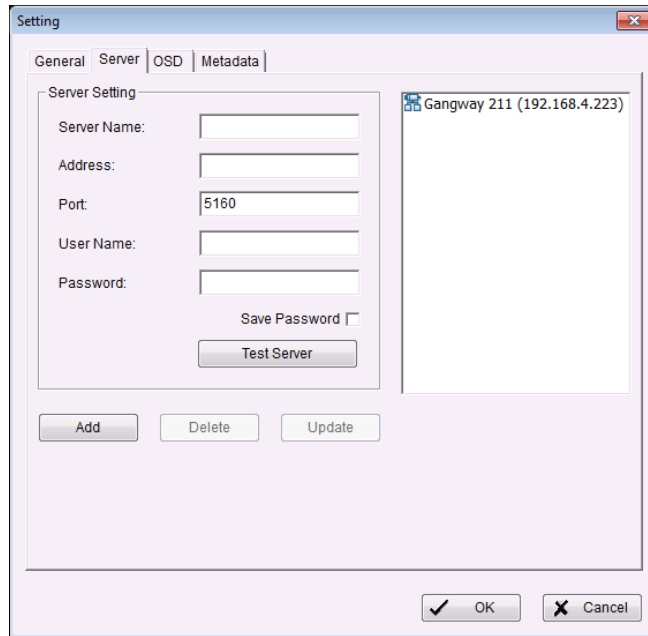

4. Insert the name of your unit.
5. Insert the IP address of that unit.
6. Modify the port if necessary.
7. Insert the username.
8. Insert the password.
9. Check the **Save Password** option.
10. Click the **Test Server** button to test the connection between the local application and the remote unit.
11. Click the **Add** button to add this unit into the remote server list.
12. Click the **OK** button.

7.2.3 Search the Recorded Video

Remote Playback
Site Management

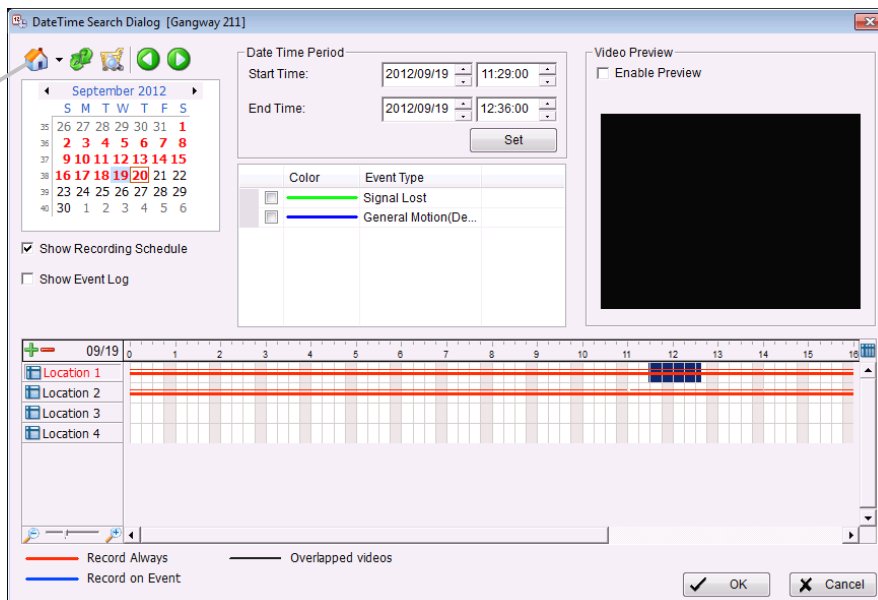

1. Startup > NVC > Playback System.
2. Click the **Open Record** button.
3. Click the  icon on the top of the Date-Time Panel to obtain the Remote Playback Site Management dialog, and then select the server you want to access.
4. Highlight the records you want to view in the Time Table.
5. Set the Date Time Period.

The search process in the **Playback System** application is similar to that of Internet Explorer. Check **Search the Recorded Video** for more details about the setting process.

7.2.4 Play the Recorded Video

1. Be sure that you have set up the recording schedule / response first.
2. Startup > NVC > Playback System.
3. Click the **General Setting** button and the **Server** tab to set connections to your unit. See **Set up Unit Connections** for more details.
4. Click the **Open Record** button.
5. The Record Display Window will show the information of the available video clips. Select the date you want to search the record from. Check **Search the Recorded Video** for more details.
6. Highlight the video records that you want to review.
7. Select the start and end points in Date Time Period to adjust the time slot.
8. Click the **OK** button.

7.2.5 Intelligent Search

1. Startup > NVC > Playback System.
2. Click the **Open Record** button.
3. The Record Display Window will show the information of the available video clips. Select the date you want to search the record from. Check **Search the Recorded Video** for more details.
4. Highlight the video records that you want to review.
5. Choose the camera display for which you want to implement smart search.
6. Click the **Search Mode** button to open the Intelligent Search Tool panel.
7. Set up unusual events here to detect abnormalities occurring during the recording period. Check **Intelligent Search** for more details.

8. The searched events will be listed. Click to find that event.

There are 5 types of unusual events: **General Motion**, **Foreign Object**, **Missing Object**, **Focus Lost**, and **Camera Occlusion**.

- **General Motion**: Detect all movements in the defined area.
- **Foreign Object**: Alarm when any additional object appears in the defined area on the screen.
- **Missing Object**: Alarm when the selected object is removed from the defined area on the screen.
- **Focus Lost**: System will inform you when the camera(s) lose focus.
- **Camera Occlusion**: Alarm when the camera is blocked.

The intelligent search in the **Playback System** application is similar to that of Internet Explorer.

7.2.6 Recorded Video Enhancement

1. Startup > NVC > Playback System.
2. Click the **Open Record** button.
3. The Record Display Window will show the information of the available video clips. Select the date you want to search the record from. Check **Search the Recorded Video** for more details.
4. Highlight the video records that you want to review.
5. Choose the camera display that you want to implement video enhancement.
6. Click the **Enhancement** button.
7. Check the General Setting.
 - **Apply active channel**: The settings will only be applied to the selected channel.
 - **Apply all channels**: The settings will be applied to those currently shown on the screen.
8. Set the Filter Setting.
 - **Visibility**: Check the option and adjust the gamma value of the image to enhance the image and make it cleaner.
 - **Sharpen**: Check the option to activate the function. Move the slider control to the right to sharpen the image, to the left to soften it.

- **Brightness:** Check the option to activate the function. Move the slider control to the right to make the image brighter.
- **Contrast:** Check the option to activate the function. Move the slider control to the right to increase contrast.
- **Grey Scale:** Check the option to show the record in gray-scale mode so the image displays in black and white.

9. Click the **OK** button.

- **Stop:** Stop the enhancement function and close the enhancement tool. (The system will automatically revert back to the default settings.)
- **Default:** Back to the default settings, however, the enhancement tool still works.
- **OK:** Apply the modifications of the settings.

7.2.7 Save a Video

1. Startup > NVC > Playback System.
2. Click the **Open Record** button.
3. The Record Display Window will show the information of the available video clips. Select the date from which you want to search the record. Check **Search the Recorded Video** for more details.
4. Highlight the video records that you want to review.
5. Choose the camera display that you want to save as a video clip.
6. Set up the cue in and cue out points; the cue in and cue out time will show on the information window.

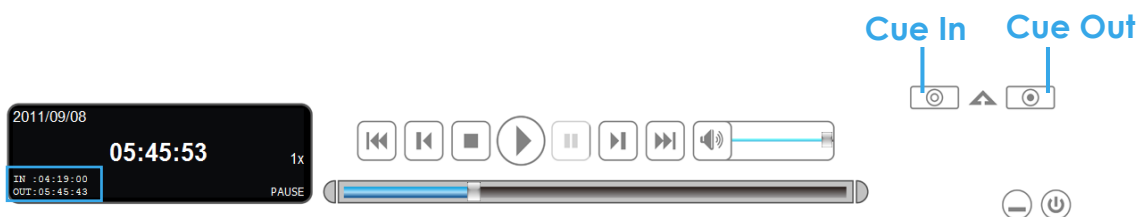

7. Click the **Save Video** button.
8. Choose the folder where you want to save the file.
9. Insert the file name and click the **Save** button.
10. Choose the export format.
11. Choose the use profile.
12. Check the **Export Audio** option.
13. Click the **OK** button.

7.2.8 Save an Image

1. Startup > NVC > Playback System.
2. Click the **Open Record** button.
3. The Record Display Window will show the information of the available video clips. Select the date from which you want to search the record. Check **Search the Recorded Video** for more details.
4. Highlight the video records that you want to review.
5. Choose the camera display from which you want to save pictures.
6. Click the **Save Image** button when the image you want is shown on the screen.
7. Choose the folder where you want to save the file at.
8. Choose the format of image (BMP or JPEG) you prefer.
9. Insert the file name.
10. Click the **Save** button.



You may skip step 7 by presetting a folder where you want to save the images and a format which you want to save the images in.

7.2.9 Print an Image

Print the current image of the video you choose.

1. Startup > NVC > Playback System.
 2. Click the **Open Record** button.
 3. The Record Display Window will show the information of the available video clips. Select the date you want to search the record from. Check **Search the Recorded Video** for more details.
 4. Highlight the video records that you want to review.
 5. Choose the camera display that you want to print pictures.
 6. Click the **Print** button.
 7. Set the print settings.
- **Print Content:** Print the image from currently selected channel or all the channels shown on the screen.
 - **Page Setting**
 - **Print in original size:** Select to have the image print in original size.
 - **Fit the page:** Select to have the image fit the page.
 - **Align Image:** Top, center, or bottom

7.2.10 Backup the Recorded Video

Different from Save Video, the Backup function will save all the recorded videos which belong to the time slot you set, instead of the clips.

1. Startup > NVC > Playback System.
2. Click the **Open Record** button to select data.
3. Click the **Backup** button.
4. Set the Start Time and End Time you want to backup.
5. Select the cameras you want to backup.
6. Select the directory you want to save the backup data.
7. Click the **Backup** button.

8.Backup and Delete Records

8.1 The Backup System Application

In addition to the ways mentioned in the previous chapters, you can apply the application to backup your files.

1. Startup > NVC > Backup System.

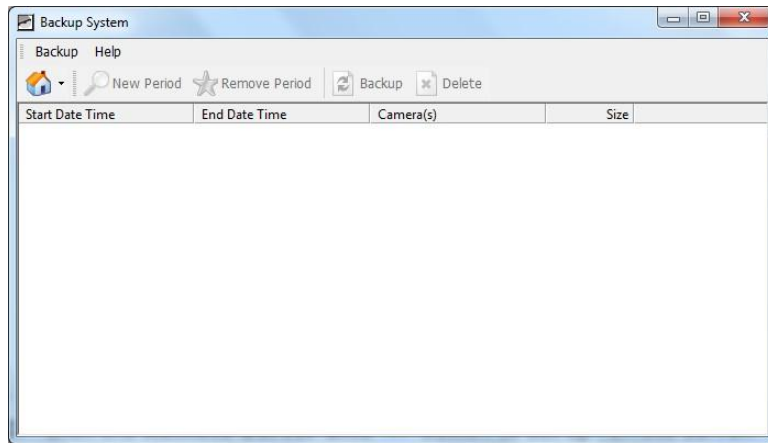

2. Click the **Remote Server Site**  button to set up remote server.

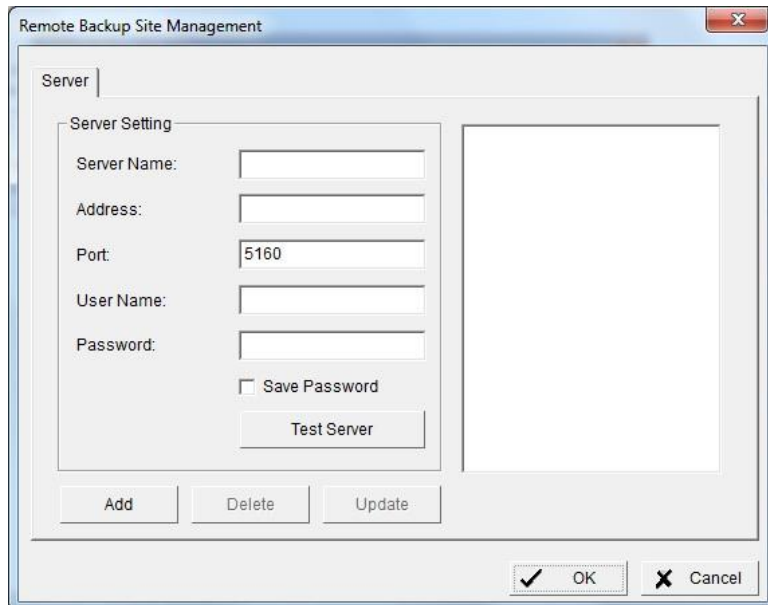

3. Insert the name of your unit.
4. Insert the IP address of that unit.
5. Modify the port if necessary.

6. Insert the username.
7. Insert the password.
8. Check the **Save Password** option.
9. Click the **Test Server** button to test the connection between the local application and the remote unit.
10. Click the **Add** button to add this unit into the remote server list.
11. Click the **OK** button.
12. Click the ▼ button next to **Remote Server Site** button, and select one of servers you added.

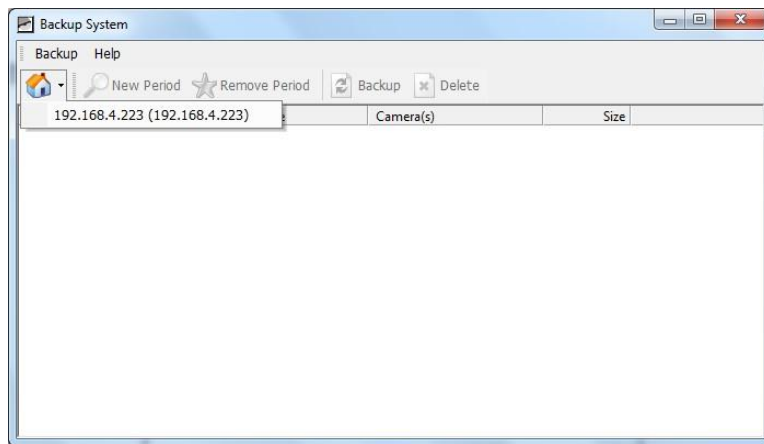

13. Click the **New Period** button to select the record date.

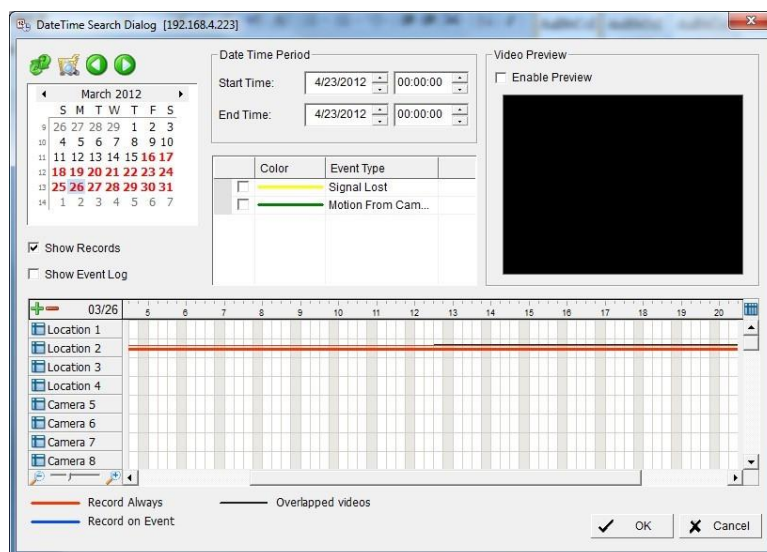

14. Set the Start Time and End Time you want to backup. (or highlight the video records which you want to backup)
15. Select the cameras you want to backup.
16. Click the **OK** button.

17. Select the time slot which you want to backup.

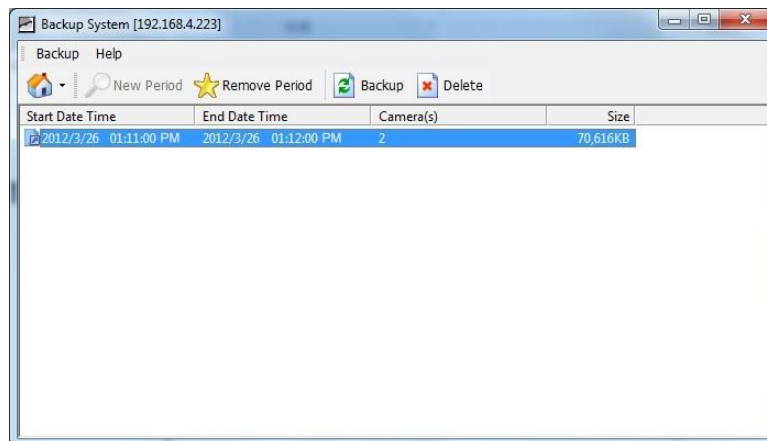

18. Click the **Backup** button.

19. Select the way and directory you want to save the backup data.

20. Check the **Include Playback application** option, which will add **Playback** application into the backup folder.

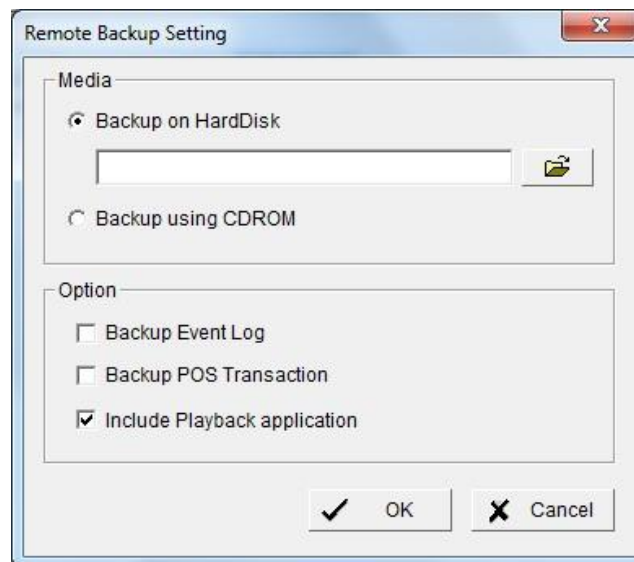

21. Click the **OK** button.

8.2 Backup the Recorded Video through FTP

1. Find your unit through Windows Explorer (insert "ftp://" plus the IP address of your unit)
2. Insert the name and password of the administrator.
3. Select the volume and open the "VIDEODATA" folder.

4. Copy the date folder which you want to backup to your desktop / laptop.

8.3 Playback the Backup Records

8.3.1 With Playback Application

1. Use the Backup System application to backup your records.
2. Check the **Include Playback application** option, which will add the **Playback** application into the backup folder.
3. Open that folder.
4. Double-click the Playback application icon.
5. Select the recorded data to play back.

8.3.2 Without Playback Application

1. Use the Playback function to backup your records.
2. Put your backup folder into the program folder of NVR. (Default directory is "C:\Program Files\NVR".)
3. Startup > NVC > Playback System.
4. Click the **Open Record** button.
5. Select the recorded data to play back.

8.4 Delete the Recorded Video

8.4.1 With Backup Application

1. Startup > NVC > Backup System.

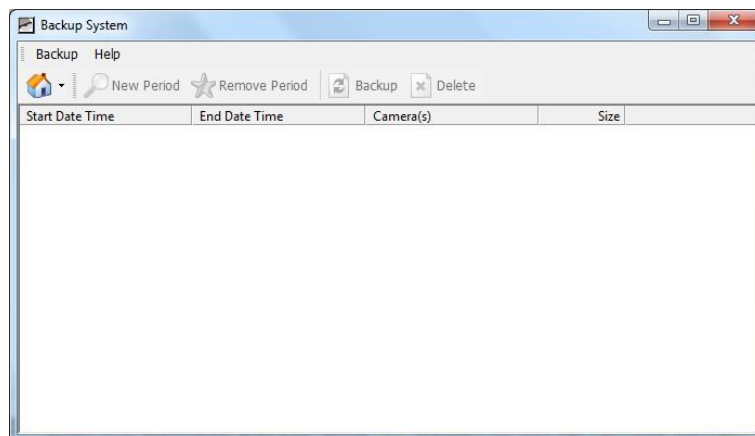

2. Click the **Remote Server Site**  button to set up remote server.

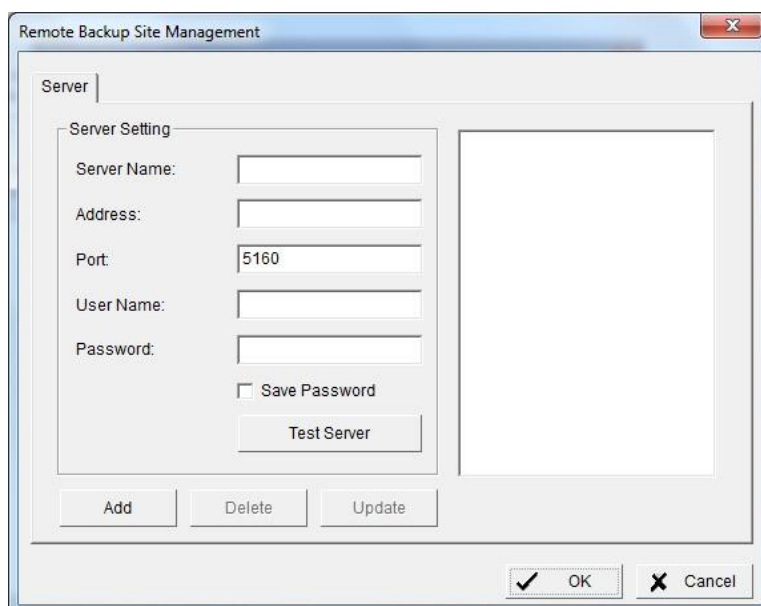

3. Insert the name of your unit.
4. Insert the IP address of that unit.
5. Modify the port if necessary.
6. Insert the username.
7. Insert the password.
8. Check the **Save Password** option.
9. Click the **Test Server** button to test the connection between the local application and the remote unit.
10. Click the **Add** button to add this unit into the remote server list.
11. Click the **OK** button.
12. Click the ▼ button next to **Remote Server Site** button, and select one of servers you added.

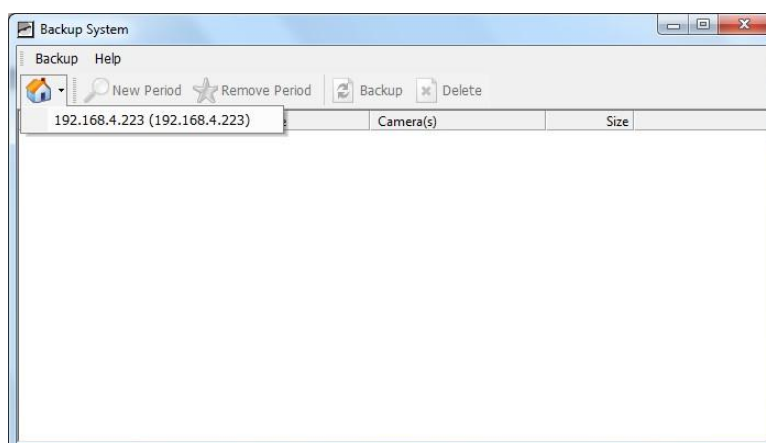

13. Click the **New Period** button to select the record date.

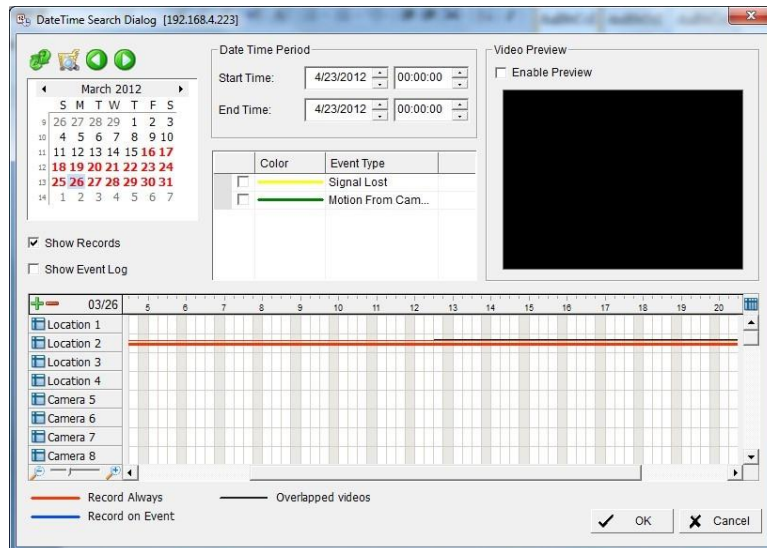

14. Set the Start Time and End Time. (or highlight the video records which you want to delete)
15. Select the cameras you want to delete the records.
16. Click the **OK** button.
17. Select the time slot which you want to delete.

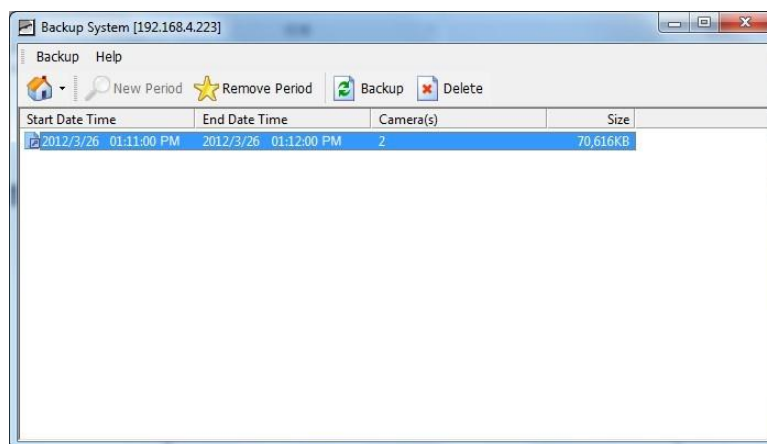

18. Click the **Delete** button.
19. Confirm the check dialog.

8.4.2 Without Backup Application

1. Find your unit through Windows Explorer (insert "\\\" plus the IP address of your unit).
2. Open the "public" folder.
3. Insert the name and password of the administrator.
4. Select the volume and open the "VIDEODATA" folder.

5. Select the date folder which you want to delete.
6. Delete the folder.





In order to keep the system stable, do not delete recorded data from the day in which you do the delete process.

9.Verification Tool

The Verification Tool verifies whether the data created by the system has been tampered with. It's the process by which a digital watermark (a digital signature) is added to each recorded video frame to ensure its authenticity.

There are three types of data could be verified by Verification Tool:

1. File in (.dat) (.264) format will be displayed as .
2. File in (.avi) (.asf) format will be displayed as .
3. File in (.bmp) (.jpg) format will be displayed as .

9.1 Execute Verification Tool

1. Startup > NVC > Verification Tool.
2. Verification Tool Overview

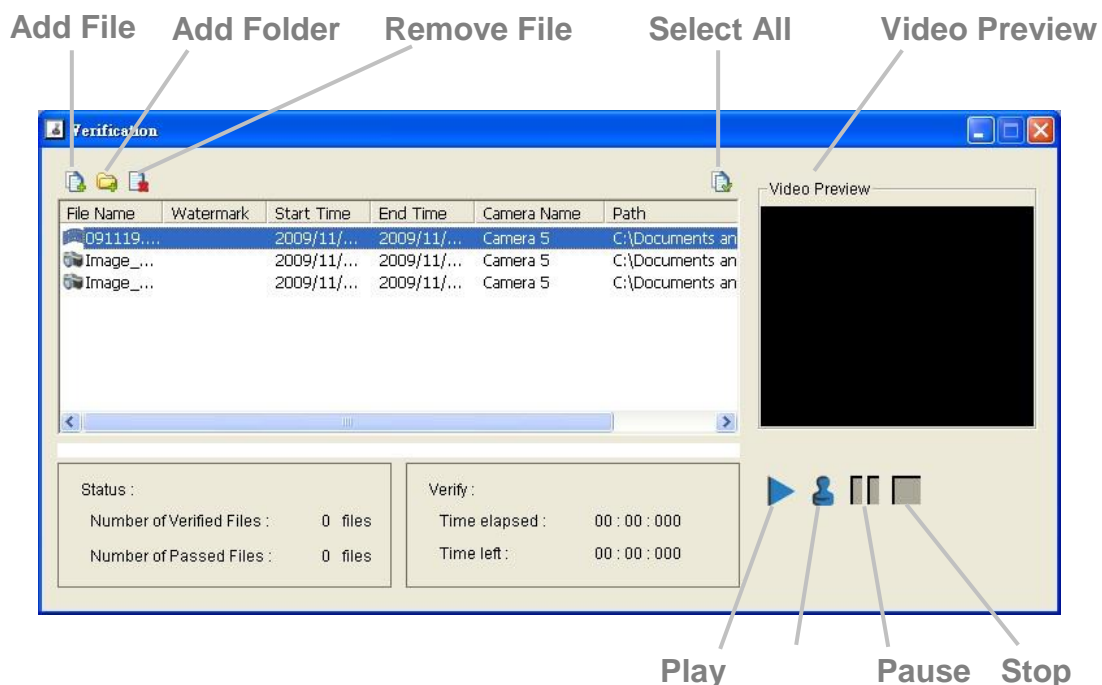

- **Add File**: Insert the single file to list for verification.
- **Add Folder**: Choose the folder with multiple files to list for verification.
- **Remove File**: Remove indicated file(s) from list.
- **Select All**: Select all files in list for verification.



Choose the file type first before selecting files. Only (.dat) (.264) (.avi) (.asf) (.bmp) (.jpg) are available to open.

- **Video Preview:** Preview designate file in verification list. Select the buttons below to play ▶, pause ||, and stop ■ the video file.

9.2 Verify Image / Video

1. Select single or multiple files for verification.
2. Click the **Verify** button to start verification.
3. The verification result will show on watermark column. If a file was tampered with, it will show ❌; if a file passed verification, it will show ✅.

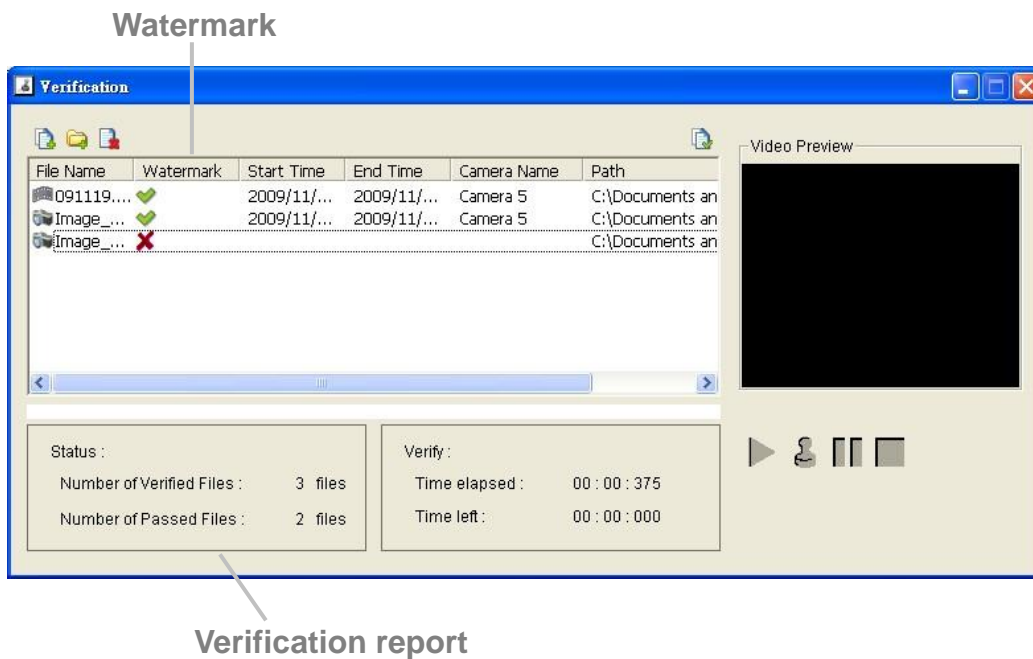

4. The verification report will indicate the information related to the verification.

10. External Storage

Total recording space can be expanded largely by connecting DAS through eSATA port. Follow the directions to enlarge your recording space.

10.1 Create a Volume on DAS

The current compatible DAS is AXUS FiT Series. We don't guarantee the quality of other DAS models. Please refer to the manual of AXUS FiT Series to create a single volume on DAS.



We are unable to create a volume on external storage in NVR setting page, so do NOT skip this step before connecting to NVR device.

10.2 Create an External Storage

1. Log in to the unit.
2. Click **RAID & File System / RAID Management**.
3. You will find External SATA Disk displayed in Disk List.

The screenshot shows the RAID Management interface. At the top, there are tabs for RAID Status, Modify, Create, Delete, and Format. The RAID Status tab is active. Below the tabs, there is a 'RAID Status' section with a 'List' table. The table has two columns: 'List' and 'Status'. In the 'List' column, there is a tree view showing 'Volumes' with 'VOLUME1' expanded, and 'Free Disks' with 'Disk 6 (eSATA)' highlighted by a red box. The 'Status' column shows details for VOLUME1: RAID Name: VOLUME1, RAID Level: RAID0, RAID Status: Functional, Total Capacity: 931.51 GB (953868 MB), Free Capacity: 583.5 GB (597504 MB), Used Capacity: 333.39 GB (341392 MB), Usage: 37% (indicated by a red progress bar), Update Time: Tuesday, August 16, 2011 2:56:17 AM, Total Devices: 1, Active Devices: 1, Failed Devices: 0, Spare Devices: 0, Format Progress, and Recovery Progress.

4. Click on the eSATA disk directly to check the disk drive information.

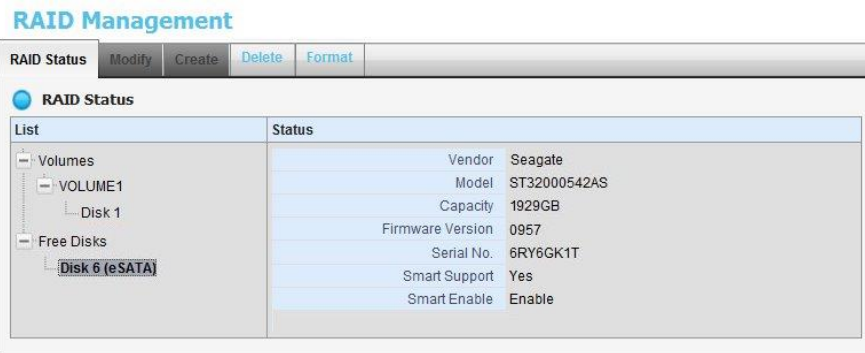

Refer to the section of **Create a RAID Volume** to create a volume for it.

11. Log out

Click the **Logout** button on the top of the page to log out of the system. If there is no action in 10 minutes, the system will log out automatically to avoid unauthorized access.

12. Remote PC System Requirements

Remote PC Minimum Requirements	
Model	1/8 bay
OS Supported	Windows XP 32 bit, Windows 7 32/64 bit, Windows 8 32/64 bit
CPU	Intel Core 2 Duo, 2.6GHz
RAM	1GB
User Interface	1. HTTP Web browser - Internet Explorer 8, 9, 10 (32 bit) 2. NVR Client application program

12.1 UPnP Support

In remote PC system, user can find all the camera devices in the Windows “Network”. As a result user can mass upgrade SNVRs/ IPCs at one time by using IPInstaller.



This feature is only for certain cameras: NUUO/ Zavio IPC only.

13. Troubleshooting

13.1 Replace a Failed Disk Drive

If a disk drive fails, the Disk Status LED becomes orange. If the disk drive belongs to a RAID Volume, the Volume goes Critical or Offline, depending on RAID level. See **Check RAID Volume Status** for details.

Replace the failed disk drive with a new disk drive of the same or slightly greater capacity. You do not have to power down the unit. Refer to **Modify RAID Volume** to remove the failed disk and replace it with a new one.

13.2 Respond to a Critical RAID Volume

How the unit responding to a Critical RAID Volume depends on the RAID level of your Volume:

- For **RAID 1, 5, and 10** volumes, you must replace the failed disk drive with a new one. The RAID Volume will begin rebuilding itself when you install the new disk drive. See **Replace a Failed Disk Drive** for details.
- **RAID 0** volumes go offline after a disk drive failure. A **RAID 0** Volume cannot be recovery. All data of the volume is lost.

13.3 Respond to a File System Error RAID Volume

When encountering file system error, you are unable to keep the data anymore. It's likely due to abnormal usage and disk damage. In this case, if you want to keep recording, we suggest replacing new disks, or try the following methods.

1. Format this volume, and check if the status becomes **functional**. If yes, you can start recording. If it doesn't, try the second method.
2. Delete this volume, and create volume again to see if the status is **functional**.

13.4 Restore the Default Administrator's Password

If you forget the password, and want to reset the Administrator's password to the default password: **admin**, follow the following steps.

1. Verify that the system is fully booted.
2. Insert your reset tool into the reset button hole on the back of the device.
3. Press and hold the reset button for 8 seconds, release your hands until the buzzer beeps one time and the System Status LED flashes in blue.
4. System will restart and the Administrator's password is now reset to **admin**.

13.5 Restore All Default Configuration

If you want to restore all configurations to default setting, follow the following steps.

1. Verify that the system is fully booted.
2. Insert your reset tool into the reset button hole on the back of the device.
3. Press and hold the reset button for 14 seconds, release your hands until the buzzer beeps twice and the System Status LED flashes in orange.
4. System will restart and all settings are reset to default.



RAID volume and data within the volume won't be reset to default. Refer to **Format** for the details.

13.6 Install ActiveX

If you cannot see the complete page of the system when using Internet

Explorer, it may be because the ActiveX installation process is not completed.

1. Open Internet Explorer and log in to the unit.
2. Click the **Live view / Playback** button on the top right.
3. The browser will ask whether to install ActiveX.

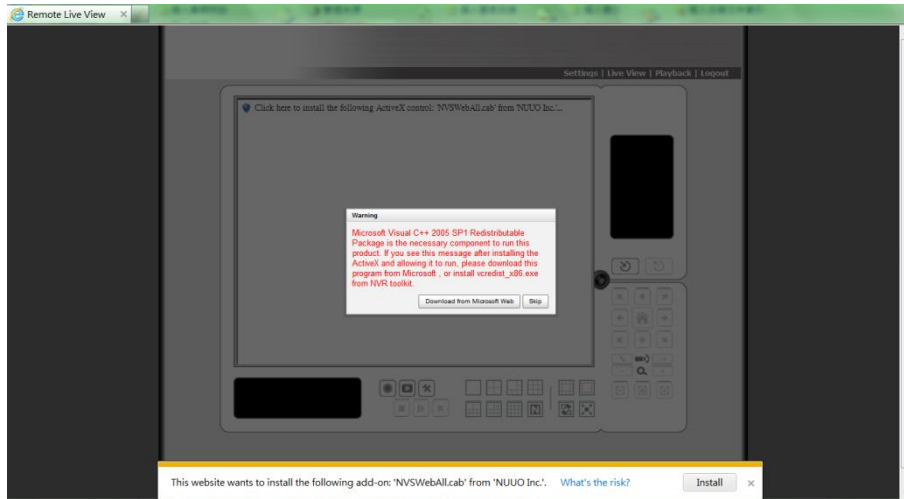

4. Click the upper bar to begin the installation process.
5. Click the **Install** button to complete the process.

13.7 Cannot Log in to the Unit with Internet Explorer

1. Check the settings of your antivirus software.
2. Change to appropriate settings or turn off this antivirus software.

Appendix – RAID System

Introduction to RAID

RAID (Redundant Array of Independent Disks) allows multiple disk drives to be combined together into a RAID Volume. You will create a RAID Volume on your unit when you perform the setup procedure.

The benefits of a RAID can include:

- Higher data transfer rates for increased server performance
- Increased overall storage capacity for a single Volume
- Data redundancy/fault tolerance for ensuring continuous system operation in the event of a disk drive failure

Different RAID levels use different organizational models and have varying benefits. The following outline breaks down the properties for each RAID level supported on this unit:

RAID 0 – Stripe

When a RAID Volume is striped, the read and write blocks of data are interleaved between the sectors of multiple disk drives. Performance is increased, since the workload is balanced between drives or “members” that form the RAID Volume. Identical drives are recommended for performance as well as data storage efficiency.

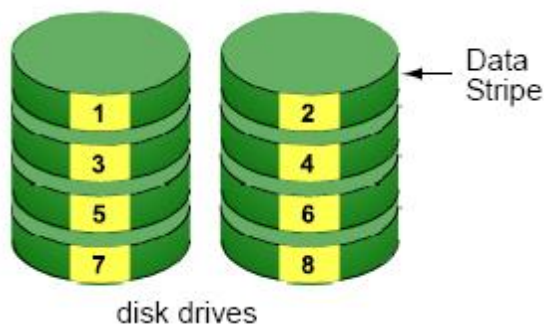

The RAID Volume’s data capacity equals the capacity of the smallest disk drive times the number of disk drives. For example, one 100 GB and three 120 GB drives will form a 400 GB (4 x 100 GB) RAID Volume instead of 460 GB.

If disk drives of different capacities are used, there will also be unused capacity on the larger drives.

Because RAID 0 does not offer Fault Tolerance, meaning that you cannot recover your data after a disk drive failure, we do not recommend a RAID 0 Volume for your unit.

RAID 0 Volumes on this unit consist of one or more disk drives.

RAID 1 – Mirror

When a RAID Volume is mirrored, identical data is written to a pair of disk drives, while reads are performed in parallel. The reads are performed using elevator seek and load balancing techniques where the workload is distributed in the most efficient manner. Whichever drive is not busy and is positioned closer to the data will be accessed first.

With RAID 1, if one disk drive fails or has errors, the other mirrored disk drive continues to function. This is called Fault Tolerance. Moreover, if a spare disk drive is present, the spare drive will be used as the replacement drive and data will begin to be mirrored to it from the remaining good drive.



The RAID Volume's data capacity equals the smaller disk drive. For example, a 100 GB disk drive and a 120 GB disk drive have a combined capacity of 100 GB in a mirrored RAID Volume.

If disk drives of different capacities are used, there will also be unused capacity on the larger drive.

RAID 1 Volumes on this unit consist of two disk drives.

If you want a mirrored RAID Volume with more than two disk drives, see **RAID 10 – Mirror / Stripe** for details.

RAID 5 – Block Striping with Distributed Parity

RAID 5 organizes block data and parity data across the disk drives. Generally, RAID level 5 tends to exhibit lower random write performance due to the heavy workload of parity recalculation for each I/O. RAID 5 works well for file, database, application and web servers.

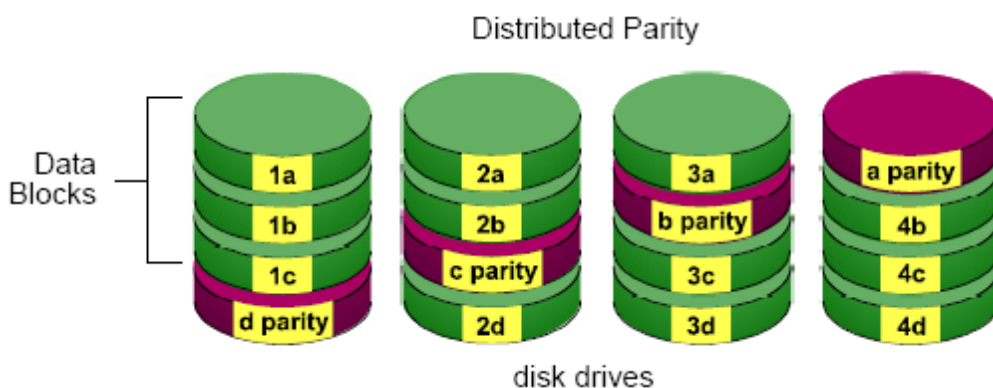

The capacity of a RAID 5 Volume equals the smallest disk drive times the number of disk drives, minus one. Hence, a RAID 5 Volume with four 100 GB disk drives will have a capacity of 300 GB. A RAID Volume with two 120 GB disk drives and one 100 GB disk drive will have a capacity of 200 GB.

RAID 5 is generally considered to be the most versatile RAID level.

RAID 5 requires a minimum of three disk drives.

RAID 10 – Mirror / Stripe

Mirror/Stripe combines both of the RAID 0 and RAID 1 types. RAID 10 can increase performance by reading and writing data in parallel while protecting data with duplication. At least four disk drives are needed for RAID 10 to be installed. With a four-disk-drive RAID Volume, one drive pair is mirrored together then striped over a second drive pair.

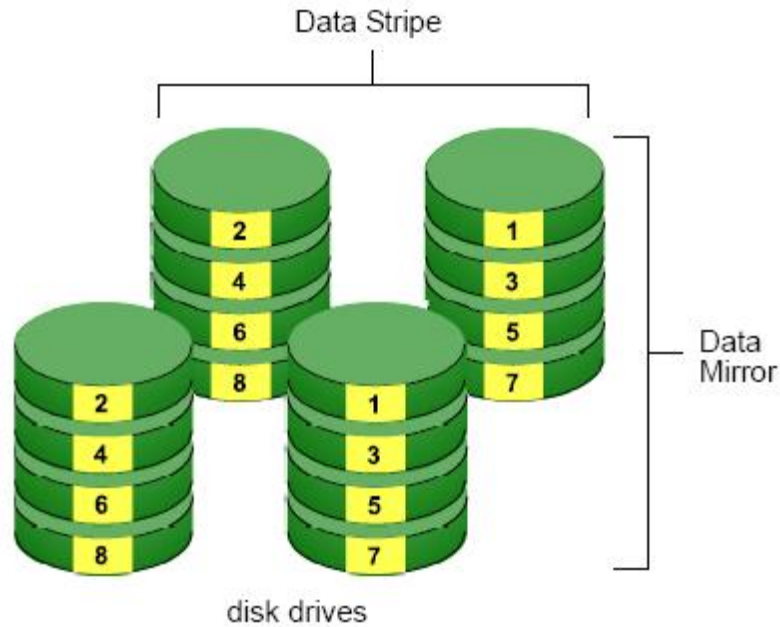

The data capacity RAID 10 Volume equals the capacity of the smallest disk drive times the number of disk drives, divided by two.

In some cases, RAID 10 offers double fault tolerance, depending on which disk drives fail.

RAID 10 Volumes on this unit consist of four disk drives.

Because all of the available disk drives are used for the RAID Volume, you cannot set up a spare drive with RAID 10.

Choosing a RAID Level

There are several issues to consider when choosing the RAID level. The following summarizes some advantages, disadvantages and applications for each choice.

- **RAID 0**

Advantage	Disadvantage
<ul style="list-style-type: none"> ● Implements a striped disk RAID Volume, the data is broken down into blocks and each block is written to a separate disk drive ● I/O performance is greatly 	<ul style="list-style-type: none"> ● Not a true RAID because it is not fault tolerant ● The failure of just one drive will result in all data in a RAID Volume

<p>improved by spreading the I/O load across many channels and drives</p> <ul style="list-style-type: none"> ● No parity calculation overhead is involved 	<p>being lost</p> <ul style="list-style-type: none"> ● Should not be used in mission critical environments
--	---

- **RAID 1**

Advantage	Disadvantage
<ul style="list-style-type: none"> ● Simplest RAID storage subsystem design ● Can increase read performance by processing data requests in parallel since the same data resides on two different drives 	<ul style="list-style-type: none"> ● Very high disk overhead - uses only 50% of total capacity

- **RAID 5**

Advantage	Disadvantage
<ul style="list-style-type: none"> ● High Read data transaction rate ● Medium Write data transaction rate ● Good aggregate transfer rate ● Most versatile RAID level 	<ul style="list-style-type: none"> ● Disk failure has a medium impact on throughput

- **RAID 10**

Advantage	Disadvantage
<ul style="list-style-type: none"> ● Implemented as a mirrored RAID ● Volume whose segments are RAID 0 RAID Volumes ● High I/O rates are achieved thanks to multiple stripe segments 	<ul style="list-style-type: none"> ● Very high disk overhead – uses only 50% of total capacity