



The Intelligent Surveillance Solution

NVRsolo
User Manual (Local)

Ver. 3.1.0

Table of Contents

1	Introduction	4
2	Tour the Unit	5
2.1	Front View (1 Bay/2 Bay Unit).....	5
2.2	Rear View (1 Bay/2 Bay Unit).....	6
2.3	Front View (8 Bay Unit).....	8
2.4	Rear View (8 Bay Unit).....	11
3	Set up the Unit	12
3.1	Unpack the Unit.....	12
3.2	Install Hard Drives.....	12
3.2.1	1 bay unit: install 3.5" HDD.....	13
3.2.2	1 bay unit: install 2.5" HDD.....	13
3.2.3	2 bay unit: Install 3.5" HDD	14
3.2.4	8 bay unit: install 3.5" HDD.....	14
3.3	Connect the Unit and Devices within the Network	15
3.4	Connect the Monitor.....	15
3.5	Power on.....	15
4	First Power-on.....	16
4.1	Install Wizard.....	17
5	User Interface	24
5.1	Live View.....	25
5.1.1	Video Area	26
5.1.2	Status Bar.....	29
5.2	Playback.....	31
5.2.1	Video Area	32
5.2.2	Status Bar.....	34
6	Settings	37
6.1	Camera	39
6.1.1	Camera Settings	40
6.1.2	Batch Maintenance.....	50
6.1.3	Camera Status.....	54
6.2	Recording & Event	58
6.2.1	Recording Settings	59
6.2.2	Event & Action.....	67
6.2.3	Email.....	77
6.2.4	FTP Settings.....	82
6.3	Device.....	84

6.3.1	I/O Box Settings	85
6.3.2	I/O Pin Settings	88
6.4	Storage	92
6.4.1	RAID Management	93
6.4.2	Auto Backup	105
6.5	Network	107
6.5.1	Network Settings	109
6.5.2	Network Service	116
6.5.3	ezNUUO Registration	119
6.6	Management	123
6.6.1	User Management	124
6.6.2	License Management	131
6.6.3	Log System	138
6.6.4	Save/Load Configuration	143
6.7	System	149
6.7.1	Information	150
6.7.2	System Settings	152
6.7.3	System Upgrade	160
6.7.4	Install Wizard	165
6.8	Display	167
6.8.1	Monitor Settings	168
6.8.2	Display Settings	170
7	IR Remote Control	179
8	Appendix – RAID System	183
1.	Introduction to RAID	183
2.	RAID 0 – Stripe	183
3.	RAID 1 – Mirror	184
4.	RAID 5 – Block Striping with Distributed Parity	185
5.	RAID 10 – Mirror / Stripe	185
6.	Choosing a RAID Level	186
9	Appendix – Camera Integration	187
7.	Camera Support List	187

GNU General Public License

This product includes copyrighted third-party software licensed under the terms of the GNU General Public License. Please see the GNU General Public License (GPL) for the exact terms and conditions of this license at **www.gnu.org**. The GPL source code incorporated into the product is available for free download at our web site **<http://www.nuuo.com/>**.

Subject to GPL, you may re-use, re-distribute and modify the GPL source code.

Note that with respect solely to the GPL Software, no warranty is provided. We do not offer direct support for the distribution.

1 Introduction

NVRsolo is a Linux-embedded stand-alone system, providing a stable and good quality local display through HDMI or VGA interface. As a network-based surveillance system, NVRsolo processes remote access ability to strengthen its usability.

NVRsolo is compatible with more than 80 brands of IP cameras, with monthly free pack update. It features two useful functions, one-click setup and ezNUUO. One-click setup saves the time in camera configuration by searching and automatically adding cameras in the system. ezNUUO facilitates the process of establishing Internet access to the NVRsolo system, meaning there is no more router settings for remote (IE 8, 9, 10, 11) and mobile viewing (iPhone, iPad, Android).

Being consistent with all the systems in NUUO Mainconsole family, NVRsolo is compatible with NUUO Central Management System, making it appropriate not only for home or SMB recording, but also for chain stores or ATM/bank projects by POS support.

This user's manual encompasses the information users need to set up and configure the system. It is recommended that you keep one copy of this manual for any necessary reference in the future.

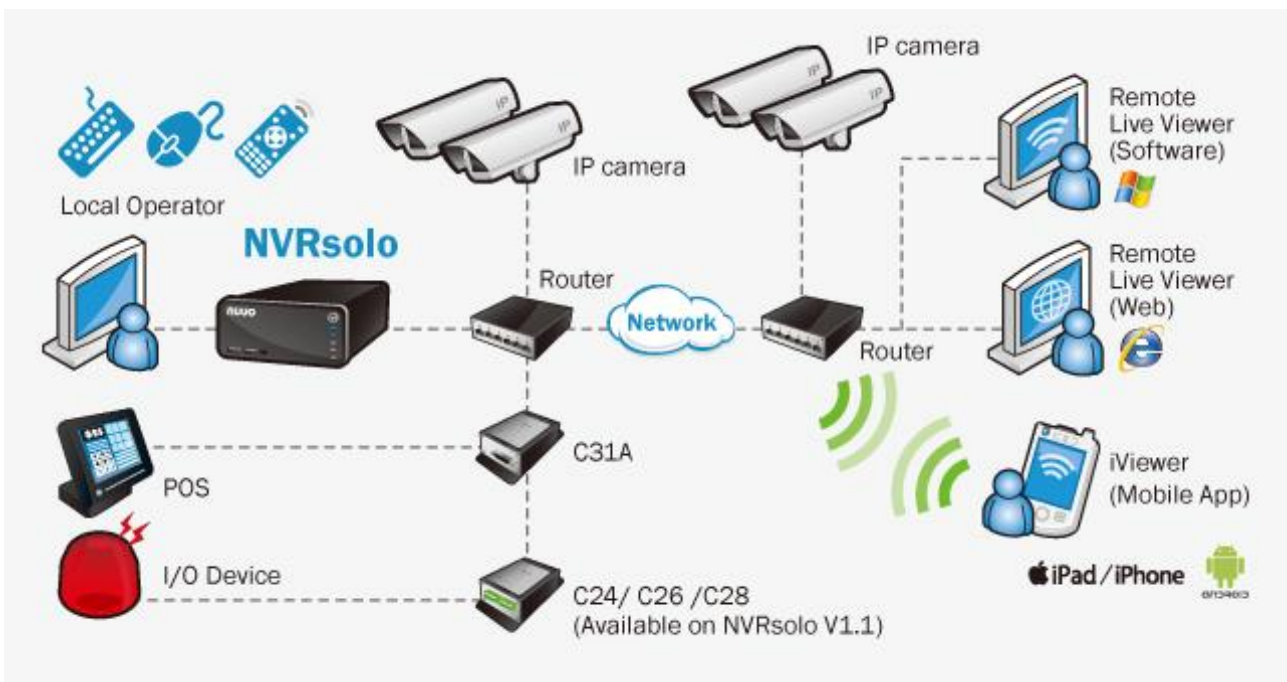

2 Tour the Unit

Before the unit takes part in your work, get to know it first. This section will walk you through the components and I/O ports and help you set the unit to work.

2.1 Front View (1 Bay/2 Bay Unit)

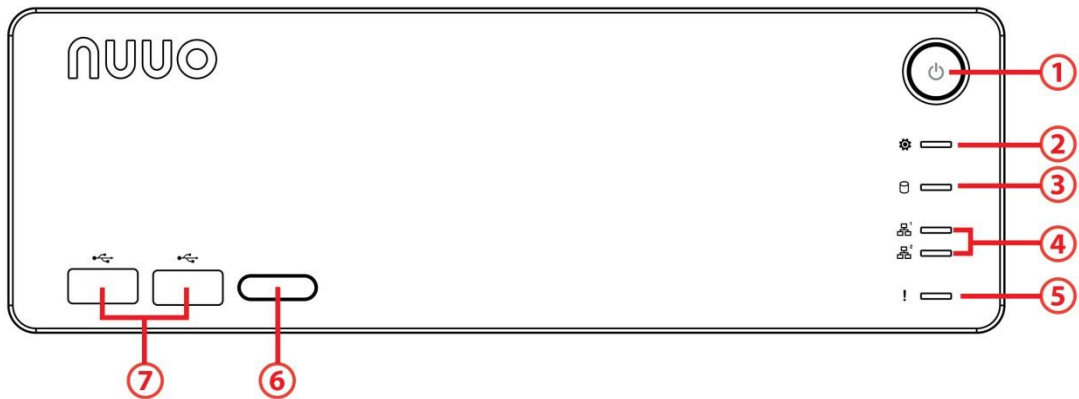

Status LED:

No.	Description	Status Notice	Remark
1	Power Status LED	<ul style="list-style-type: none"> ▶ Power-on: blue ▶ Power-off: dark 	--
2	System Status LED	<ul style="list-style-type: none"> ▶ Healthy: blue ▶ Unhealthy: orange ▶ Abnormal temperature status: orange with blinking ▶ Off: dark 	1) Orange: System or RAID is abnormal 2) Orange with blinking: CPU temperature/fan rpm is beyond the normal range 3) Blinking (200 ms On/ 200 ms Off)
3	HDD Status LED	<ul style="list-style-type: none"> ▶ Healthy: blue ▶ Failed: orange ▶ No disk: dark ▶ Rebuilding: orange with blinking 	1) LED for all disks 2) Blinking (200 ms On/ 200 ms Off)
4	Ethernet Status LED	<ul style="list-style-type: none"> ▶ Linking: blue ▶ Accessing: blue with blinking ▶ No linking: dark 	1) LED for Ethernet port (1*output for detecting connection status of switch) 2) Blinking (200 ms On/ 200 ms Off)
5	Alarm LED	<ul style="list-style-type: none"> ▶ No event happened: dark ▶ Event detected: orange with blinking 	Blinking (200 ms On/ 200 ms Off)

External Control and I/O Ports:

No.	Description
1	Power button
6	Remote control IR receiver
7	USB 2.0 connector

2.2 Rear View (1 Bay/2 Bay Unit)

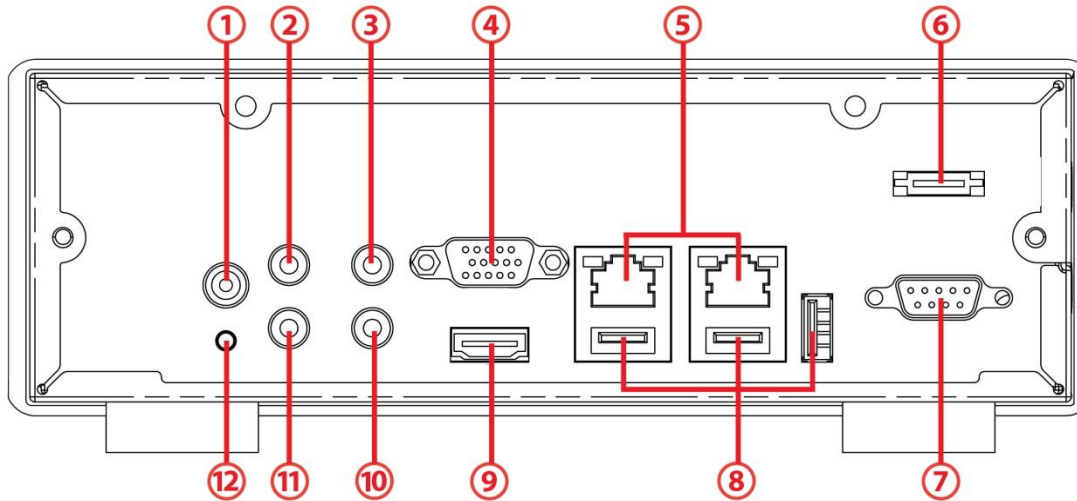

Status LED:

No.	Description	Status Notice	Remark
5	Ethernet Activity LED	<ul style="list-style-type: none"> ▶ Linking: green ▶ Accessing: green with blinking ▶ Not linked: dark 	1) LED for Ethernet port 2) Blinking (200 ms On/ 200 ms Off)

External Control and I/O Ports:

No.	Description
1	DC-in power connector
2	3.5 mm mic-in
3	3.5 mm audio out (headphone jack)
4	VGA connector
5	RJ-45 LAN ports 1 / 2
6	eSATA connector
7	COM port (RS-232 reserved)
8	USB 2.0 connectors
9	HDMI connector
10	Connection of IR extender
11	3.5 mm line-in
12	Reset toggle

Horizontal

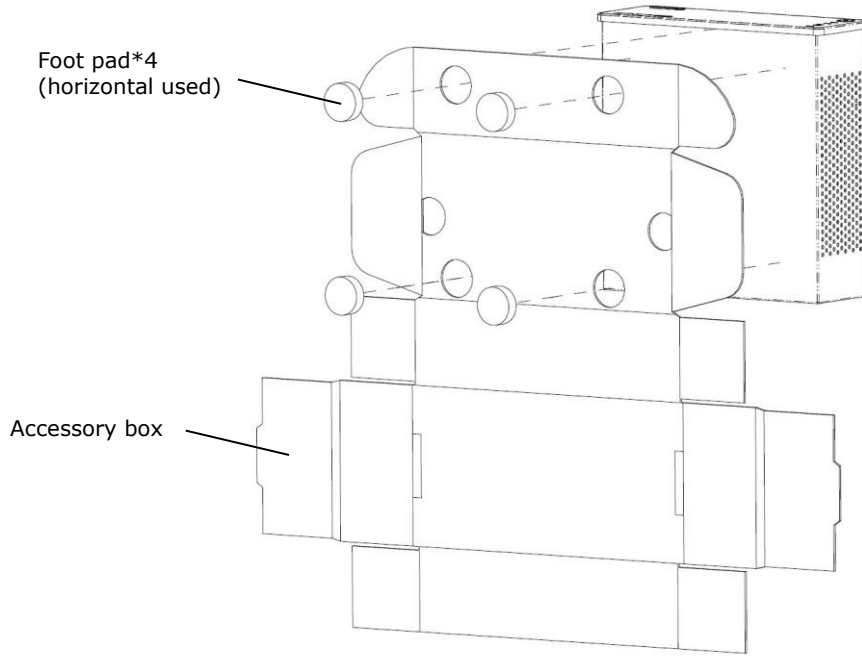

Vertical

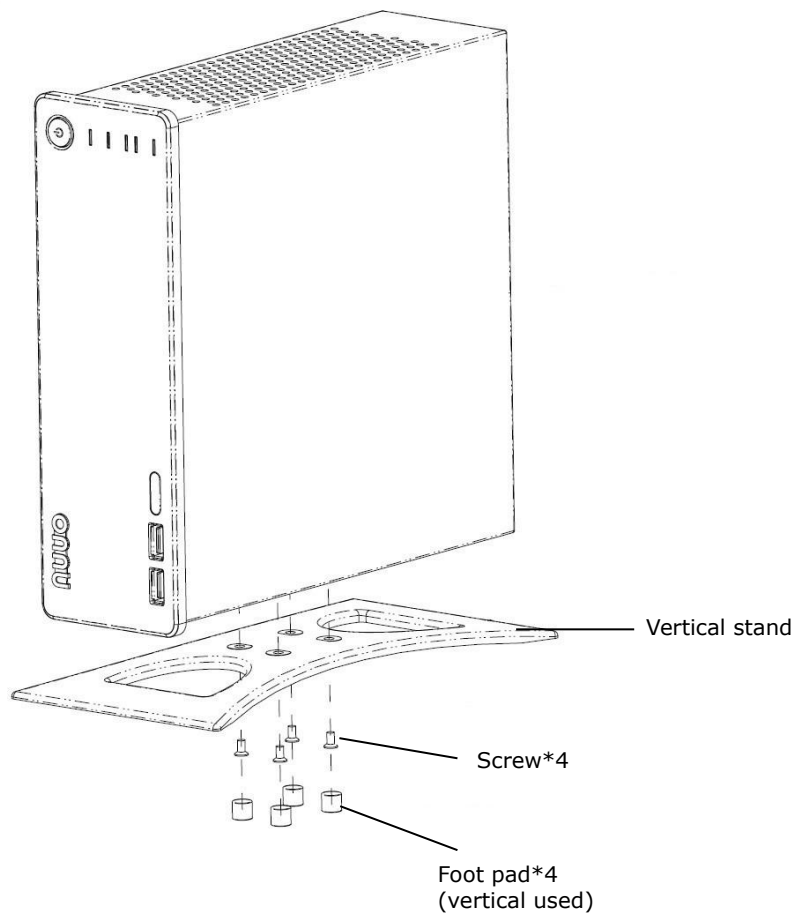

2.3 Front View (8 Bay Unit)

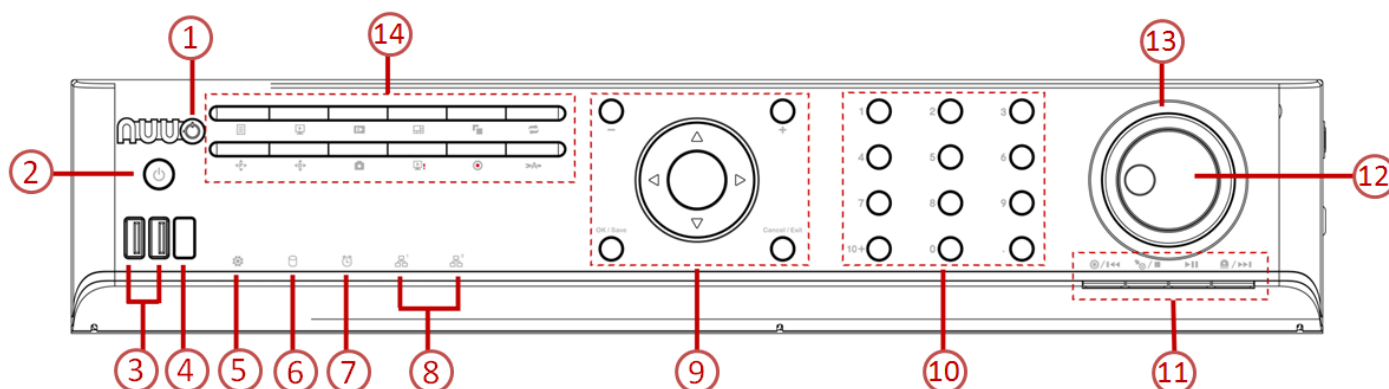





























Status LED:

No.	Description	Status Notice	Remark
1	Lock	<ul style="list-style-type: none"> ▶ The lid is locked when first unpacked. 	
2	Power Status LED	<ul style="list-style-type: none"> ▶ Power-on: blue ▶ Power-off: dark 	--
5	System Status LED	<ul style="list-style-type: none"> ▶ Healthy: blue ▶ Unhealthy: orange ▶ Abnormal temperature status: orange with blinking ▶ Off: dark 	<ol style="list-style-type: none"> 1) Orange: System is abnormal (including RAID) 2) Orange with blinking: CPU temperature/fan rpm is beyond the normal range 3) Blinking (200 ms On/ 200 ms Off)
6	HDD Status LED	<ul style="list-style-type: none"> ▶ Healthy: blue ▶ Failed: orange ▶ No disk: dark ▶ Rebuilding: orange with blinking 	<ol style="list-style-type: none"> 1) LED for all disks 2) Blinking (200 ms On/ 200 ms Off)
7	Alarm LED	<ul style="list-style-type: none"> ▶ No event happened: dark ▶ Event detected: orange with blinking 	Blinking (200 ms On/ 200 ms Off)
8	Ethernet Status LED	<ul style="list-style-type: none"> ▶ Linking: blue ▶ Accessing: blue with blinking ▶ No linking: dark 	<ol style="list-style-type: none"> 1) LED for Ethernet port (1*output for detecting connection status of switch) 2) Blinking (200 ms On/ 200 ms Off)

External Control and I/O Ports:

No.	Description
1	Lock
2	Power button

3	USB 2.0 connector	
4	Remote control IR receiver	
9	Plus (+) and Minus (-) keys	<ol style="list-style-type: none"> Moves between the eight Menus under the Main Menu, i.e. hit these keys to navigate between these menus:  Moves between the available tabs featured by a submenu. Flips up and down the page.
	OK / Save key	<p>This key delivers the same function as clicking the OK or Save button on a tab or dialog. Its functions include:</p> <ul style="list-style-type: none"> ▶ Quitting a tab saving the change(s). ▶ Applying the change(s) made on a tab
	Cancel / Exit key	<p>This key delivers the same function as clicking the Exit or Cancel button on a tab or dialog. Its functions include:</p> <ul style="list-style-type: none"> ▶ Quitting a tab without saving the change(s). ▶ Closing a dialog or a tab.
	 Enter / Home	<ul style="list-style-type: none"> ▶ As the Enter key, it makes a selection (check box, radio button or a selectable item, i.e. the highlight item) onscreen or confirms input. ▶ As the Home key, it turns the video of the focused channel to the preset Home point. ▶ Hit this key to a selected Video Area to maximize it to full screen. Hit it again to resize the Video Area. See also Video Area and Video Area.
	 Left/Right arrow keys	<p>These keys can be hit to move left and right between the menus of the Main Menu and the highlighted items on all setting pages.</p>
	 Up/Down arrow keys	<p>These keys can be hit to move up and down between the submenus of a menu and the highlighted items on all setting pages.</p>
10	<p>Numeric keypad</p> 	<p>Enters numeric characters, or selects a video channel. Examples: Press key 1 to select video channel 1. Press keys 10+ and 0 to select video channel 10.</p> <ul style="list-style-type: none"> ▶ The timeout for 10+ key is 5 seconds. ▶ Keystroke timeout is applicable to 10+ key only.
11	 Preset Set	<p>Opens a panel to set or deletes a preset point.</p> <ul style="list-style-type: none"> ▶ Only one point can be set or deleted at one time. ▶ The panel auto closes after the setting or deletion is done. Or hit the key once again to close the panel. ▶ This key is only applicable to the Live View screen.
	 Preset Go	<p>Opens a small panel to jump to the desired preset point or to start/stop patrol.</p> <ul style="list-style-type: none"> ▶ The panel auto closes once the action is launched. Hitting the key once again also closes the panel. ▶ This key is only applicable to the Live View screen.
	 I/O	<p>Opens a list of the available camera I/O pins.</p> <ul style="list-style-type: none"> ▶ This key is only applicable to the Live View screen.
	 Play / Pause	<p>Delivers different functions in Live View and Playback.</p> <ul style="list-style-type: none"> ▶ Live View: Starts the Instant Playback ▶ Playback: Starts or halts the playing.
	 Stop	<p>Stops playing.</p> <ul style="list-style-type: none"> ▶ This key is only applicable to the Playback screen. ▶ The playback stops by showing the frame where the video starts. ▶ Whether the video is being fast-forwarded or reverse-played at the moment, press Stop key will restore the playback speed to x1.
	 Previous	<p>Hit this key once to bring the playback to the previous interval.</p> <ul style="list-style-type: none"> ▶ See Playback to know how to set Playback Interval.

	Interval	
	 Next Interval	Hit this key once to jump the playback to the next interval. ▶ See Playback to know how to set Playback Interval .
12	 Step Backward	Hit this key once to bring the playback to the previous frame.
	 Step Forward	Hit this key once to jump the playback to the next frame.
13	 Fast-Forward	Hit once to fast-forward the playback with x2 speed. Hit twice to fast-forward the playback to x4 speed. Increment the fast-forwarding speed by increasing your keystrokes. When the fast-forwarding speed is incremented to x16, it auto-restores to x1 speed. ▶ This key is only applicable to the Playback screen.
	 Rewind	Hit once to rewind with x-1 speed. Hit twice to rewind with x-2 speed. Taper the rewinding speed by increasing your keystrokes. When the rewinding speed is tapered to x-16, it auto-restores to x-1 speed. ▶ This key is only applicable to the Playback screen.
14	 Menu	Opens the system's Main Menu . ▶ See Settings to know all the settings featured by the Main Menu . ▶ This key is only applicable to Live View screen.
	 Live View	Switches the screen to Live View .
	 Playback	Switches the screen to Playback and opens the Search dialog.
	 Layout	Switches between different layouts of video channels on the Video Areas . See also Video Area and Video Area .
	 Group	Switches the screen to the next camera group. ▶ This key is only applicable to the Live View screen.
	 Auto Scan	Hit to apply Auto Scan . ▶ See Display for the details about Auto Scan . ▶ Hit again to quit Auto Scan . ▶ Pressing Group , Snapshot , DPTZ , PPTZ , Preset or Go to Preset key will disable Auto Scan . ▶ This key is only applicable to the Live View screen.
	 P PTZ	Opens the physical PTZ panel for PTZ operation. ▶ Hit this key again to close the physical PTZ panel. ▶ This key is only applicable to the Live View screen.
	 D PTZ	Opens the digital PTZ panel for PTZ operation. ▶ Hit this key again to close the digital PTZ panel.
	 Snapshot	Opens a dialog to capture the current screen. ▶ Press Save button to save the screenshot; or press Cancel button to quit without capture.
	 Event	Checks the recent events and notifications. ▶ This key is only applicable to the Live View screen.
	 Emergency Record	Enables/disables Always record . ▶ See also Mode tab for more details about the recording modes. ▶ This key is only applicable to the Live View screen.
	 Auto Setup	Runs auto camera setup. ▶ This key is only applicable to the Live View screen.

2.4 Rear View (8 Bay Unit)

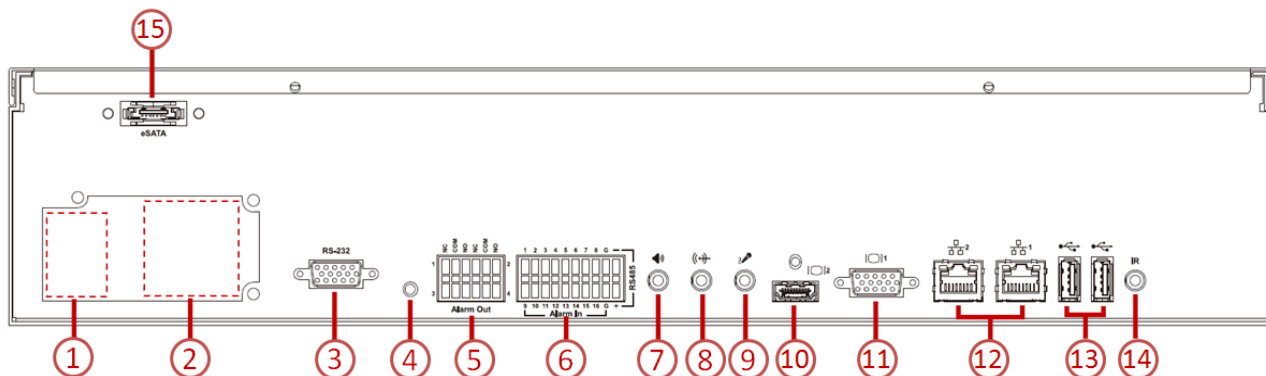

Status LED:

No.	Description	Status Notice	Remark
12	Ethernet Activity LED	<ul style="list-style-type: none"> ▶ Linking: green ▶ Accessing: green with blinking ▶ No linking: dark 	3) LED for Ethernet port 4) Blinking (200 ms On/ 200 ms Off)

External Control and I/O Ports:

No.	Description
1	Power cord connector
2	Cooling fan
3	COM port (RS-232 reserved)
4	Reset toggle
5	Relay output*4, support N.O. / N.C. 3A, 24 VDC/ 120 VAC max
6	Digital input*16, dry contact
7	3.5 mm audio out (headphone jack)
8	3.5 mm line-in
9	3.5 mm mic-in
10	HDMI connector
11	VGA connector
12	RJ-45 LAN ports 1 / 2
13	USB 2.0 connectors
14	Connection of IR extender
15	eSATA connector

3 Set up the Unit

Set up the unit by installing the hard drive(s), connecting to network and power supply.

3.1 Unpack the Unit

This package contains the following items:

	1bay Package	2bay Package	8bay Package
The unit	✓	✓	✓
Remote control, 1.5M IR extender cable	✓	✓	✓
Disk screws	✓ (for 2.5" and 3.5" disk)	✓ (for 2.5" and 3.5" disk)	✓ (for 3.5" disk)
Pad and stand	[Horizontal] foot pads; [Vertical] Stand, foot pads and screws	[Horizontal] foot pads; [Vertical] Stand, foot pads and screws	Foot pads
Power	12V 4A 48W power adapter, power cord	12V 5A 60W power adapter, power cord	Power cord
Warranty card, Quick Start Guide, CD	✓	✓	✓
Rackmount kit, screws	-	-	✓
Key	-	-	✓

*CD content: **Install Wizard, Remote Live Viewer, Playback System, Backup System, Verification Tool** and **Offline License Tool** application, user manual, and quick start guide



Battery spec is 1.5V, AAA, R03. Two batteries are required for a remote control.

*Caution: Risk of Explosion if Battery is replaced by an Incorrect Type .Dispose of Used Batteries According to the instruction.

3.2 Install Hard Drives

Refer to compatibility list and install HDDs. For optimal performance consideration, install disks with the same model and storage capacity. The available RAID level depends on the amount of disks installed.

3.2.1 1 bay unit: install 3.5" HDD

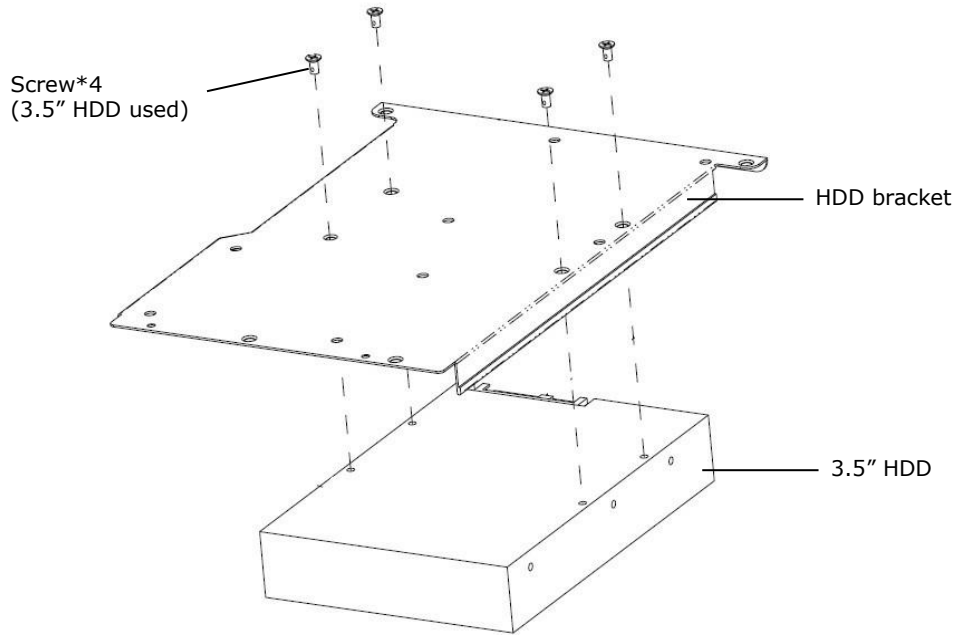

3.2.2 1 bay unit: install 2.5" HDD

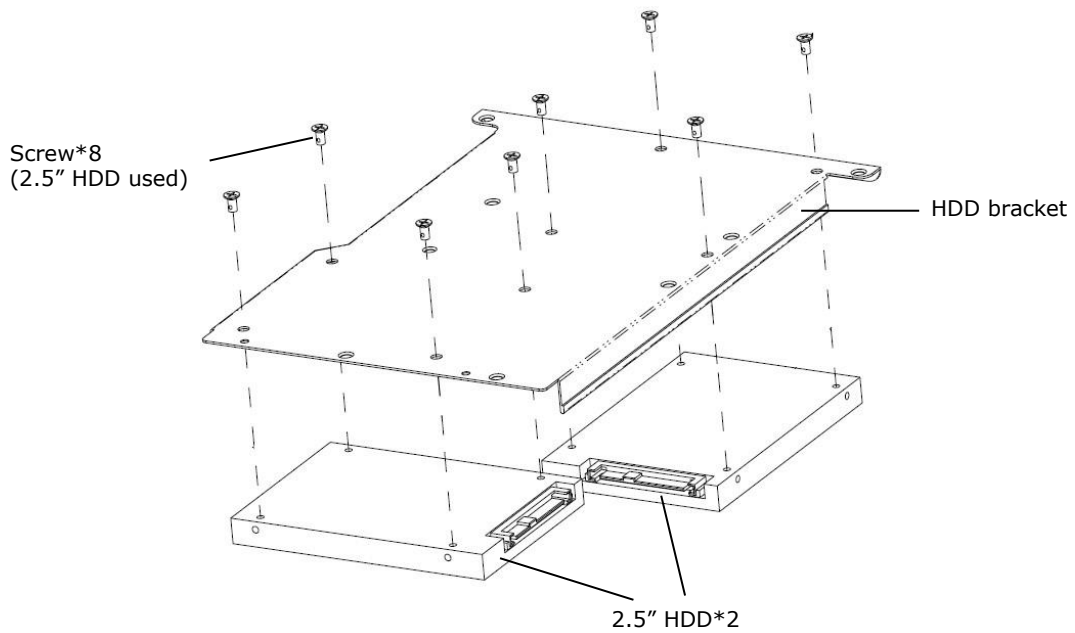

When installing HDDs on HDD bracket, please beware of sharp edges.

3.2.3 2 bay unit: Install 3.5" HDD

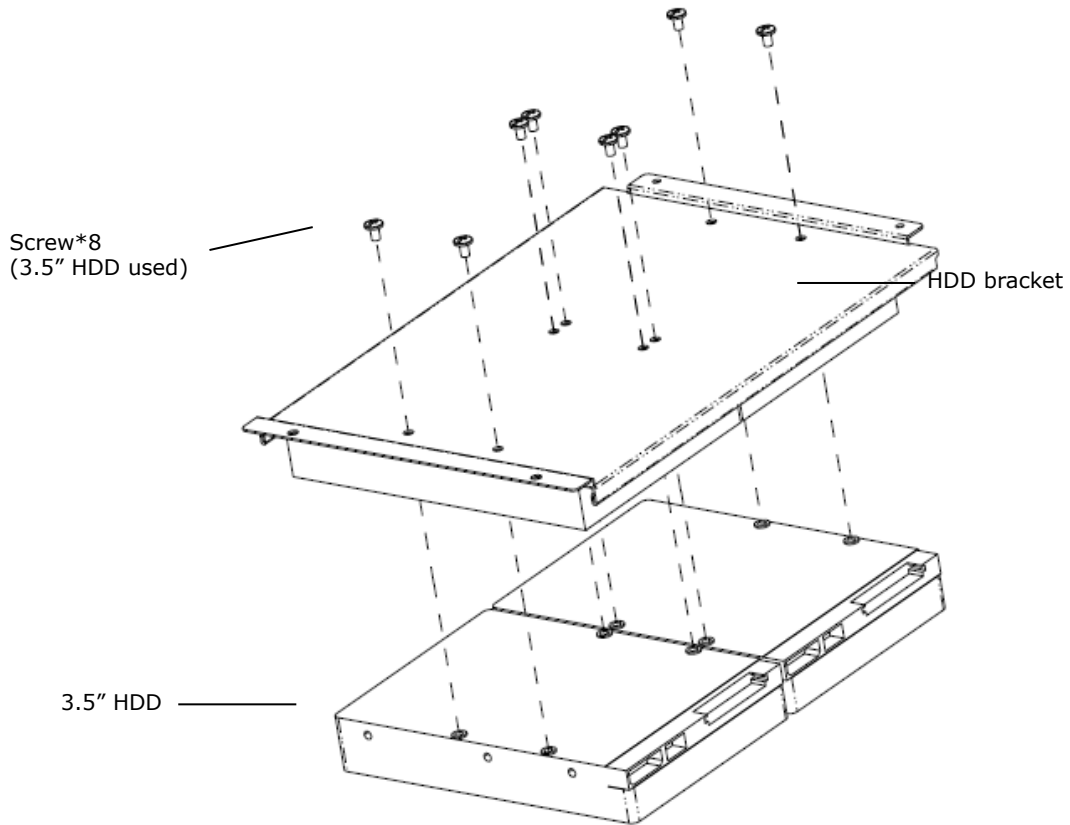

- For 2-bay installation, it is recommended to connect the SATA cable to HDDs before securing the HDDs to the bracket.
- When installing HDDs on HDD bracket, please beware of sharp edges.

3.2.4 8 bay unit: install 3.5" HDD

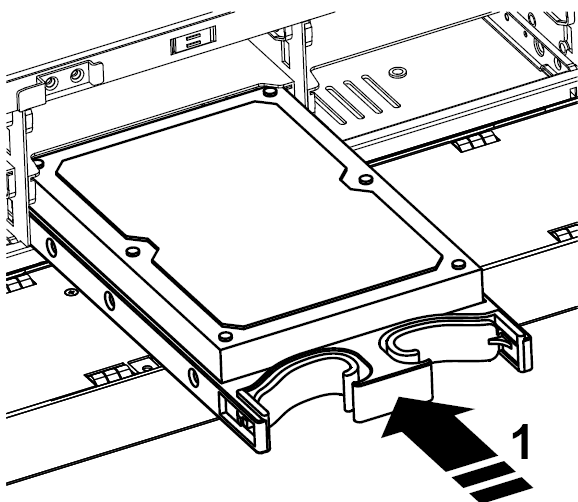

Insert

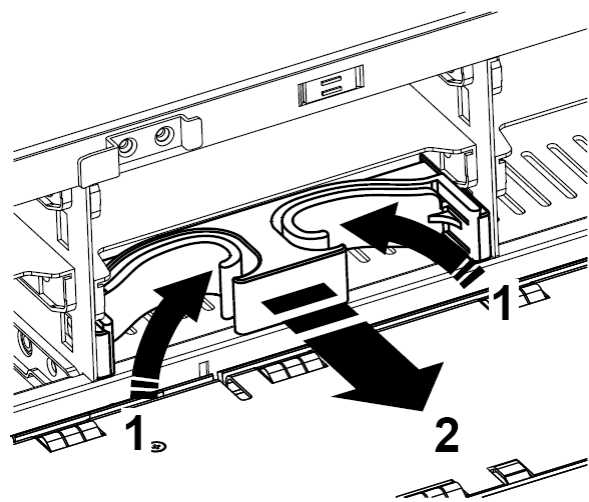

Pull out

3.3 Connect the Unit and Devices within the Network

Connect the unit, cameras, and router/switch. If you need to make the video visible over the Internet, please connect to a “router” with Internet connection, and the unit will retrieve an IP address through DHCP by default.



The unit processes built-in DHCP service, which takes the job of router to assign IP addresses, which is suitable for the pure LAN environment.

3.4 Connect the Monitor

The unit processes two display interfaces, VGA and HDMI. Connect the monitor to the unit.



The supporting display resolutions are 1920x1080, 1280x1024, 1280x720, and 1024x768. Please confirm that one of the resolution is supported by your monitor.

3.5 Power on

For 1bay/2bay unit, attach the power cord from the power source to the power adapter. Connect the power adapter to the back of the unit enclosure. For 8bay unit, connect the power cord directly to the back of the unit. See the rear view figure.

Press the power button once connecting the power. See the front view figure.

It takes about a minute for the unit to fully power up. Once it is powered up:

- The System Status LED turns blue
- The buzzer beeps one time

To power off the unit, press and hold the power button for 2 seconds until two beeps are heard. The system will proceed to shut down once the button is released.



If the system crashes or stops responding, press and hold the power button for 10 seconds to enforce hardware power-off, which turns off the computer by cutting off the power directly. Hence, such power-off isn't recommended for a system that is working properly.

4 First Power-on

To power on the unit, press the power button on the front panel. The unit will sound a beep and powers on.

When the system starts up for the first time, it asks users to select the language to use in the system. Then the system will restart again to apply the selected language.



Language can also be changed later in **Main Menu > System menu > System Settings** submenu > **General** tab

Right after the restart, the system will trigger the **Install Wizard**, which will lead through some basic settings of the operating system.

4.1 Install Wizard



The **Install Wizard** opens featuring two modes:

Mode	Description
Express Mode	Features the quick setup of the unit including administrator password setup, online license activation, camera setup, system date/time setting and upgrade notification activation. <ul style="list-style-type: none">▶ Select this mode if you are not familiar with the network settings or not sure if your network includes a router.▶ Before proceeding with this mode, connect all the cables and cameras.
Advanced Mode	Features more settings than the Express Mode does by the additional DHCP server settings, network settings and RAID level setting.



All the settings featured by **Install Wizard** are accessible from the operating system's **Main Menu**, and thus can be skipped for makeshift.

1. Setup the password of administrator. If you want to keep the default as admin, click the **Next** button directly.



2. The unit possesses built-in DHCP service, which enables the system to dynamically assign IP addresses to the connected camera clients within the same subnet. When you have router in your network, we strongly recommend choosing **Always disable** to avoid any IP conflicts. If you are not sure if there is any router in your network, please choose **Smart enable**, which detects the network environment then decide to enable or disable the service. Click the **Next** button.



3. If you select **Smart enable** from the previous setup, there is at least one LAN has to be set as a static IP. Click the **Next** button.



4. Define the IP range for built-in DHCP server. The system will assign IP addresses based on the range you defined to devices. Click the **Next** button.

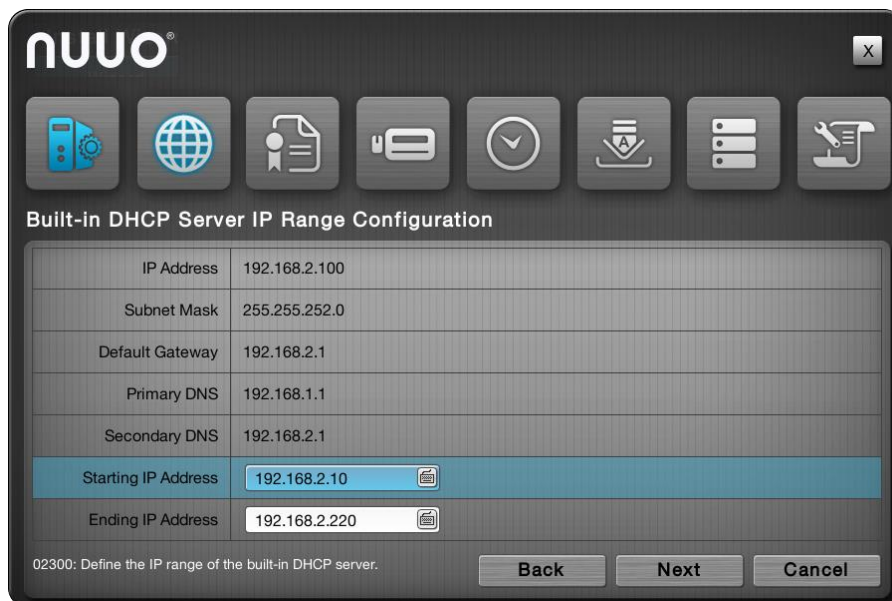

5. There are several base licenses differed by models. Activate camera license to have more channel capacity, and click the **Next** button.

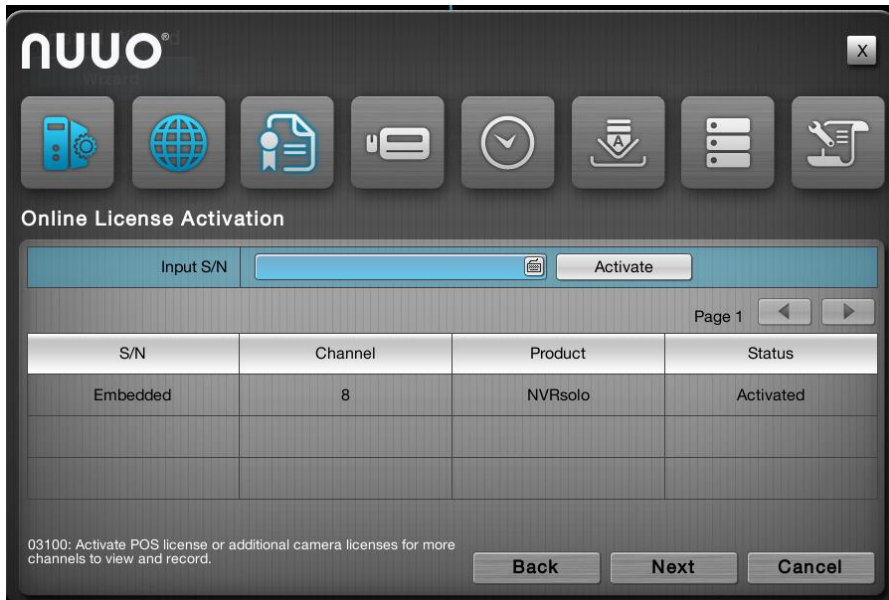

6. Click the **Setup** button to search and automatically add the cameras within the same subnet. Click the **Next** button.





- Set up the time zone, date, and time, and adjust daylight saving changes if needed. Once daylight saving function is enabled, the time change will activate automatically every year based on the recurrence you set. Click the **Next** button.



- Check "**Enable Upgrade Notification**" box if you want to receive notification when there is a newer FW version. Click the **Next** button. If you are using remote control to set up, you can press **+** button to quickly flip through the agreement.

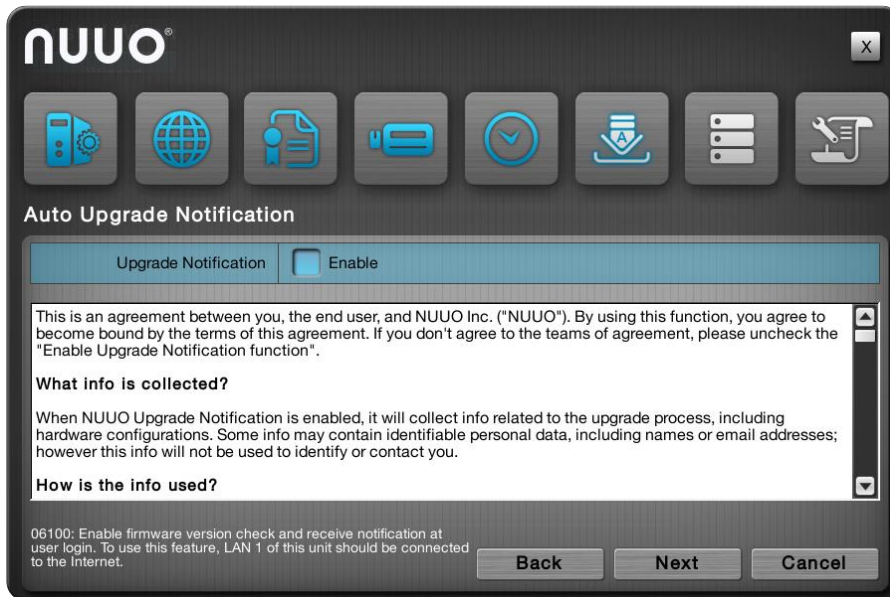

- Follow the following instruction and select the RAID type you want to create. If you have created a volume, you will see the information of this volume on the table as the picture below. Click the **Next** button.



 The available RAID level depends on the amount of disks installed.

- Review your settings. If the settings are correct, click the **Finish** button to exit the settings procedure and activate the system.



Once the preliminary setup is through, the system auto-restarts. Before the operating system opens onscreen, users are prompted to enter a username and password to log in the operating system. The username and password are both "admin" by default if you haven't provided an alternate password in the **Install Wizard**. (Username isn't changeable with **Install Wizard**.)

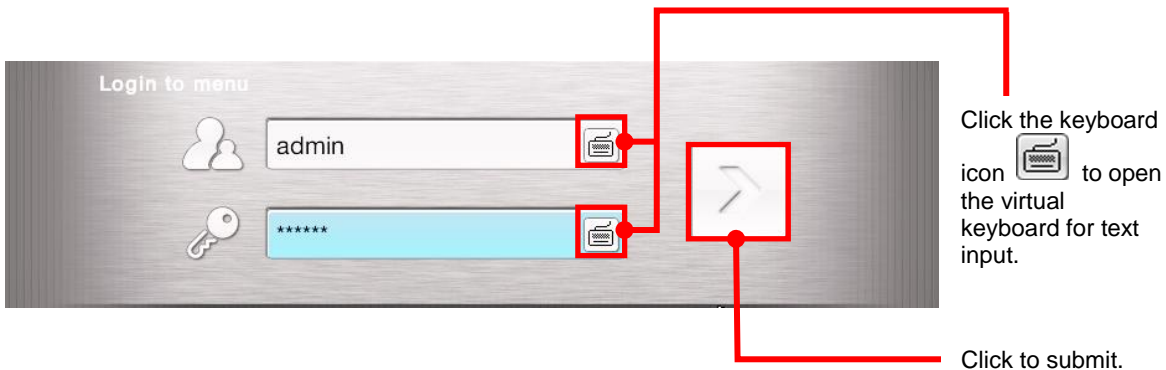

5 User Interface

The operating system presents its user interface in two major screens to deliver the service, one is the **Live View** screen; the other is **Playback** screen. The **Live View** screen shows the instant video(s) while the **Playback** screens plays the recorded videos. Both screens come with a horizontal bar baring a handful of clickable buttons to launch actions from the system and allow users to exert the system's functions. The following of this chapter will guide you through these two screens.

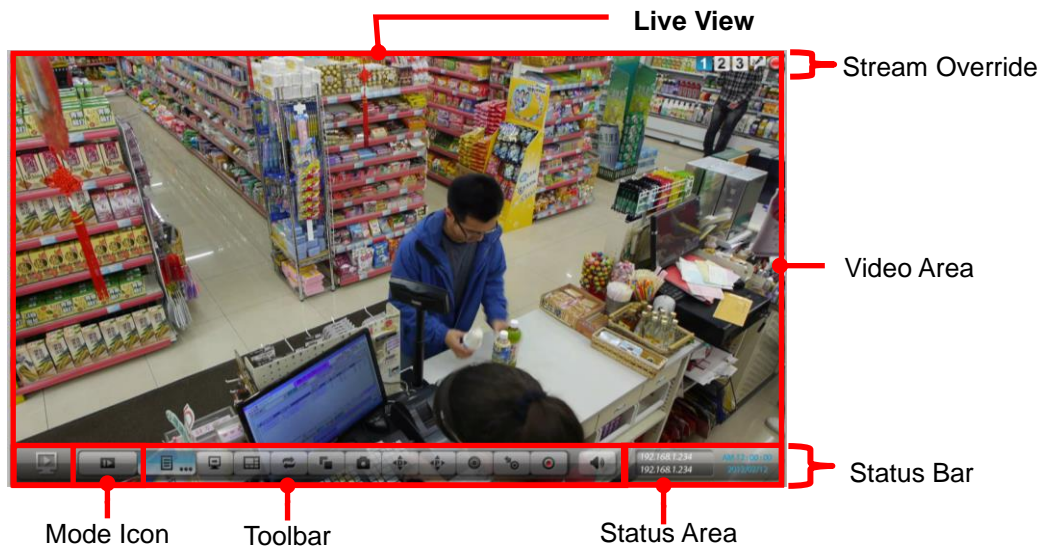

5.1 Live View

When the operating system starts and users log in, it is the **Live View** that opens onscreen. Exactly as its name communicates, the **Live View** is the screen where the instant videos are displayed. Most of the **Live View** screen is occupied by a predominant video area, with a horizontal and rectangular **Status Bar** spreading along the bottom of the screen. The following of this section will guide you through the **Live View's Status Bar**.

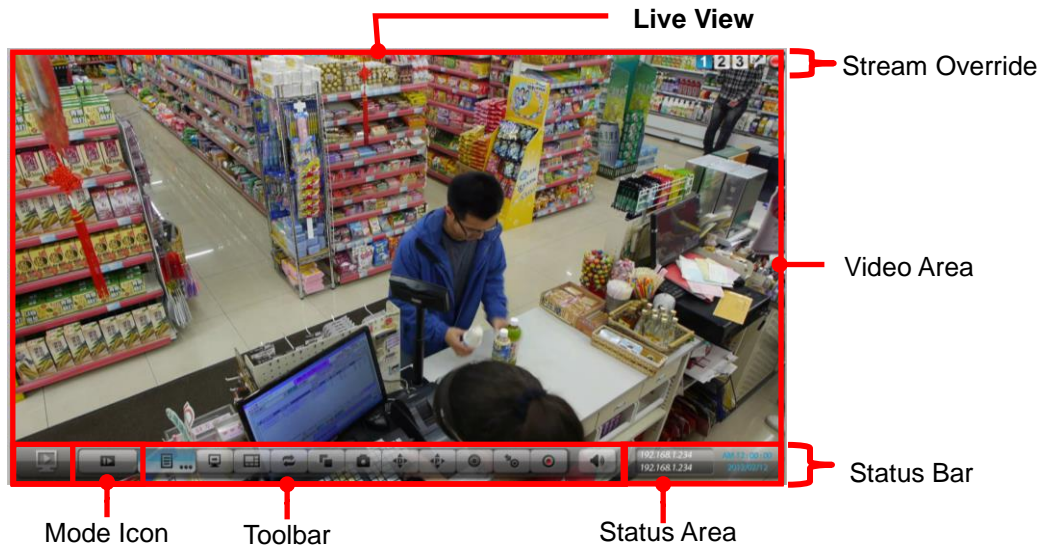

5.1.1 Video Area

If a camera is correctly set up and run, the **Live View's Video Area** auto-shows the subject scene that the camera takes; otherwise it shows a black screen with an  icon in the center.

The screenshot below shows the **Live View's Video Area** with the cameras correctly set up and run.

Configure camera multi-stream icons on the Live View screen to override current decoding streaming.

Enable two-way audio on the Live View screen.

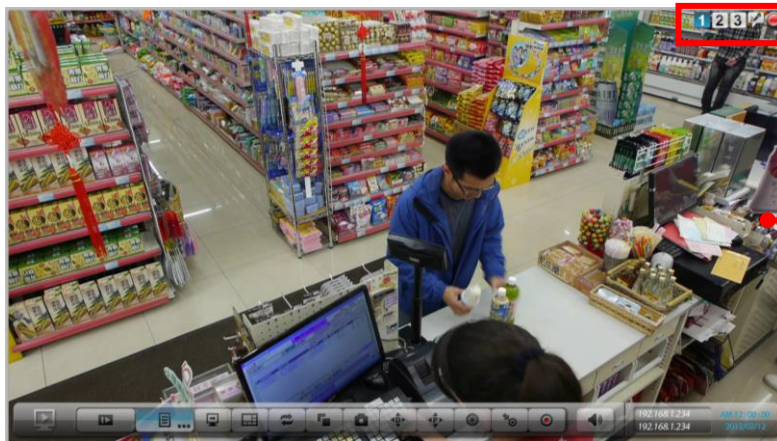

Stream Override, Talk on the Live View screen

Video Area on the Live View screen

The screenshot below, however, shows an abnormal **Video Area** of the **Live View** with a black screen having nothing but a "disconnection" icon  in the center.

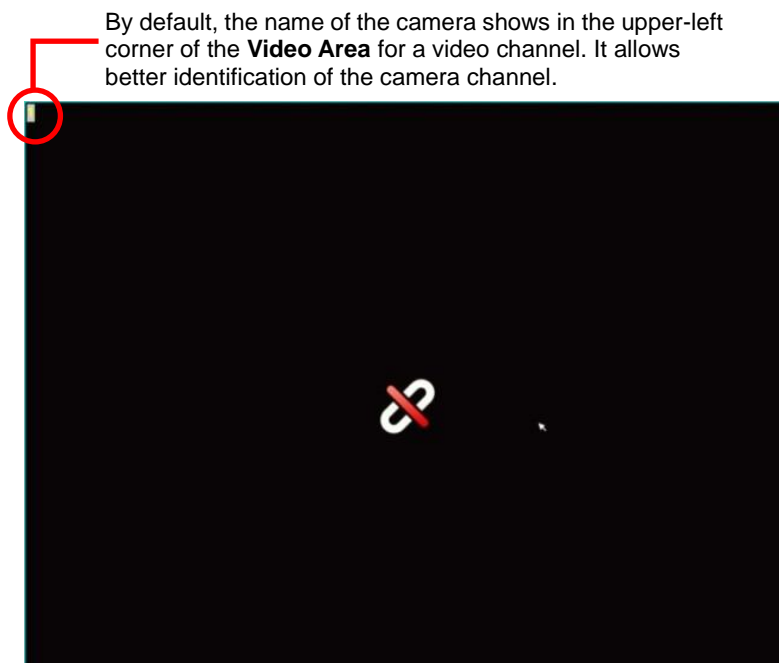

Video Area on the Live View screen

Icon	Name	Description
	Always Record	Recording status: always ▶ see Mode tab in Recording Setting submenu for more information
	Dual record -always record	The left signal represents 1st stream status, and the right signal represents 2nd stream status.
	Emergency Record	Recording status: emergency
	Motion Record	Recording status: camera motion triggers recording ▶ see Motion tab in Recording Setting submenu for more information
	Input Record	Recording status: input triggers recording ▶ see Input tab in Recording Setting submenu for more information
	Stream 1	Click to enable to decode stream 1 for the channel. ▶ See parameter tab in Camera Setting submenu for stream information. ▶ See Display tab in Display Settings submenu for more local decoding information.
	Stream 2	Click to enable to decode stream 1 for the channel. ▶ See parameter tab in Camera Setting submenu for stream information. ▶ See Display tab in Display Settings submenu for more local decoding information.
	Stream 3	Click to enable to decode stream 1 for the channel. ▶ See parameter tab in Camera Setting submenu for stream information. ▶ See Display tab in Display Settings submenu for more local decoding information.
	Talk	Click to enable two-way audio. ▶ Please insert the microphone properly before talking. ▶ Please switch to 1 st stream to receive the voice and sounds from camera. However, you may talk to camera side on every stream. ▶ See Rear View for installation.
	Disconnection	Disconnected camera
	Connecting	Connecting camera...
	No MxPEG	Video being played or recorded with MxPEG codec is currently supported on remote browser/application rather than on the local display.
<p>Out of resolution: Please set the cameras of which resolution are over 1920x1200</p>		<p>Video being played or recorded with high resolution is with limited support on local display, which is described as below.</p> <p>In firmware version 1.2 or above</p> <ul style="list-style-type: none"> ▶ H.264: no resolution limitation on single channel, the total capacity is around: <ul style="list-style-type: none"> - 8 channels: 5M / others: 2M - 6 channels: 8M / others: 2M *The actual performance depends on the type of cameras. ▶ MPEG4: Up to 2M (1920x1080) per channel ▶ MJPEG: Up to 4M (2560x1600) per channel but with

limited fps support

Before firmware version 1.2

- ▶ **H.264:** Up to 4M (2560x1600) per channel
- ▶ **MPEG4:** Up to 2M (1920x1080) per channel
- ▶ **MJPEG:** Up to 4M (2560x1600) per channel but with limited fps support



To configure how to present the **Video Area**, see [OSD](#).

To configure the **Multi-stream parameter**, see [parameter tab](#).

The microphone has to be inserted properly before talking. See [Rear View](#) for installation.

When using mouse, double-click on the **Video Area** of a video channel to maximize it to full screen. Double-click it again to resize it.

When using the **IR Remote Control**, hit the Enter key to maximize the **Video Area** of a video channel to full screen. And hit the Enter key again to resize it. See also [IR Remote Control](#).

5.1.2 Status Bar

The **Live View's Status Bar** is presented along the bottom of the screen. It comprises of three facilities, the **Toolbar**, **Status Area** and **Mode Icon**.

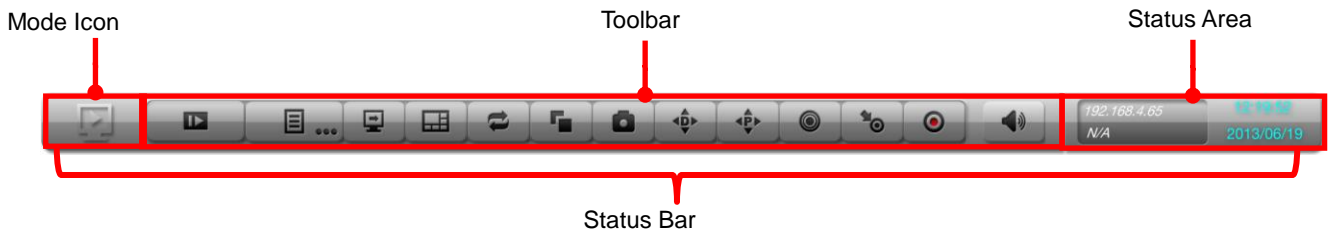







5.1.2.1 Toolbar

Settling between the **Mode Icon** and the **Status Area**, the **Toolbar on Live View** screen bears a handful of onscreen buttons. These buttons together enables configuring the system.



Button	Name	Description										
	Playback	Switches to Playback screen and opens the Search page that searches for recorded videos by the assigned date & time.										
	Menu List	<p>Opens a mini toolbar that covers the following buttons:</p> <table border="1"> <thead> <tr> <th>Button</th> <th>Description</th> </tr> </thead> <tbody> <tr> <td></td> <td>Opens the Main Menu of the operating system.</td> </tr> <tr> <td></td> <td>Opens the I/O Panel, which lists the available I/O pins of I/O devices.</td> </tr> <tr> <td></td> <td>Triggers Auto Camera Setup, which auto-searches and adds cameras to the system.</td> </tr> <tr> <td></td> <td>Logs out of the system.</td> </tr> </tbody> </table>	Button	Description		Opens the Main Menu of the operating system.		Opens the I/O Panel , which lists the available I/O pins of I/O devices.		Triggers Auto Camera Setup , which auto-searches and adds cameras to the system.		Logs out of the system.
Button	Description											
	Opens the Main Menu of the operating system.											
	Opens the I/O Panel , which lists the available I/O pins of I/O devices.											
	Triggers Auto Camera Setup , which auto-searches and adds cameras to the system.											
	Logs out of the system.											
	Instant Playback	Switches to Playback screen and replays an instant videos starting from some time from now. See Playback to know how to configure where to start replaying an instant video.										
	Layout	Switches the screen between various layouts of camera channels.										
	Auto Scan	Triggers Auto Scan , which enables rotating the channels on the display screen. ▶ See Display for more details about Auto Scan .										
	Group	Manually switches the channels on the display screen.										
	Snapshot	Opens a dialog to capture the screen of the currently selected										

		channel or all channels on the screen. Click OK to save the snapshot to the USB flash drive that mounts the system.
	Digital PTZ	Opens the digital pan/tilt/zoom panel to adjust camera view.
	Physical PTZ	Opens the physical pan/tilt/zoom control panel to adjust camera view. ▶ Available only when the camera supports PTZ.
	Set Preset Point	Sets a point of view of a camera.
	Go to Preset Point	Jumps to a preset point or starts/stops patrol.
	Emergency Record	Enables/disables Always record . ▶ "Always record" means continuous recording, whatever the time period or event is. ▶ See also Mode tab for more details about the recording modes. ▶ See also Camera Status for more details about the recording status.
	Audio	Opens a dialog to adjust audio volume or mute.



Some functions of the **Live View's Toolbar** are also accessible by the **IR Remote Control** that comes with the unit. See [IR Remote Control](#).



5.1.2.2 Status Area

On the **Live View** screen, the right end of the **Status Bar** is an area that shows the system date, time, IP address and so on.



To configure the information delivered by the **Status Area**, see [Status Bar](#).

5.1.2.3 Mode Icon

In the left end of the **Status Bar** is a **Mode Icon** . It delivers that the operating system is currently being used in **Live View** mode; otherwise an  icon will show here to mean the operating system is working in **Playback** mode. In **Live View** mode, the **Mode Icon** doubles as a notification icon to notice users of any system event. When the icon turns red , there is one or more new events coming up and yet to be checked. Click such icon to open a dialog to view the details of a most recent event.

5.2 Playback

The **Playback** is the screen to play the recorded videos. Same as the **Live View** screen, the **Playback** screen is occupied by a predominant video area as well, with a horizontal and rectangular **Status Bar** spreading along the bottom of the screen. The following of this section will guide you through the **Playback's Status Bar** covering **Toolbar**, **Time Bar**, and **Mode Icon**.



5.2.1 Video Area

The screenshot below shows the **Playback's Video Area** when recorded videos are being played.

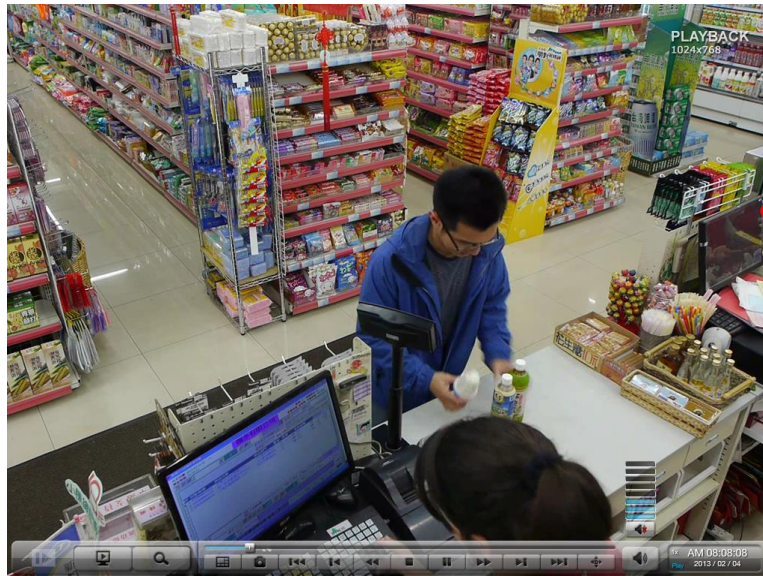



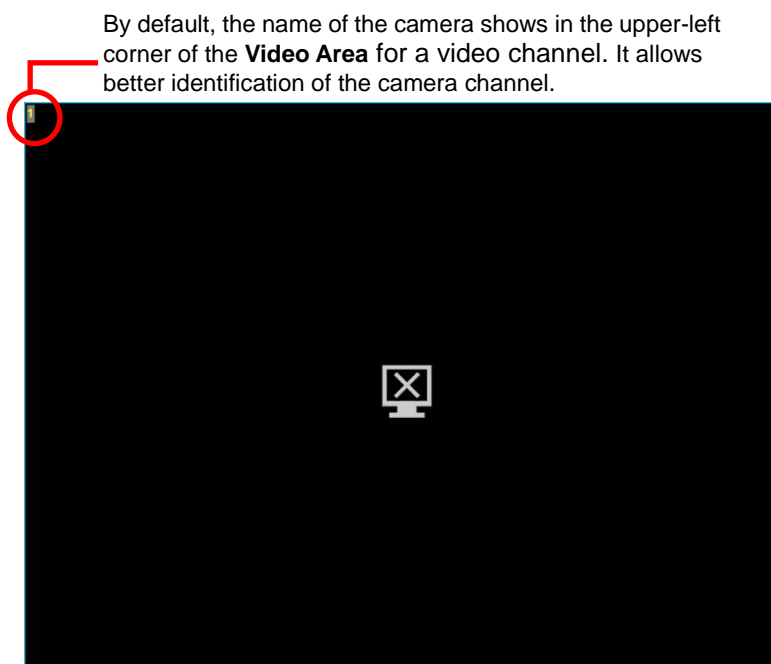

Video Area on the Playback screen

When selecting a period of time without any video recorded on the **Playback's Video Area**, a black screen is showed with nothing but a "no video" icon  in the center.



Video Area on the Playback screen

Icon	Name	Description
	No video	No video is being recorded at the moment.
	No MxPEG	Video being played or recorded with MxPEG codec is currently supported on remote browser/application rather than on the local display.
	Out of resolution: Please set the cameras of which resolution are over 1920x1200	<p>Video being played or recorded with high resolution is with limited support on local display, which is described as below.</p> <p>In firmware version 1.2 or above</p> <ul style="list-style-type: none"> ▶ H.264: no resolution limitation on single channel, the total capacity is around: <ul style="list-style-type: none"> - 8 channels: 5M / others: 2M - 6 channels: 8M / others: 2M *The actual performance depends on the type of cameras. ▶ MPEG4: Up to 2M (1920x1080) per channel ▶ MJPEG: Up to 4M (2560x1600) per channel but with limited fps support <p>Before firmware version 1.2</p> <ul style="list-style-type: none"> ▶ H.264: Up to 4M (2560x1600) per channel ▶ MPEG4: Up to 2M (1920x1080) per channel ▶ MJPEG: Up to 4M (2560x1600) per channel but with limited fps support



To configure how to present the **Video Area**, see [OSD](#).

When using mouse, double-click on the **Video Area** of a video channel to maximize it to full screen. Double-click it again to resize it.

When using the **IR Remote Control**, hit the Enter key to maximize the **Video Area** of a video channel to full screen. And hit the Enter key again to resize it. See also [IR Remote Control](#).



2nd stream playback does not support on local client.

H.265 Live view/ Playback does not support local client.

5.2.2 Status Bar

The **Playback's Status Bar** is presented along the bottom of the screen. It comprises of three facilities, the **Toolbar**, **Time Bar** and **Mode Icon**.

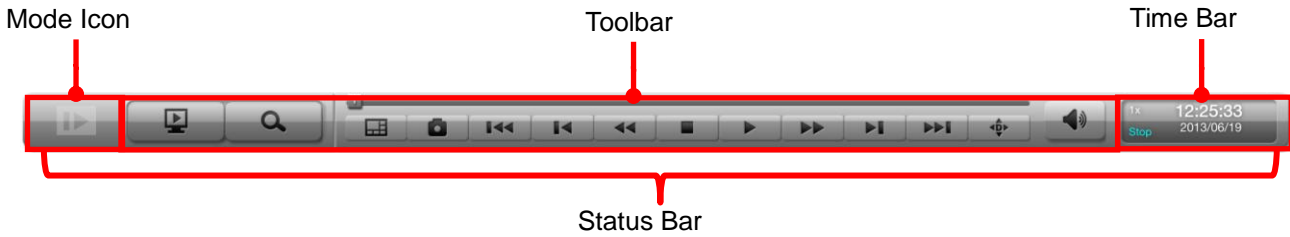





5.2.2.1 Toolbar

The **Toolbar on Playback** screen bears a handful of onscreen buttons. Use these buttons to control the playback of a recorded video.



Button	Name	Description
	Live View	Switches to Live View screen.
	Search	Opens the Search page that searches for a recorded video by the assigned date & time
	Layout	Switches the screen between various layouts of camera channels.
	Snapshot	Opens a dialog to capture the screen of the currently selected channel or all camera channels on the entire screen. Click OK to save the snapshot to the USB flash drive that mounts the system.
	Play / Pause	Starts or temporarily halts the playing.
	Stop	Stops playing. <ul style="list-style-type: none"> ▶ The playback stops by showing the frame where the video starts. ▶ Whether the video is being fast-forwarded or reverse-played at the moment, press Stop will restore the playback speed to x1.
	Step Backward	Hit this key once to bring the playback to the previous key frame .
	Step Forward	Hit this key once to jump the playback to the next frame .
	Previous Interval	Hit this key once to bring the playback to the previous interval . See Playback to know how to set Playback Interval .
	Next Interval	Hit this key once to jump the playback to the next interval . ▶ See Playback to know how to set Playback Interval .

	Rewind	Hit once to rewind the videos with x-1 speed. Hit twice to rewind with x-2 speed. Taper the rewind speed by increasing your keystrokes. When the rewind speed is tapered to x-16, it auto-restores to x-1 speed.
	Fast Forward	Hit once to fast-forward the playback with x2 speed. Hit twice to fast-forward the playback to x4 speed. Increment the fast-forwarding speed by increasing your keystrokes. When the fast-forwarding speed is incremented to x16, it auto-restores to x1 speed.
	Digital PTZ	Opens the digital pan/tilt/zoom panel to adjust camera view.
	Audio	Opens a dialog to adjust audio volume or mute.

 Some functions of the **Playback's Toolbar** are accessible by using the **IR Remote Control** that comes with the unit. See [IR Remote Control](#).

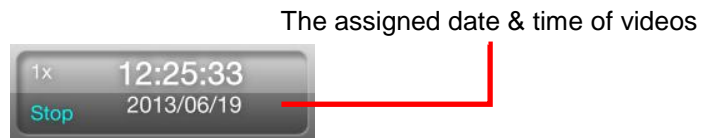

5.2.2.2 Time Bar

On the **Playback** screen, the right end of the **Status Bar** is an area that shows the assigned date and time of videos.





To configure the **Status Area**, see [Status Bar](#).

5.2.2.3 Mode Icon

In the left end of the **Status Bar** is a **Mode Icon** . It delivers that the operating system is currently being used in **Playback** mode; otherwise an  icon will show here to mean the operating system is working in **Live View** mode.

5.2.2.4 Search to Playback/Backup

To retrieve videos to playback or backup, click on the  icon to open a time table indicating record video footages. By selecting the start time and click on the  icon, the videos available in the following 48 hours from the start time will be shown as the blue bar. Designate the range to do further.

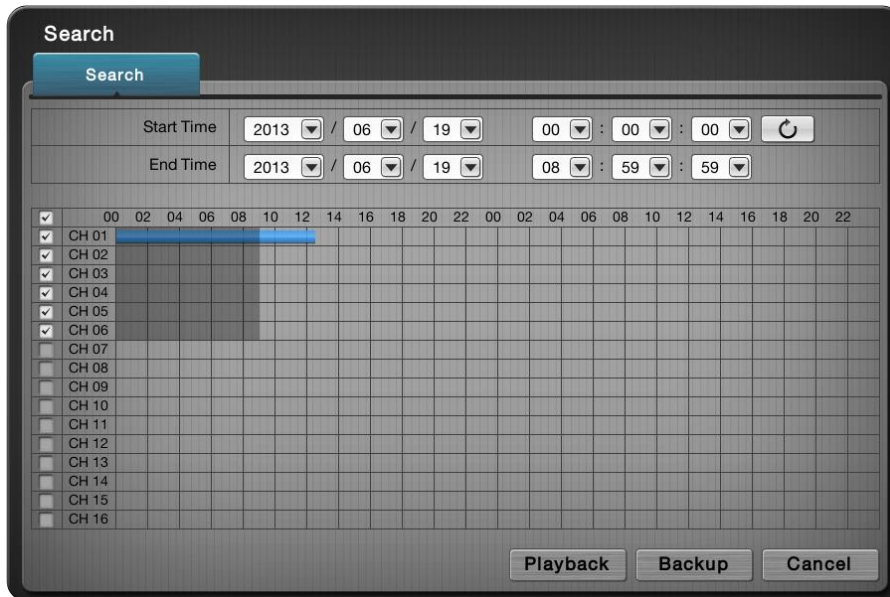

USB flash drive and portable hard disk device are both supported for video backup. If you encounter problems when trying to backup on portable hard disk device, please format the device with FAT32, NTFS is not supported currently.

6 Settings

The operating system features the **Main Menu** to set up camera, manage recording and event, to configure networking, to power on/off the unit and so on. This chapter will guide you to each submenu and each setting.

To access the settings:

Open **Live View** screen. (See [Live View](#) and [Playback](#).)

The **Live View** screen opens.

Click the menu list button  from the **Status Bar**.





Menu list opens.

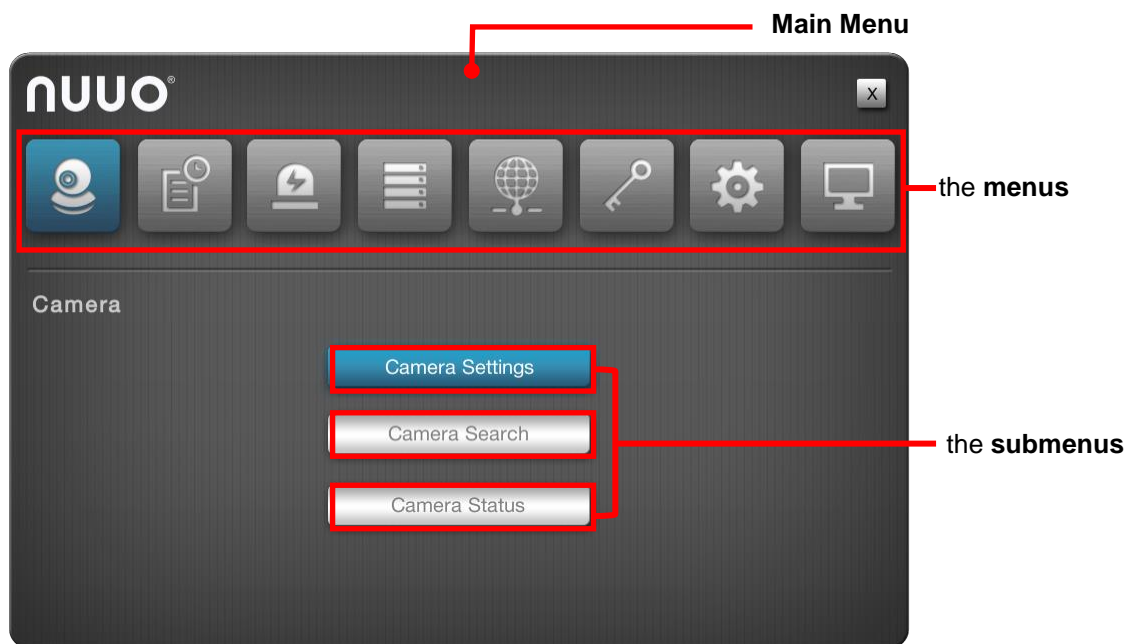



Click **Main Menu** button .

The **Main Menu** opens and shows the **Camera** menu by default.



The **Main Menu** features eight **menus**:

Menu	Button	Summary
Camera		Search for cameras and adds cameras within the same subnet. ▶ See Camera for the settings..
Recording & Event		Configures video recording schedule and sets the events to alarm for. ▶ See Recording & Event for the settings.
Device		Manages camera input/output. ▶ See Device for the settings.
Storage		Manages the system's storage and data backup. ▶ See Storage for the settings.

Network		Configures the systems' networking. ▶ See Network for the settings.
Management		Manages the list of the users permitted to access the system, activate license, save/load configuration and check logs ▶ See Management for the settings.
System		Views system information, configures system settings, manages system upgrade, and run Install Wizard ▶ See System for the settings.
Display		Configures the system's display. ▶ See Display for the settings.

6.1 Camera

The **Camera** menu helps users search for cameras and adds cameras within the same subnet.

To access the **Camera** menu:

Open the **Main Menu** as described in [Settings](#)

The **Main Menu** opens.

Click the **Camera** button .

The **Camera** menu opens.

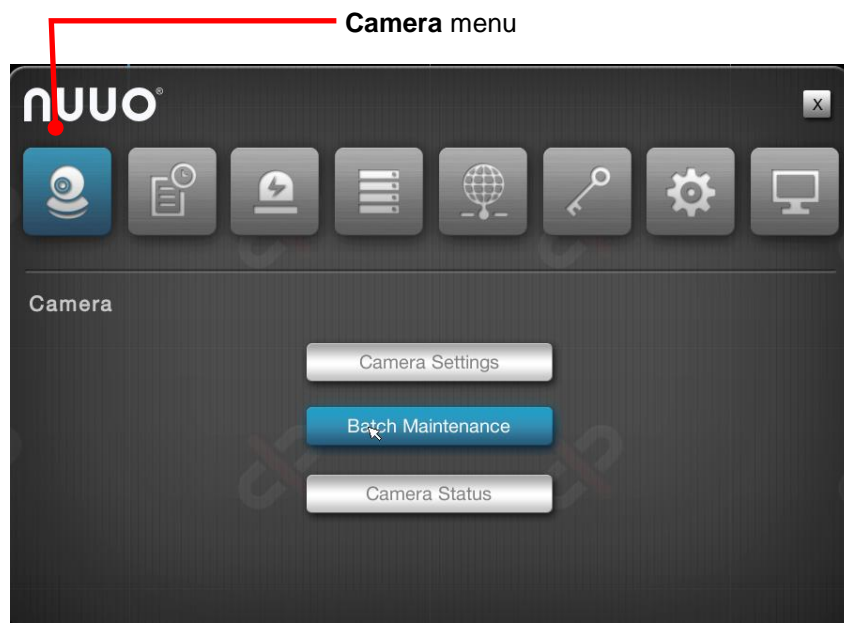

The **Camera** menu features the submenus **Camera Settings**, **Batch Maintenance** and **Camera Status**, which are explicated in the following of this section.

6.1.1 Camera Settings

This submenu enables user to manually add cameras in the same subnet.

To access the **Camera Settings** submenu:

Open **Camera** menu as described in [Camera](#).

Camera menu opens.

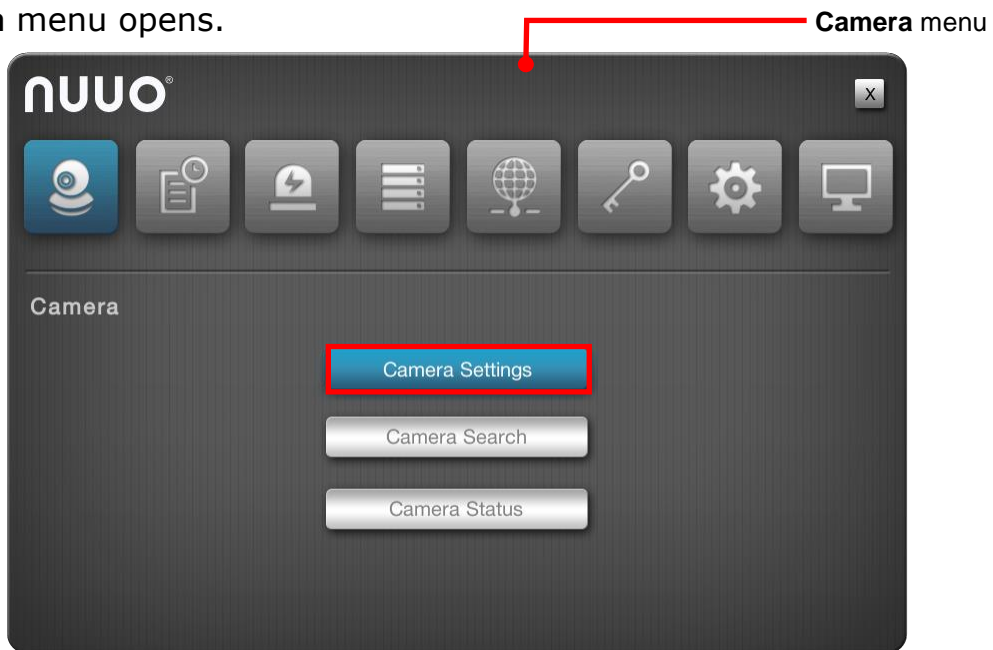

Click **Camera Settings** button.

Camera Settings submenu opens and shows the **Settings** tab.

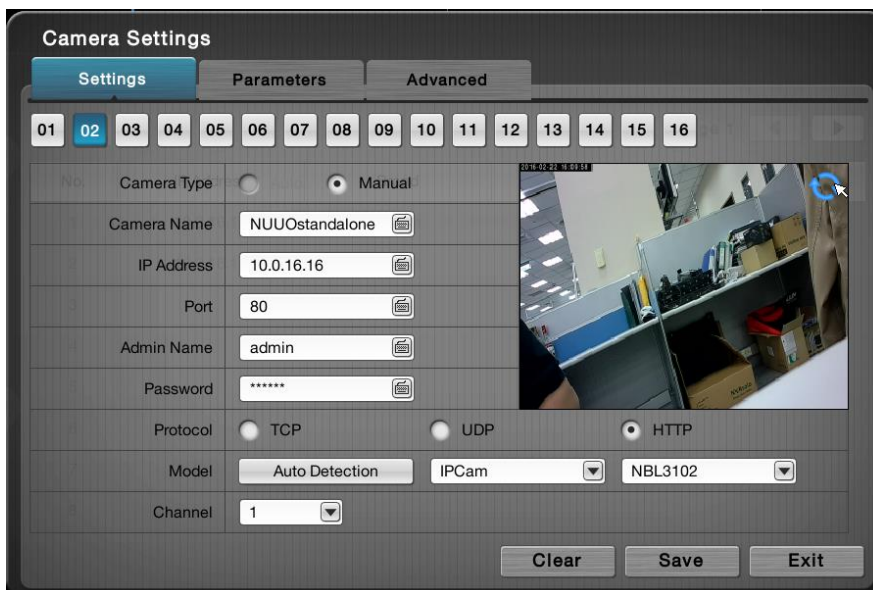



Camera Settings features 3 tabs: **Settings**, **Parameters** and **Advanced** which are detailed in the following of this section.

6.1.1.1 Settings tab

The **Settings** tab enables users to manually add camera(s).

To access the **Settings** tab:

On the **Live View** screen, click menu list button  > **Main Menu** button  > **Camera** button  > **Camera Settings** button > **Settings** tab.

The **Settings** tab is displayed.

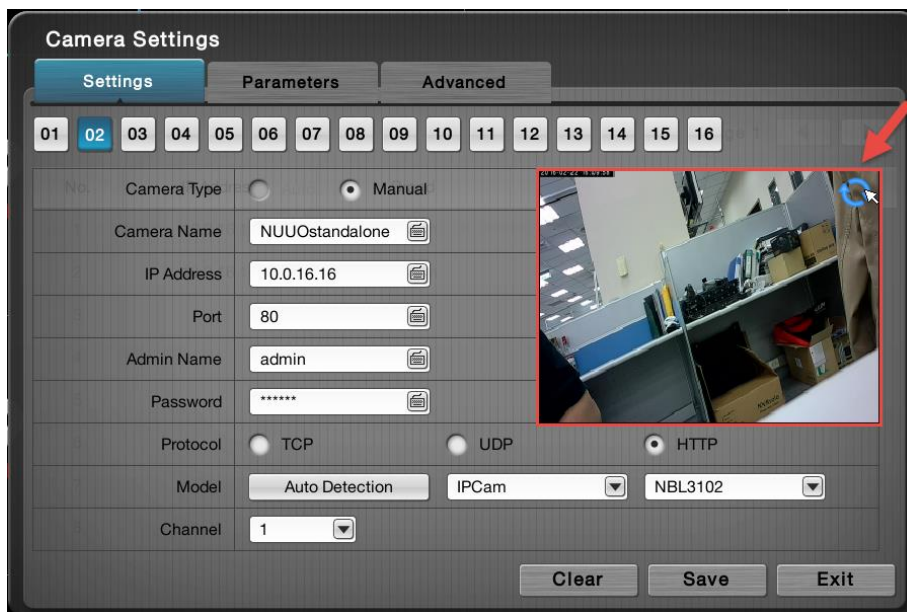





The red square screen is the image preview function for local server, and the image is the snapshot of the camera.

By pressing , user can refresh the current image of the certain camera.

On the **Settings** tab, the featured settings are:

Setting	Description	Default
	Selects the camera channel to configure <ul style="list-style-type: none"> ▶ In default state, 1bay unit is embedded with 4 channels. ▶ Upgrade the operating system with a license serial number to have more channels for viewing and recording. A 1bay unit can have up to 8 channels. 	01

Camera Type	Camera type is set to IP camera, or camera that was added manually	IP
Camera Name	Sets the camera name. ▶ Click the keyboard icon  at the right of the field to open the virtual keyboard for name input.	--
IP Address	Sets the camera's IP address. ▶ Click the keyboard icon  at the right of the field to open the virtual keyboard for text input.	--
Port	Sets the port number. ▶ Click the keyboard icon  at the right of the field to open the virtual keyboard for text input.	80
Administrator	Set the name for the administrator, who is a user privileged to fully manage the camera. ▶ Click the keyboard icon  at the right of the field to open the virtual keyboard for text input.	--
Password	Sets the password to login as the administrator of the camera. ▶ Click the keyboard icon  at the right of the field to open the virtual keyboard for text input.	--
Protocol	Sets the protocol for the camera. ▶ This setting is only available after Model setting is done. ▶ Options available are TCP , UDP and HTTP . However the option availability depends on camera's brand and model.	--
Model	Auto-detects camera brands and models, or lets users manually select camera model/brand from the in-built drop-down lists.	--
Channel	Sets the number of analog cameras supported by one video server or sets the number of IP cameras possessing multiple lens/channels. ▶ This setting is only available after the camera's brand and model name is provided in Model setting.	--

Click the **Save** button to apply the change(s).

To remove the camera settings, click the **Clear** button and then **Save** button to apply.

After changes made, click the **Exit** button to quit the tab.

6.1.1.2 Parameter tab

The **Parameter** tab configures how the camera records and how live videos are played on **Live View** screen.



To access the **Parameter** tab:

On the **Live View** screen, click menu list button  > **Main Menu** button 

> **Camera** button  > **Camera Settings** button > **Parameters** tab.

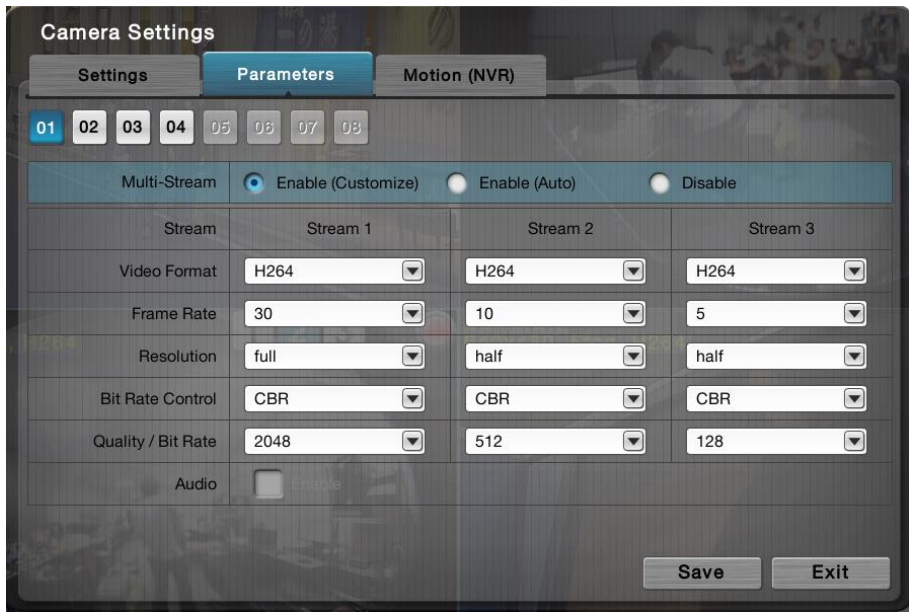
The **Parameters** tab will open.



Setting	Description	Default
	Selects a camera channel to configure. <ul style="list-style-type: none"> In default state, 1bay unit is embedded with 4 channels.. Upgrade the operating system with a license serial number to have more channels for viewing and recording. A 1bay unit can have up to 8 channels. 	
Multi-stream	Enable/Disable camera multi-stream.	Enable(Auto)
Stream	Support up to three streams.	--
Video Format	Sets the formats that the camera supports. <ul style="list-style-type: none"> Options available are H.264, MPEG4, MJPEG and MxPEG. However the option availability depends on camera's brand and model. Currently MxPEG decoding isn't supported on local display. The MxPEG-decoded videos can only be viewed via web or remote browser. 	--
Frame Rate	Sets the frame rate of the camera.	--
Resolution	Sets the video resolution of the camera.	--
Bit Rate Control	Sets the bit rate control of the camera.	--
Quality/Bit Rate	Sets the video image quality of the camera.	--
Audio	Enables/disables viewing and recording videos with audio. <ul style="list-style-type: none"> Audio playing on local side isn't supported in v1.0. 	--

Click the **Save** button to apply the change(s)

Click the **Exit** button to quit the tab.

6.1.1.3 Advanced

The Advanced menu allows user to set up **Motion Detection** (NVR motion or IPC motion), detection's **Sensitivity**, **Interval** and **Detection Area**.



Please note this defines the server's motion detection, not camera's motion detection. For camera's motion detection, please access it directly via camera's application or webpage.

You can select which channel to apply the motion detection.

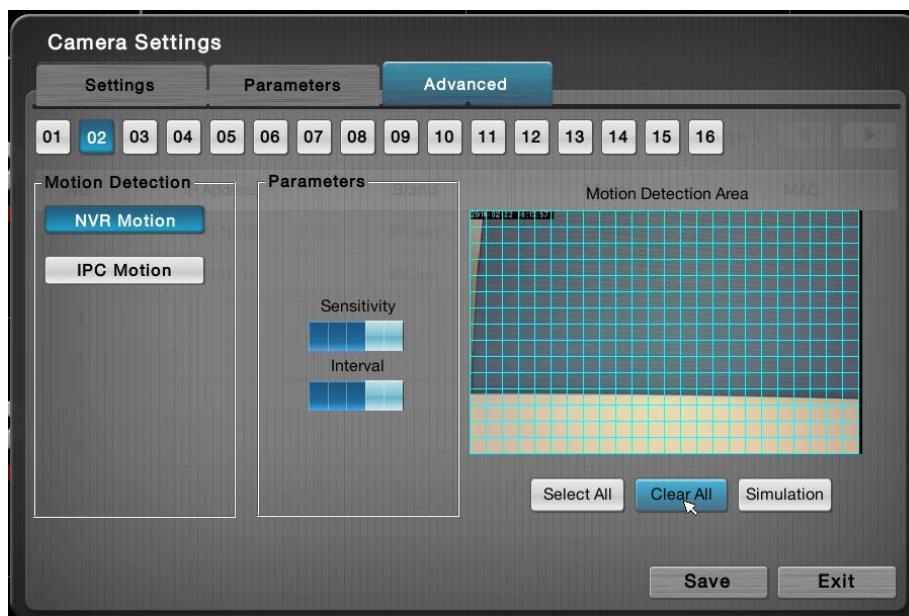

To set up motion detection, choose NVR Motion, and video from the camera will appear.

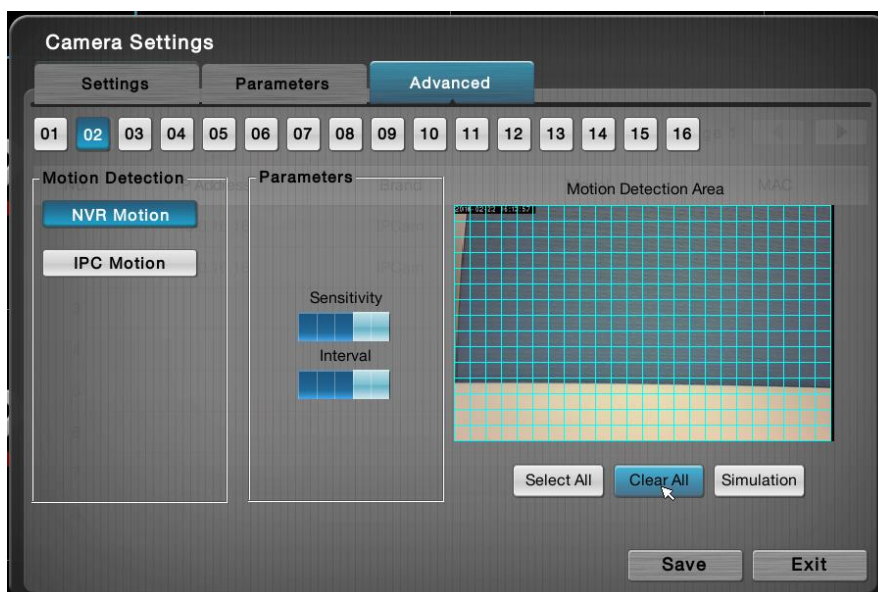

Set up motion detection area

- Mouse: Left click and drag the required area, and release the left mouse button.
- Keyboard: Use cursor and move to the desired area, press [Enter/Return] and move the cursor to expand the red highlighted area.
- Remote Control: Similar to the keyboard, use cursor and move to the desired area, press [Enter/Return] and move the cursor to expand the red highlighted area.

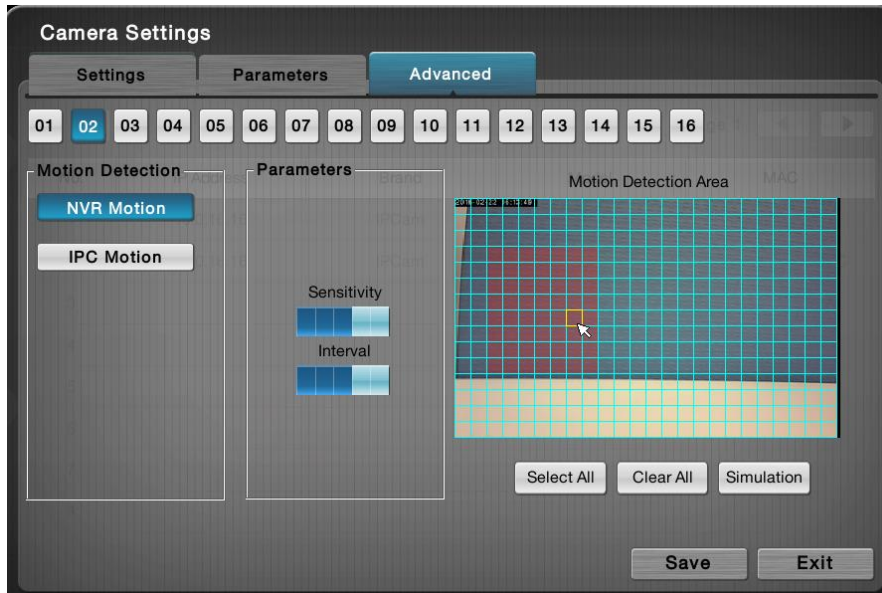

To de-select highlighted areas, perform the same action as described above, but with the starting point on a selected area.

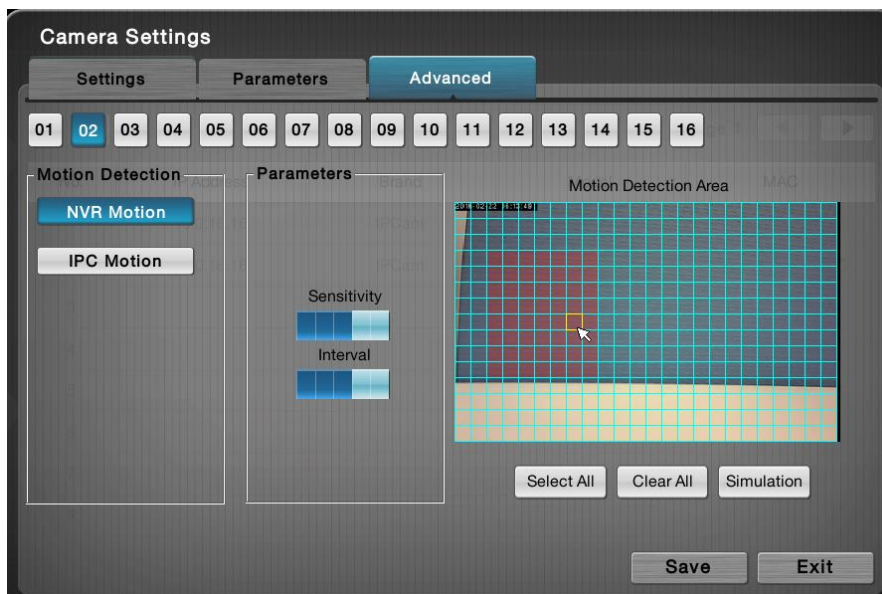

There can be multiple detection areas.

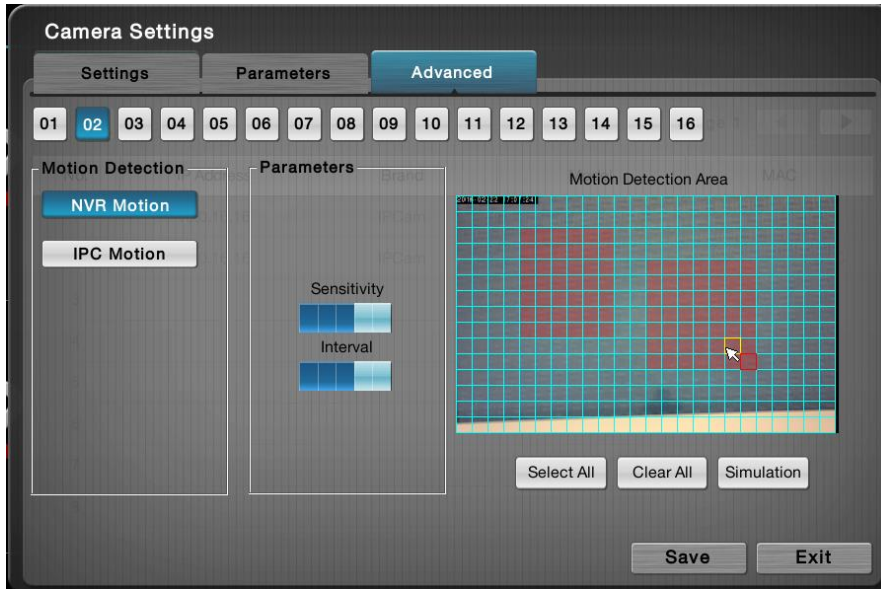

Click on [Select All] to highlight entire view.

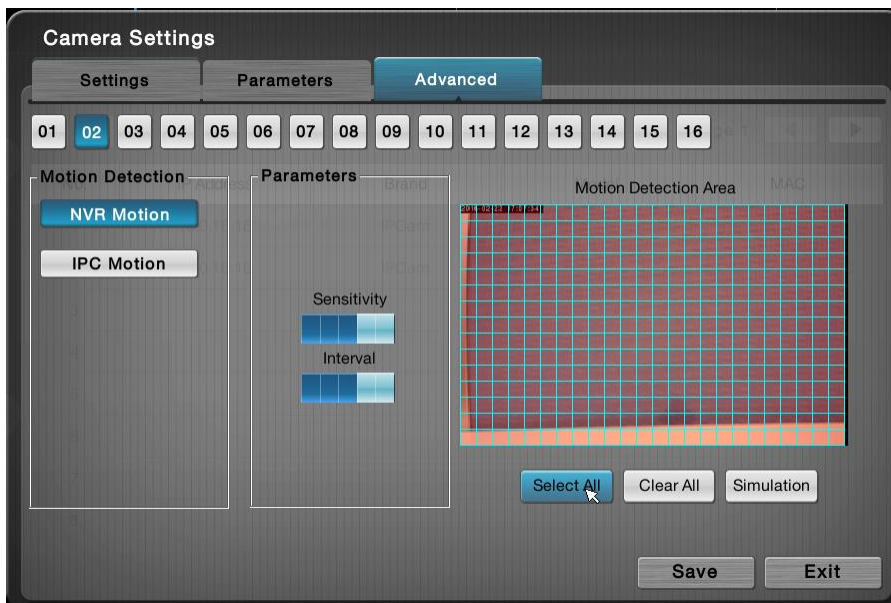

Click on [Clear All] to de-select all highlighted areas.

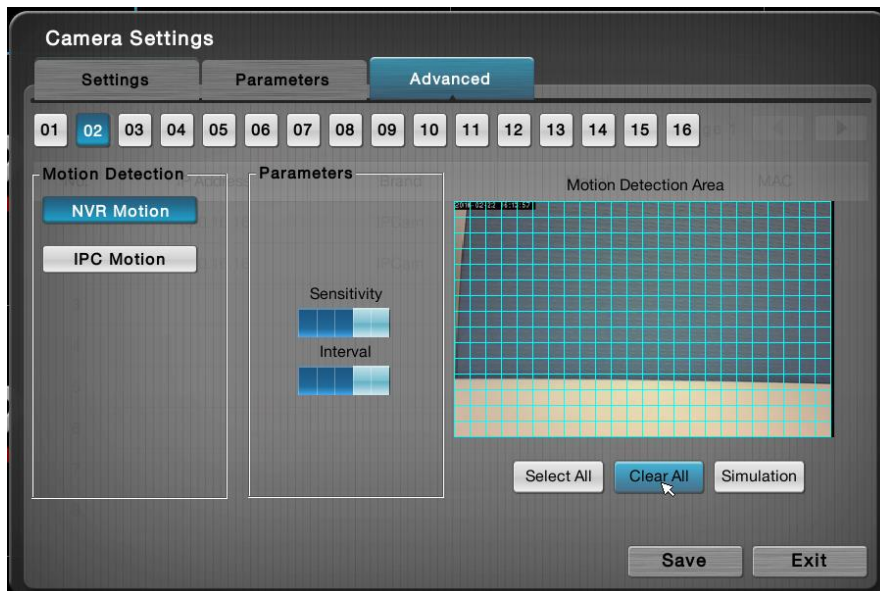

Sensitivity and Interval

Sensitivity: Click and increase darker bar levels to the right to increase sensitivity so that minimal movement will trigger the alarm. Decrease the bar levels to the left to reduce the sensitivity. Setting up an appropriate sensitivity value will minimize false alarms, for example you can lower the sensitivity level to avoid alarm being triggered by a swinging tree in the breeze.

Interval: Click and increase darker bar levels to the right to increase interval time so that the alarm will only be triggered when the movement lasts longer. Move to the left to reduce the interval. Setting up an appropriate interval value will reduce the chance of false alarms, for example, you can lower the interval to avoid the alarm being triggered by a pedestrian.

Simulation

Click the Simulation button and test the motion detection effect on the preview screen. If a certain motion is considered as event, "Event triggered" will appear on the preview screen. You can adjust the sensitivity level and interval to reduce false alarms according to each camera.

Must click save button after setting the areas, afterwards by clicking Simulation for testing the motion detection with certain area.

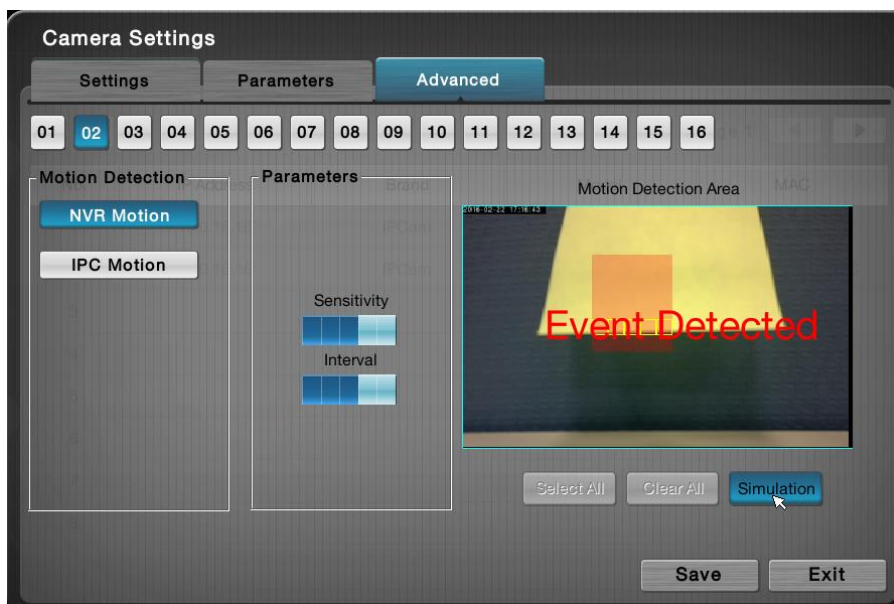

6.1.1.4 IPC Motion

The IPC Motion allows user to set up motion detection on local client.

User can select which channel to apply the motion detection.

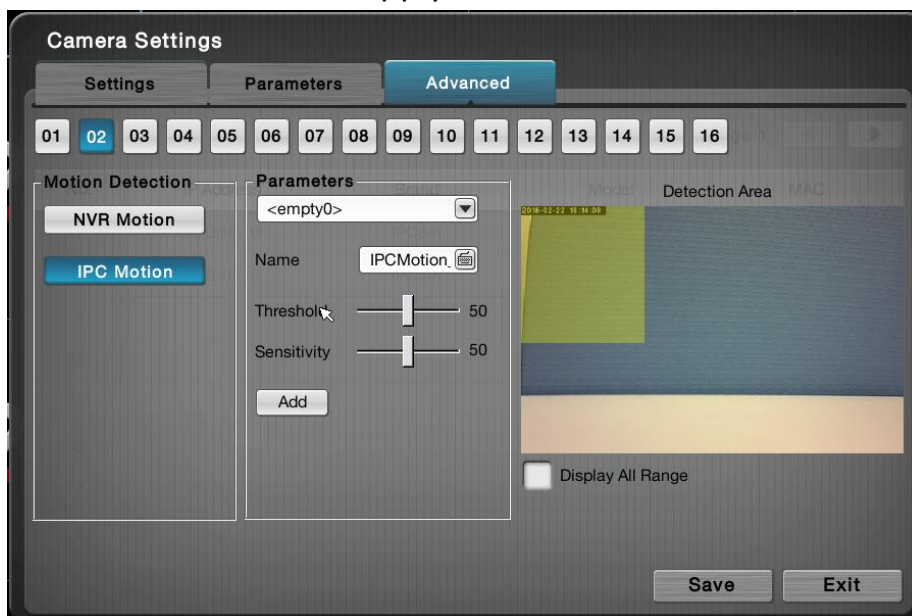

To set up motion detection, choose IPC Motion, and video from the camera will appear.

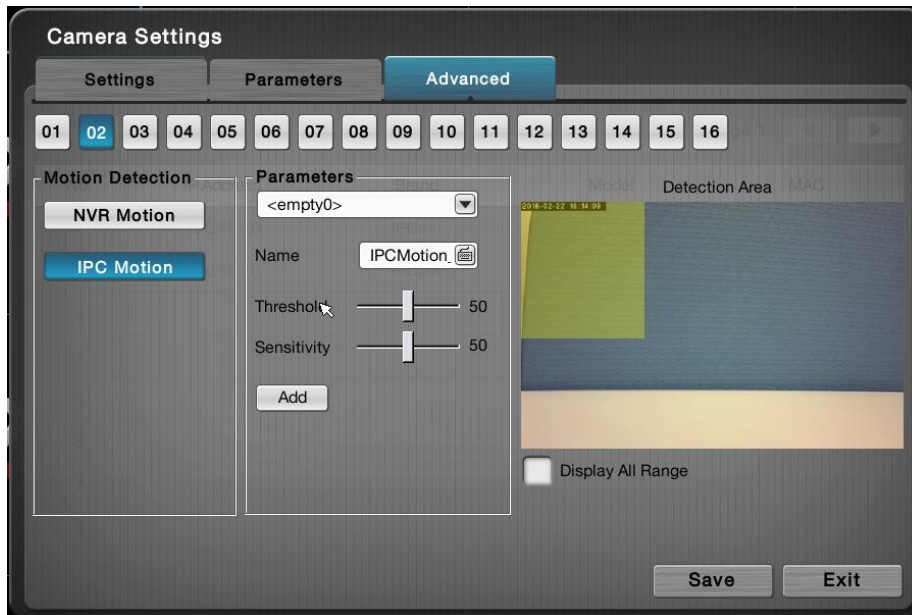

Set up motion detection area

- Mouse: Left click and drag the required area, and release the left mouse button.

User can name motion detection by clicking virtual keyboard  from parameters.

User can modify the Threshold and Sensitivity,

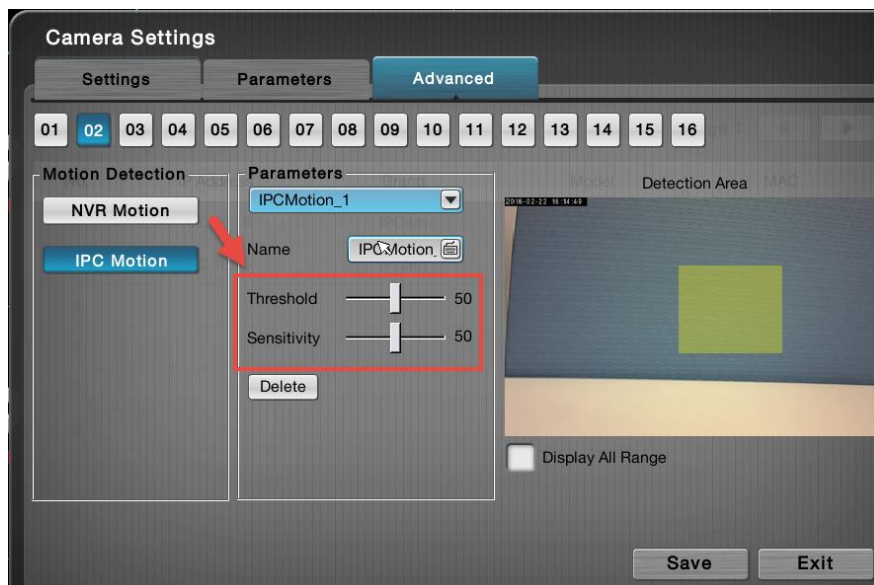

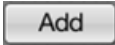
Clicking the Add button  to create new motion detection after all the settings are done.

Multi-detection areas are available.

Ticking Display All range box Display All Range to show multi-areas.

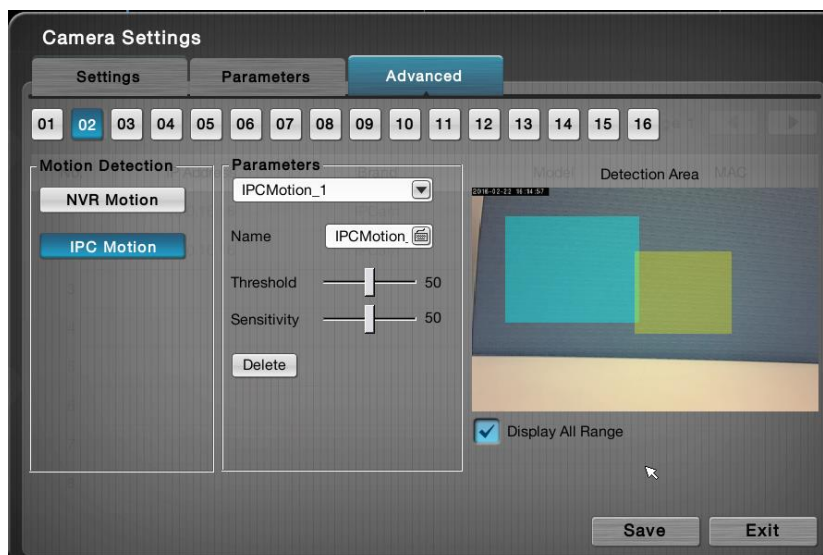

Sensitivity and Threshold

Sensitivity: dragging the button to increase or decrease number of sensitivity so that different level of movement will trigger the alarm based on the sensitivity. Setting up an appropriate sensitivity value will minimize false alarms, for example you can lower the sensitivity level to avoid alarm being triggered by a swinging tree in the breeze.

Threshold: dragging the button to increase or decrease number of Threshold so that the alarm will only be triggered when the movement exceeds the certain reaction. Setting up an appropriate Threshold value will reduce the chance of false alarms.

6.1.2 Batch Maintenance

Batch Maintenance enables several functions that include Naming, Camera firmware upgrade, Language pack upload, Reboot, Reset to default. The search relies on UPnP. Before using this function, make sure your camera supports UPnP. Refer to the camera support list at www.nuuo.com.

To access the **Batch Maintenance** submenu:

Open **Camera** menu as described in [Camera](#).

The **Camera** menu **opens**.

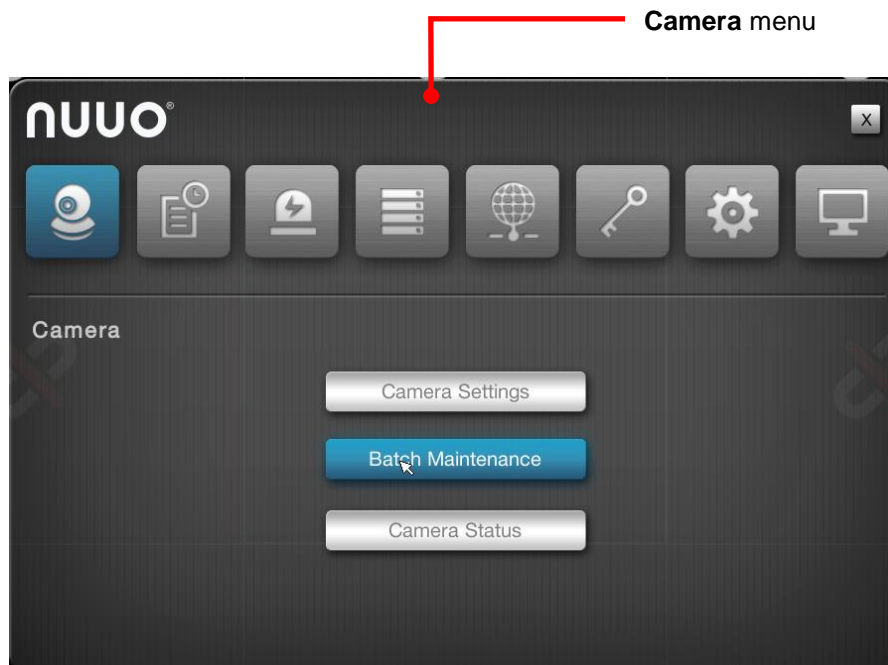

Click **Batch Maintenance** button.

In naming page, user can have image preview with certain camera, and give the certain to the camera by using virtual keyboard .

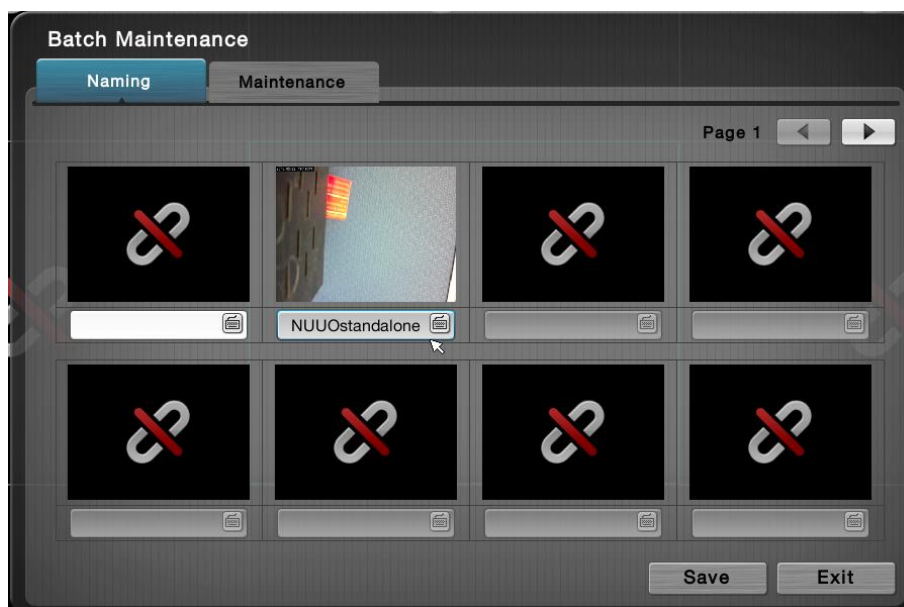

Click the **Maintenance** button.

In Maintenance page, system enables user to upgrade camera firmware, upload language pack and reboot, reset camera to default setting.

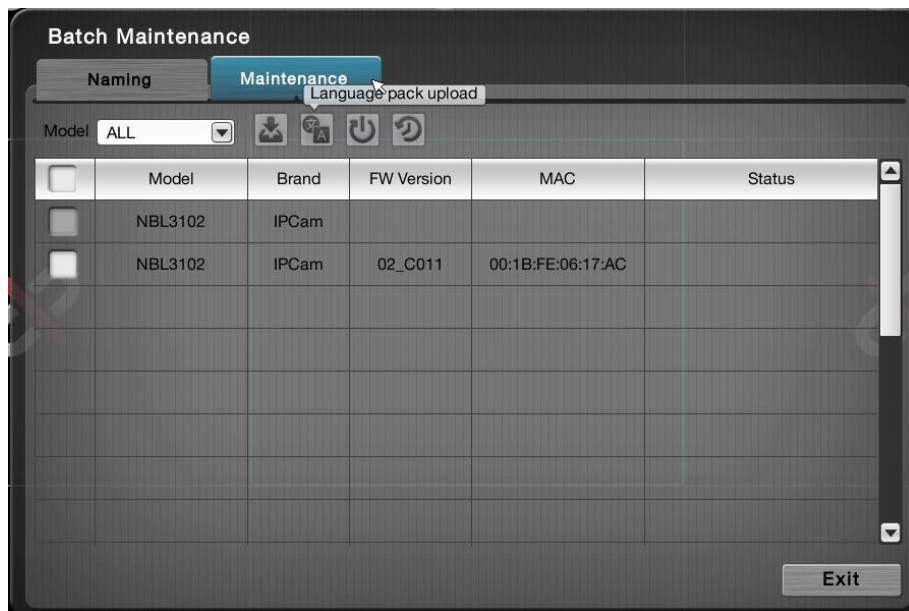

User can view all the connection cameras' model or certain model by using filter.

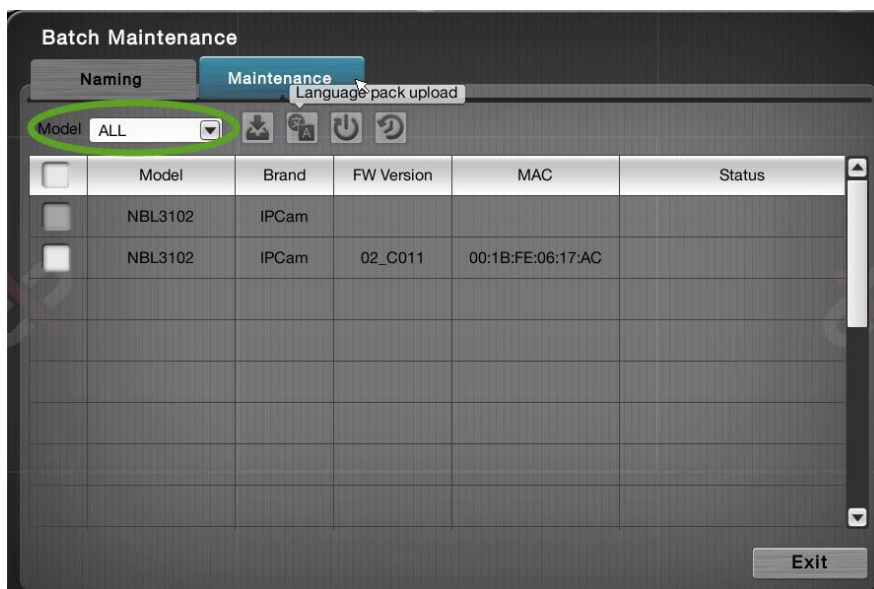

To enable the maintenance features, user needs to tick up the certain model, and the button of those functions from firmware upgrade to reset to default will turn bright.

6.1.3 Camera Status

Use **Camera Status** to monitor camera statuses including connection and disconnection. It also helps users to have an overview of the camera status and total bit rate.

To access the **Camera Status** submenu:

Open **Camera** menu as described in [Camera](#).

The **Camera** menu opens.

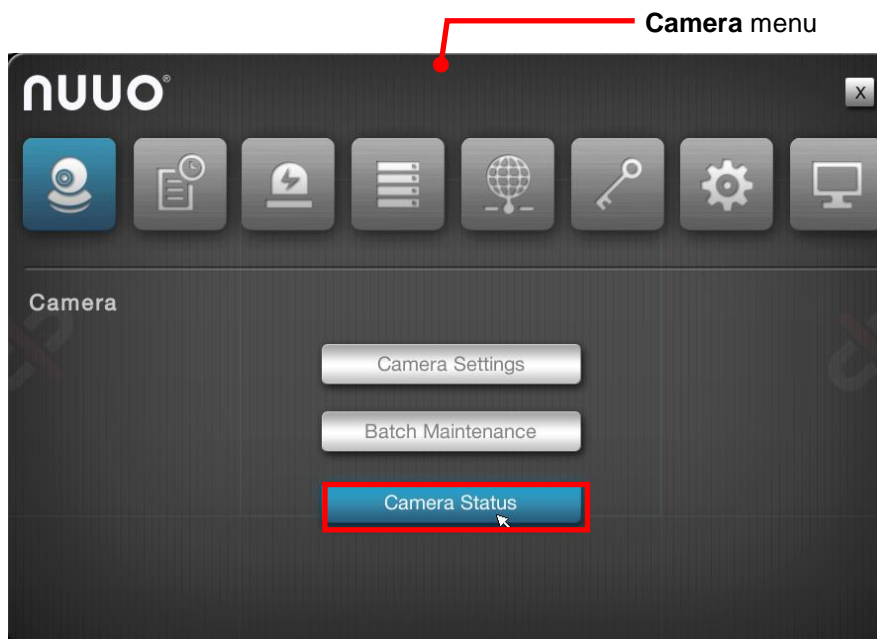

Click **Camera Status** button and shows the **Camera Status** tab.

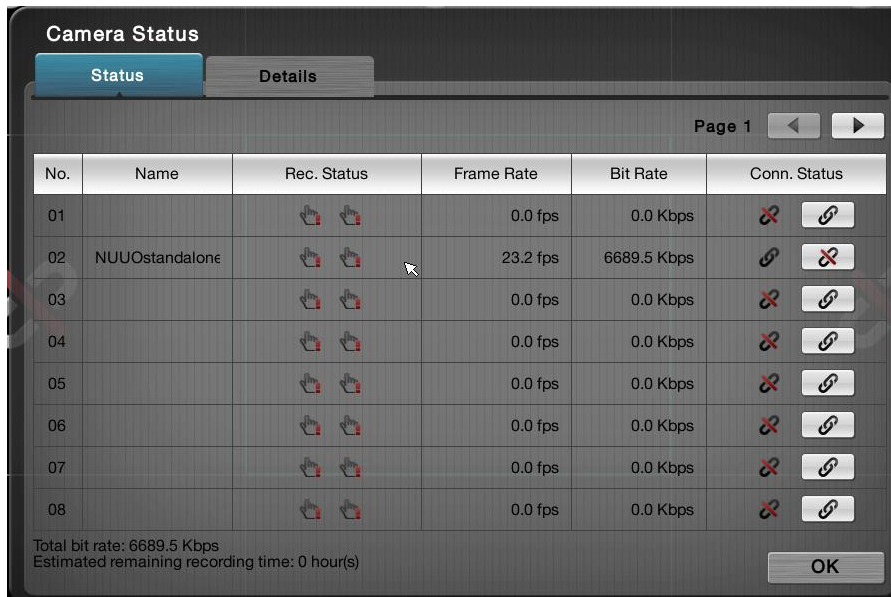

The **Camera Status** menu features the submenus **Camera Status**, and **Details**, which are explicated in the following of this section.

6.1.3.1 Camera status tab

The **Camera Status** tab shows camera statuses including connection and disconnection. It also helps users to have an overview of the camera status and total bit rate.

To access the **Camera Status** tab:

On the **Live View** screen, click menu list button > **Main Menu** button > **Camera** button > **Camera Status** button > **Camera Status** tab.

The **Camera Status** tab will open.

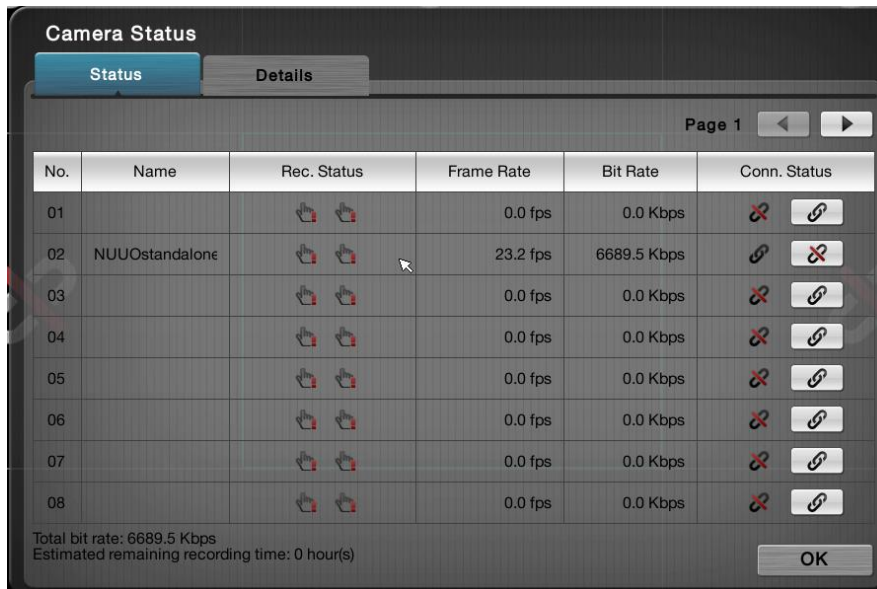

Camera Status delivers the info of each added camera including the following:



Info Item	Description	Status Info/Icon
No.	Delivers the channel of the camera.	--
Name	Delivers the name of the camera.	--
Recording Status	Delivers the recording mode and recording status.	No recording Always recording - recording Always recording - stopped Always recording with 2 nd stream Always recording with 1 st stream Always recording - Dual record Schedule recording - recording Schedule recording - stopped Emergency recording - recording Emergency recording - stopped
Frame Rate	Delivers the frame rate of the camera.	--
Bit Rate	Delivers the transmission bit rate of the camera.	--
Connection. Status	Delivers the camera's connection status.	Disconnected. Connected Connecting...
	Connects or disconnects a camera.	Hit to connect Hit to disconnect

Click the **OK** button to quit the tab.

6.1.3.2 Details tab

The **Details** tab shows camera streams statuses including stream 1, stream 2 and stream 3. It also provides the total bit rate of single camera and all camera totals.

To access the **Details** tab:

On the **Live View** screen, click menu list button  > **Main Menu** button 
> **Camera** button  > **Camera Status** button > **Details** tab.

The **Details** tab will open.

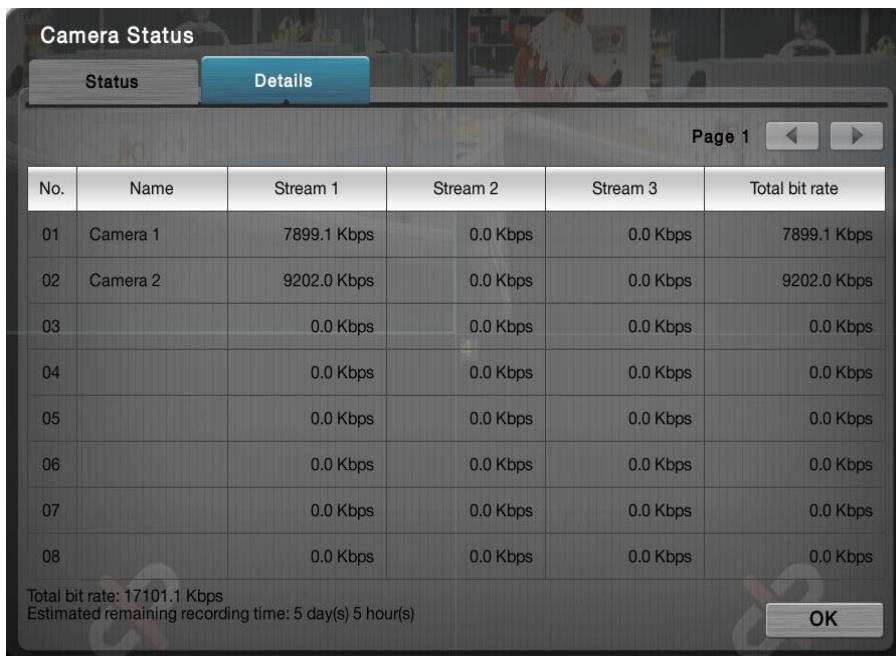

The screenshot shows the 'Camera Status' window with the 'Details' tab selected. It displays a table with 8 rows of camera data. The first two rows show 'Camera 1' and 'Camera 2' with their respective bit rates. The remaining six rows show cameras with 0.0 Kbps for all streams. At the bottom, there is a summary of the total bit rate and estimated recording time, along with an 'OK' button.

No.	Name	Stream 1	Stream 2	Stream 3	Total bit rate
01	Camera 1	7899.1 Kbps	0.0 Kbps	0.0 Kbps	7899.1 Kbps
02	Camera 2	9202.0 Kbps	0.0 Kbps	0.0 Kbps	9202.0 Kbps
03		0.0 Kbps	0.0 Kbps	0.0 Kbps	0.0 Kbps
04		0.0 Kbps	0.0 Kbps	0.0 Kbps	0.0 Kbps
05		0.0 Kbps	0.0 Kbps	0.0 Kbps	0.0 Kbps
06		0.0 Kbps	0.0 Kbps	0.0 Kbps	0.0 Kbps
07		0.0 Kbps	0.0 Kbps	0.0 Kbps	0.0 Kbps
08		0.0 Kbps	0.0 Kbps	0.0 Kbps	0.0 Kbps

Total bit rate: 17101.1 Kbps
Estimated remaining recording time: 5 day(s) 5 hour(s)

OK

6.2 Recording & Event

Exactly as the name suggests, the menu **Recording & Event** helps users configure video recording and sets the events to alarm for.

To access the **Recording & Event** menu:

Open the **Main Menu** as described in [Settings](#)

The **Main Menu** opens.

Click **Recording & Event** button .

The **Recording & Event** menu opens.

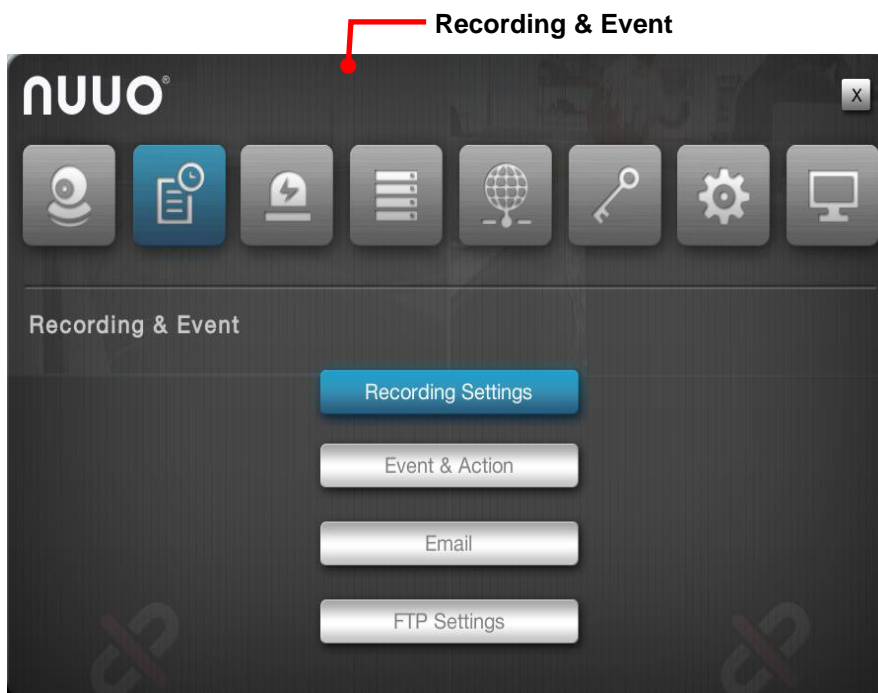

The **Recording & Event** menu features the submenus **Recording Settings**, **Event & Action**, **Email** and **FTP Settings**, which are explicated in the following of this section.

6.2.1 Recording Settings

The **Recording Settings** submenu configures how and when to record videos and which events to trigger recording for.

To access the **Recording Settings** submenu:

Open **Recording & Event** menu as described in [Event & Action](#).

The **Recording & Event** menu opens.

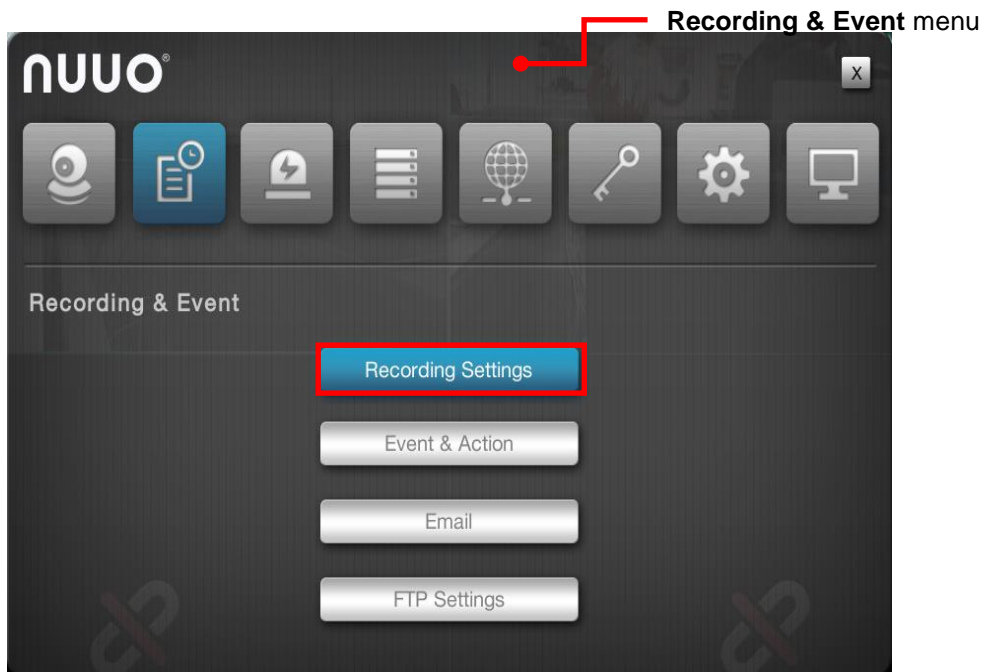

Click **Recording Settings** button.

The **Recording Settings** submenu opens and shows the **Mode** tab.

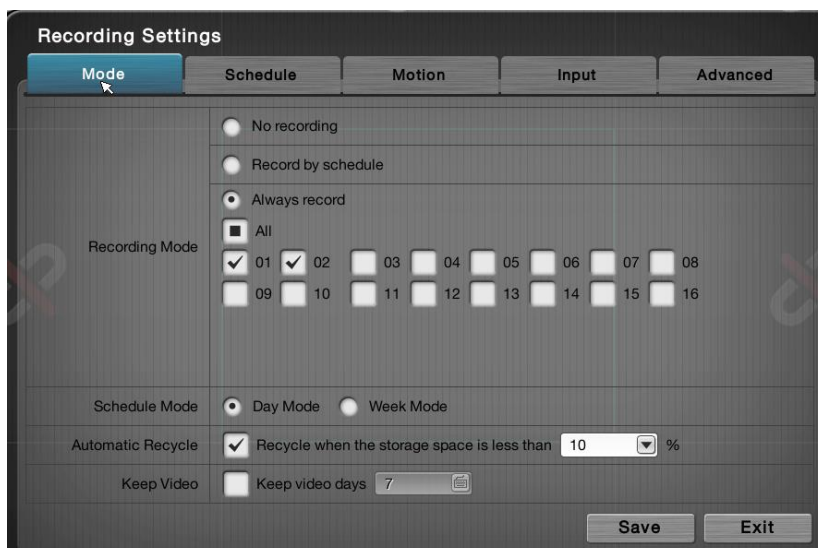



The **Recording Settings** submenu features four tabs: **Mode**, **Schedule**, **Motion** and **Input**, which are detailed in the following of this section.

6.2.1.1 Mode tab

The **Mode** tab enables/disables recording and sets how to record videos.

To access the **Mode** tab:

On the **Live View** screen, click menu list button  > **Main Menu** button  > **Recording & Event** button  > **Recording Settings** button > **Mode** tab.

The **Mode** tab then opens

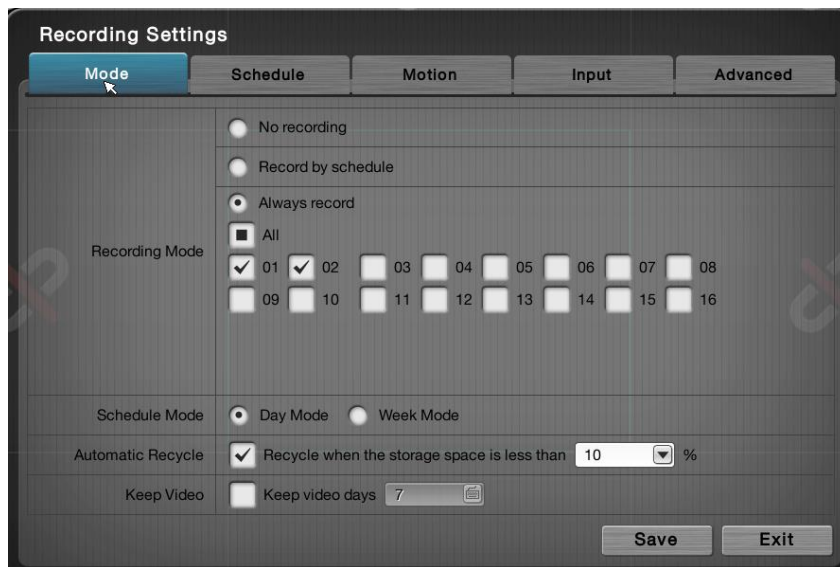

On the **Mode** tab, the featured settings are:

Group Box	Setting	Description	Default	
Recording Mode	No Recording	Disables video recording	If any storage is present, the default is Always record ; otherwise No Recording is the default.	
	Record by schedule	Enables recording and records by schedule. ▶ See Schedule tab to know how to record videos by schedule.		
	Always record	All		Enables all camera channels to record always.
		Channel #		Enables a camera channel to record always. ▶ A 1bay unit can have up

			to 8 channels.	
Schedule Mode	Day Mode	Daily repeats the recording schedule. ▶ For further schedule settings, see Schedule tab .		Selected (Enabled)
	Week Mode	Weekly repeats the recording schedule. ▶ For further schedule settings, see Schedule tab .		Deselected (Disabled)
Automatic Recycle	Enable	Enables automatic recycle when the storage space is less than a certain percentage.		Selected (Enabled) 10%
Keep Video	Keep days video	Set how long to keep the recorded video clips for. (Max: 365 days)		Deselected (Disabled)



The actual days of video kept depends on the available disk space.

Click the **Save** button to apply the change(s).

Click the **Exit** button to quit the tab.

6.2.1.2 Schedule tab

The **Schedule** tab sets the schedule to record videos.

To access the **Schedule** tab:

On the **Live View** screen, click menu list button  > **Main Menu** button 

> **Recording & Event** button  > **Recording Settings** button > **Schedule** tab.

The **Schedule** tab then opens in context with the **Schedule Mode** setting on the **Mode** tab. (See also [Mode tab](#).)

The **Schedule** tab with the **Schedule Mode** set to **Day Mode** on the **Mode** tab.

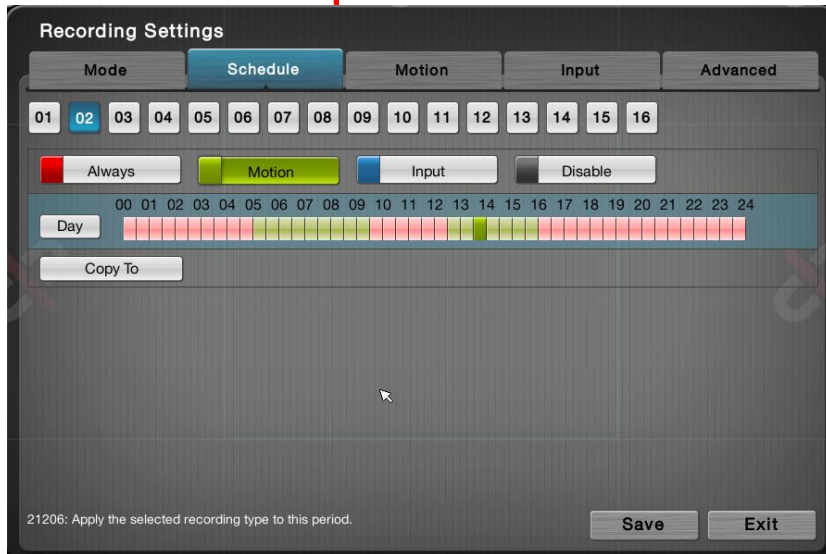

User can back to Mode page and change schedule mode from **Day mode** to **Week mode**.

The **Schedule** tab with the **Schedule Mode** set to **Week Mode** on the **Mode** tab.

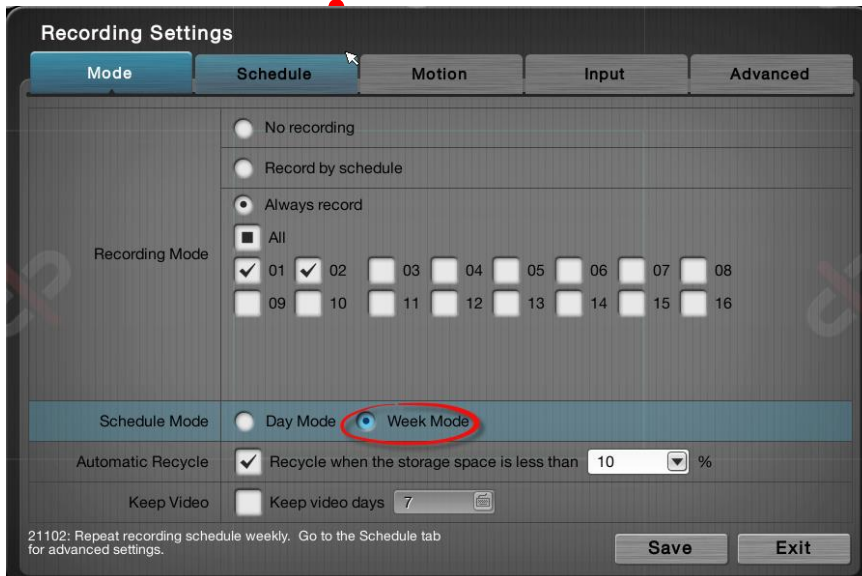

And back to schedule page.

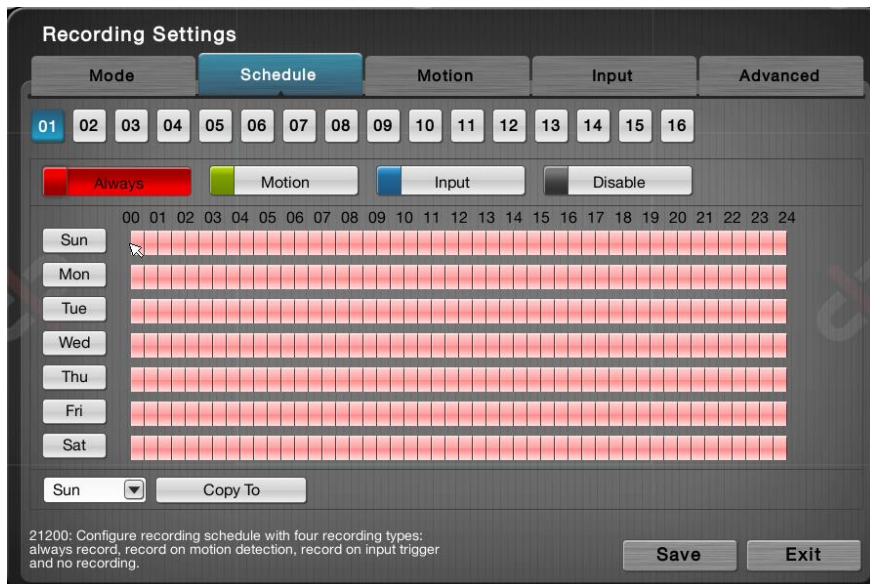

On the **Schedule** tab, the featured settings are:

Setting	Description	Default
	Selects a camera channel to configure.	
	This is a marker button of the Always recording type. Click this button to be able to mark a time slot as "Always record".	--
	This is a marker button of the Motion recording type. Click this button to be able to mark a time slot to record video upon the detection of video motion. <ul style="list-style-type: none"> ▶ This setting requires related video motion detection settings on the Motion tab. See Motion tab . ▶ Before setting video motion events, make sure the camera's video motion detection is enabled on camera web. 	--
	This is a marker button of the Input recording type. Click this button to be able to mark a time slot to record video upon digital input. <ul style="list-style-type: none"> ▶ This setting requires related digital input detection setting on Input tab first. See Input tab. 	--
	This is a marker button of the Disable recording type. Click this button to disable a time slot from video recording.	--
	In the week mode, selects a week day from which the schedule is copied to other week day(s) or video channels.	--
	In the day mode, applies the current day schedule to other channel(s). In the week mode, applies the current week schedule to other week day(s) or applies all week schedule to other channels.	--

By default, the camera is set to "always record" from 00:00 to 24:00.



Click the **Save** button to apply the change(s).

Click the **Exit** button to quit the tab.

6.2.1.3 Motion tab

The **Motion** tab helps users set the pre- and post-recording time upon the camera’s detection of video motion.

To access the **Motion** tab:

On the **Live View** screen, click menu list button  > **Main Menu** button 

> **Recording & Event** button  > **Recording Settings** button > **Motion** tab.

The **Motion** tab then opens

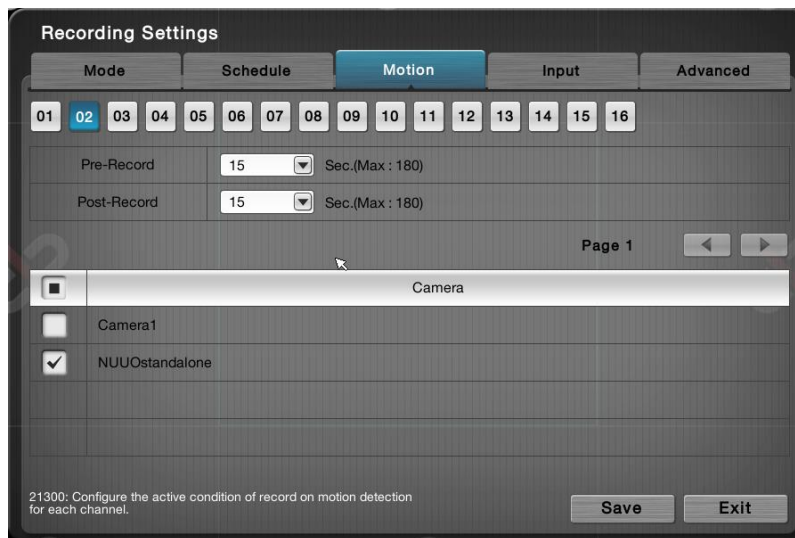

On the **Motion** tab, the featured settings are:

Setting	Description	Default
01 02 03 04	Selects a camera channel to configure.	01
Pre-Record	Sets the time to start recording right before the event of video motion occurred.	15 sec.
Post-Record	Sets the time to keep recording after the video motion stops.	15 sec.
Camera	Defines which camera’s motion detection to associate with this channel of camera to start recording.	--



Click the **Save** button to apply the change(s).

Click the **Exit** button to quit the tab.

6.2.1.4 Input tab

The **Input** tab helps users set the pre- and post-recording time upon the triggering of digital input.



To access the **Input** tab:

On the **Live View** screen, click menu list button  > **Main Menu** button  > **Recording & Event** button  > **Recording Settings** button > **Input** tab.

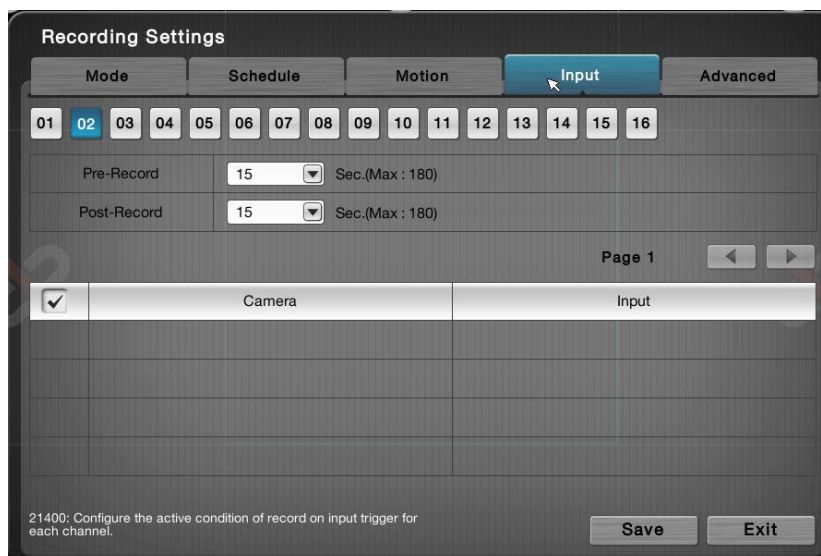
The **Input** tab then opens



On the **Input** tab, the featured settings are:

Setting	Description	Default
	Selects a camera channel to configure.	 (Channel 01)
Pre-Record	Sets the time to start recording right before the event of digital input occurred.	15 sec.
Post-Record	Sets the time to keep recording after the digital input stops	15 sec.
Input	Defines which input triggering to associate with this channel of camera to start recording.	--

Click the **Save** button to apply the change(s).

Click the **Exit** button to quit the tab.

6.2.1.5 Advanced tab

Advanced function can enable 2nd stream record – dual record, and this stream only support for always record that cannot use other records such as record on schedule, record on event.

Disable watermark checksum, which will save CPU loading but lead verification tool failed.

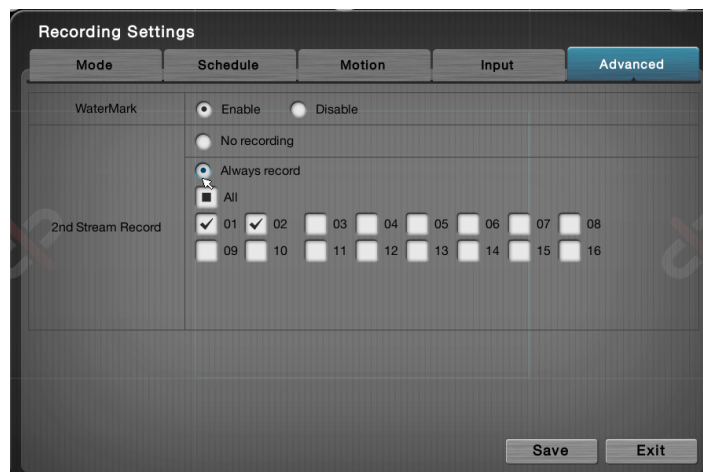

6.2.2 Event & Action

The **Event & Action** submenu enables/disables the event(s) that will lead action(s) from the server (system).

To access the **Event & Action** submenu:

Open **Recording & Event** menu as described in [Event & Action](#).

The **Recording & Event** menu opens.

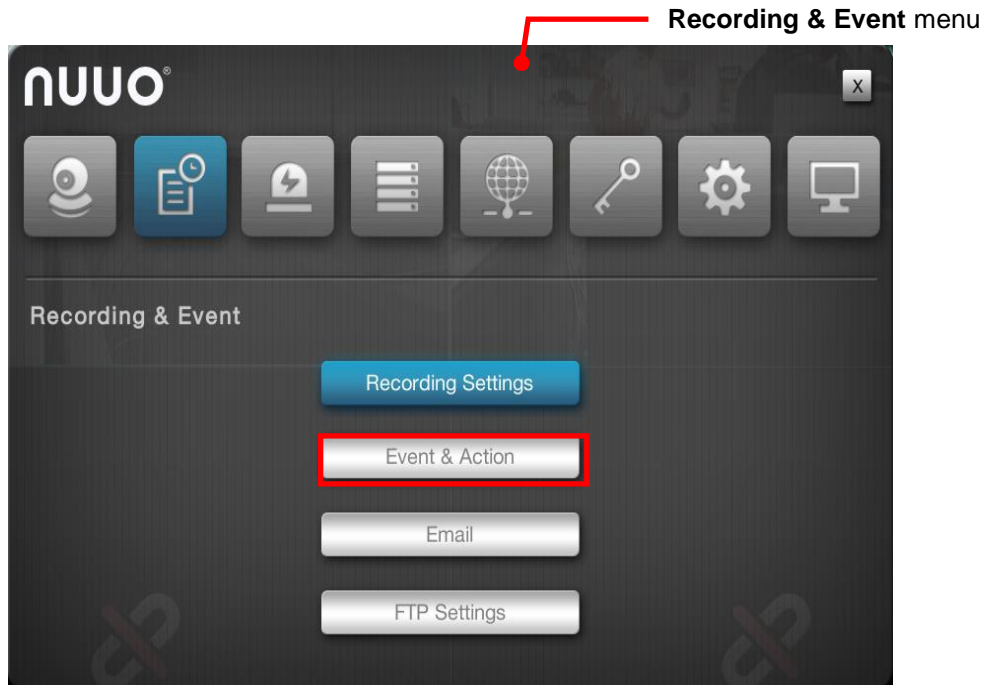

Click **Event & Action** button.

The **Event & Action** submenu opens and shows the **Camera** tab.

Event & Action submenu features three tabs: **Camera**, **Camera I/O** and **System**, which are detailed in the following of this section.

6.2.2.1 Camera

The **Camera** tab enables/disables the event(s) & action(s) for the camera conditions such as video motion detection and disconnection from the server.

To access the **Camera** tab:





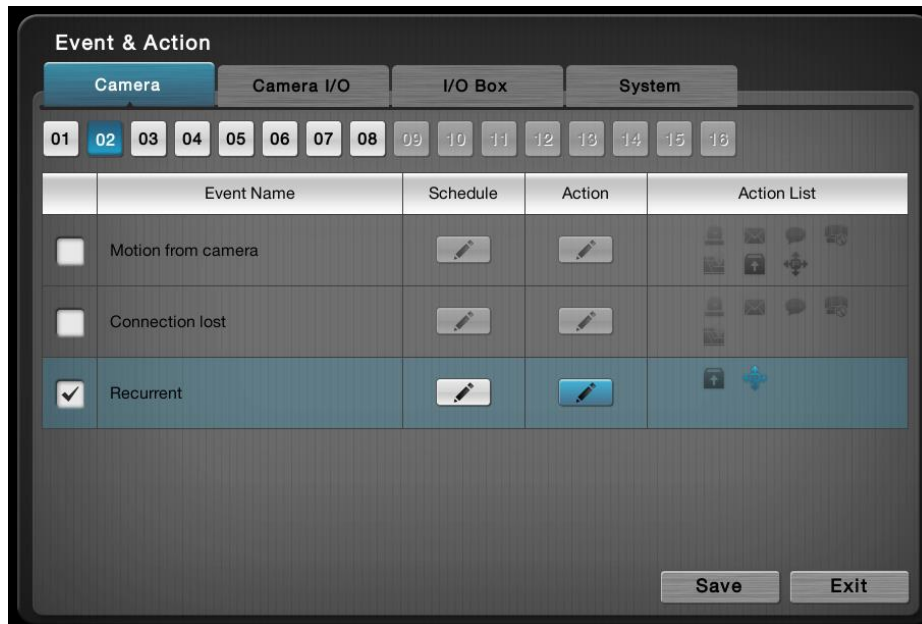

On the **Live View** screen, click menu list button  > **Main Menu** button 











> **Recording & Event** button  > **Event & Action** button > **Camera** tab.

The **Camera** tab then opens



On the **Camera** tab, the featured settings are:

Setting	Description	Default	
	Selects a camera channel to configure.		
Motion from camera	Enables/disables the system's action(s) when video motion is detected. <ul style="list-style-type: none"> ▶ If you wish to use motion detection by NVR, please ensure the Motion(NVR) is checked and set up in Camera Settings. ▶ If you wish to use motion detection by camera, please ensure the camera's video motion detection is enabled on camera web. 	Deselected (Disabled)	
Connection lost	Enables/disables the system's action(s) when it detects disconnection from the camera.	Deselected (Disabled)	
Recurrent	Enables/disables the recurrent event.	Deselected (Disabled)	
Schedule button 	Defines a time period to keep the event & action active. <ul style="list-style-type: none"> ▶ Once an event is enabled, the event (& action) is active from 00:00 through 23:59 by default. 	--	
Action button 	 Output	When an event occurs, the system will send an output signal to other connected devices. <ul style="list-style-type: none"> ▶ Once selected, a Detail dialog opens for users to set which output pin to send the output signal through. 	Deselected (Disabled)
	 Email	When an event occurs, the system will send Email notifications. Make sure to add an Email address first. <ul style="list-style-type: none"> ▶ To set up the Email(s) to receive notifications, see Email. ▶ Once selected, its Detail dialog opens for Email 	Deselected (Disabled)

		selection.	
	 push notification	When an event occurs, the system will send instant message to the registered mobile clients as a notification. Mobile users can check the recording videos on mobile client to watch what just happened. ▶ See Push Notification for details. ▶ Once selected, its Detail dialog opens for user selection.	Deselected (Disabled)
	 CMS	When an event occurs, the system will send out a signal to CMS. CMS will highlight this event. ▶ You may choose whether sending with snapshot or not.	Deselected (Disabled)
	 E-map popup (remote)	When an event occurs, the system will pop up E-map with an event indicator to show users the location of the scene clearly.	Deselected (Disabled)
	 Snapshot to FTP	When an event occurs, the system will upload snapshots to FTP.	Deselected (Disabled)
Details button 	 Output	Opens a dialog for output pin selection. ▶ See Device for detailed device I/O pin setting.	--
	 Email	Opens a dialog for Email selection. ▶ See Email to set up the email(s) to receive notifications. ▶ You may choose whether sending Email with snapshot or not.	--
	 push notification	Opens a dialog for interval settings and user selection. ▶ See Push Notification for details. ▶ See User Management to set up the user(s) to receive notifications.	--
	 CMS	Opens a dialog for CMS selection. ▶ You may choose whether sending with snapshot or not.	--
	 Snapshot to FTP	Opens a dialog for snapshot to FTP selection. ▶ You may configure how and when you want to stop sending. ▶ You may configure the frame interval.	--
	 PTZ preset go	Opens a dialog for the PTZ preset go or patrol configuration ▶ You may configure how and when you want to Start PTZ preset point . ▶ You may configure the Life Cycle of PTZ .	

 The availability of event options depends on the camera's feature.

Click the **Save** button to apply the change(s).

Click the **Exit** button to quit the tab.

6.2.2.2 Camera I/O

The **Camera I/O** tab enables/disables the event(s) & action(s) for the digital inputs/outputs detected through one or more of the camera's input pins.

To access the **Camera I/O** tab:





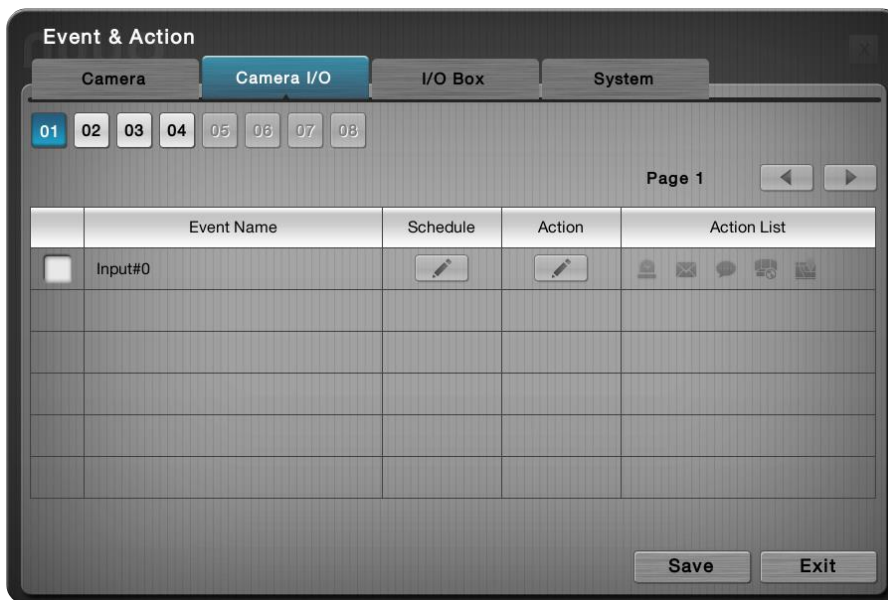

On the **Live View** screen, click menu list button  > **Main Menu** button 







> **Recording & Event** button  > **Event & Action** button > **Camera I/O** tab.

The **Camera I/O** tab then opens



On the **Camera I/O** tab, the featured settings are:

Setting	Description	Default	
	Selects a camera channel to configure.		
Input#0	Enables/disables the system's action(s) when an external input is detected through the camera's input pin(s).	Deselected (Disabled)	
Input#1			
Schedule button 	Defines a time period to keep the event & action active. ▶ Once an event is enabled, the event (& action) is active from 00:00 through 23:59 by default.	The event (& action) is active from 00:00 through 23:59.	
Action 	 Output	When an event occurs, the system will send an output signal to other connected devices. ▶ Once selected, a Detail dialog opens for users to set which output pin to send the output signal through.	Deselected (Disabled)
	 Email	When an event occurs, the system will send Email notifications. Make sure to add an Email address first. ▶ To set up the Email(s) to receive notifications, see	Deselected (Disabled)



		Email . ▶ Once selected, its Detail dialog opens for Email selection.	
	 push notification	When an event occurs, the system will send instant message to the registered mobile clients as a notification. Mobile users can check the recording videos on mobile client to watch what just happened. ▶ See Push Notification for details. ▶ Once selected, its Detail dialog opens for user selection.	Deselected (Disabled)
	 CMS	When an event occurs, the system will send out a signal to CMS. CMS will highlight this event.	Deselected (Disabled)
	 E-map popup (remote)	When an event occurs, the system will pop up E-map with an event indicator to show users the location of the scene clearly.	Deselected (Disabled)
Details button 	 Output	Opens a dialog for output pin selection. ▶ See Device for detailed device I/O pin setting.	--
	 Email	Opens a dialog for Email selection. ▶ See Email to set up the email(s) to receive notifications.	--
	 push notification	Opens a dialog for user selection. ▶ See Push Notification for details. ▶ See User Management to set up the user(s) to receive notifications.	--

	The availability of input pins depends on the camera's feature.
--	---

6.2.2.3 I/O Box

The **I/O Box** tab enables/disables the event(s) & action(s) for the digital inputs/outputs detected through one or more of the remote I/O box's input pins and on-box I/O's input pins. On-box I/O is supported by 8 bay unit only.

To access the **I/O Box** tab:



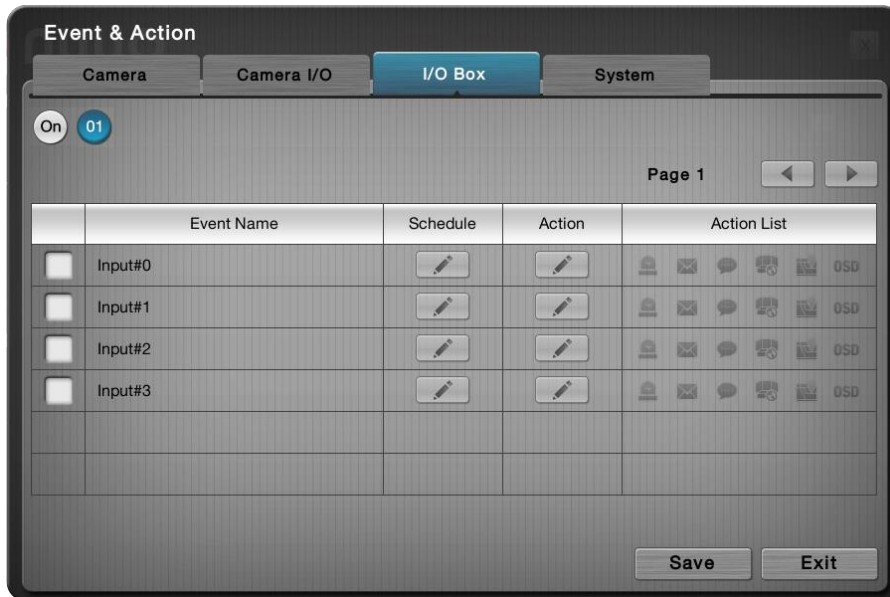

On the **Live View** screen, click menu list button  > **Main Menu** button 
> **Recording & Event** button  > **Event & Action** button > **I/O Box** tab.

The **I/O Box** tab then opens



On the **I/O Box** tab, the featured settings are:

Setting	Description	Default
	Selects the on-box I/O or an I/O box to configure.	: 8bay : 1bay
Input#0	Enables/disables the system's action(s) when an external input is detected through the I/O box's input pin(s).	Deselected (Disabled)
Input#1		
Schedule button 	Defines a time period to keep the event & action active. <ul style="list-style-type: none"> Once an event is enabled, the event (& action) is active from 00:00 through 23:59 by default. 	The event (& action) is active from 00:00 through 23:59.
Action 	Output <ul style="list-style-type: none"> When an event occurs, the system will send an output signal to other connected devices. Once selected, a Detail dialog opens for users to set which output pin to send the output signal through. 	Deselected (Disabled)
	Email <ul style="list-style-type: none"> When an event occurs, the system will send Email notifications. Make sure to add an Email address first. To set up the Email(s) to receive notifications, see Email. Once selected, its Detail dialog opens for Email selection. 	Deselected (Disabled)
	push notification <ul style="list-style-type: none"> When an event occurs, the system will send instant message to the registered mobile clients as a notification. Mobile users can check the recording videos on mobile client to watch what just happened. See Push Notification for details. Once selected, its Detail dialog opens for user selection. 	Deselected (Disabled)
	CMS <ul style="list-style-type: none"> When an event occurs, the system will send out a signal to CMS. CMS will highlight this event. 	Deselected (Disabled)
	E-map popup <ul style="list-style-type: none"> When an event occurs, the system will pop up E-map with an event indicator to show users the location of the scene clearly. 	Deselected (Disabled)



	(remote)		
	 On screen display	When an event occurs, the system will show an alert message on selected camera(s) of screen.	Deselected (Disabled)
Details button 	 Output	Opens a dialog for output pin selection. ▶ See Device for detailed device I/O pin setting.	--
	 Email	Opens a dialog for Email selection. ▶ See Email to set up the email(s) to receive notifications.	--
	 push notification	Opens a dialog for user selection. ▶ See Push Notification for details. ▶ See User Management to set up the user(s) to receive notifications.	--

 The availability of input pins of remote I/O box depends on models.

6.2.2.4 System

The **System** tab enables/disables the event(s) & action(s) for some system abnormalities.











To access the **System** tab:

On the **Live View** screen, click menu list button  > **Main Menu** button 
 > **Recording & Event** button  > **Event & Action** button > **System** tab.

The **System** tab then opens



On the **System** tab, the featured settings are:

Setting	Description	Default	
Abnormal disk status	Enables/disables the system's action(s) when there is no enough disk space for recording or when disk accessing goes wrong.	Deselected (Disabled)	
Daily system report	Enables/disables the system sending notification(s) daily to one or more Email(s) about the system's HDD usage.	Deselected (Disabled)	
Unable to access FTP	Enables/disables the system sending notification(s) to one or more Emails when the system loses the connection with the FTP server for auto-backup.	Deselected (Disabled)	
Backup unfinished	Enables/disables the system sending notification(s) to one or more Emails when the system cannot complete the process of auto-backup. <ul style="list-style-type: none"> The Email(s) sent will list the name(s) of the file(s) in question after the system finishes the backup of the very last file scheduled. 	Deselected (Disabled)	
Power-on notification	Enables/disables recording the time when the system is powered on after the power resumes from an abnormal shutdown.	Deselected (Disabled)	
System overheating	Enables/disables sending notification(s) to one or more Email(s) once the system gets overheated and auto powers off.	Deselected (Disabled)	
Schedule button 	For every system event, it isn't available to set a time period to keep the event active. A system event (& action) stays active from 00:00 through 23:59 once it is enabled,	The event (& action) is active from 00:00 through 23:59.	
Action 	 Output	When an event occurs, the system will send an output signal to other connected devices. <ul style="list-style-type: none"> Once selected, a Detail dialog opens for users to set which output pin to send the output signal through. 	Deselected (Disabled)
	 Email	When an event occurs, the system will send Email notifications. Make sure to add an Email address first. <ul style="list-style-type: none"> To set up the Email(s) to receive notifications, see Email. Once selected, its Detail dialog opens for Email selection. 	Deselected (Disabled)
	 push notification	When an event occurs, the system will send instant message to the registered mobile clients as a notification. Mobile users can check the recording videos on mobile client to watch what just happened. <ul style="list-style-type: none"> See Push Notification for details. Once selected, its Detail dialog opens for user selection. 	Deselected (Disabled)
	 CMS	When an event occurs, the system will send out a signal to CMS. CMS will highlight this event.	Deselected (Disabled)
	 E-map popup (remote)	When an event occurs, the system will pop up E-map with an event indicator to show users the location of the scene clearly.	Deselected (Disabled)
Details button 	 Output	Opens a dialog for output pin selection. <ul style="list-style-type: none"> See Device for detailed device I/O pin setting. 	--
	 Email	Opens a dialog for Email selection. <ul style="list-style-type: none"> See Email to set up the email(s) to receive notifications. 	--

	 push notification	Opens a dialog for user selection. ▶ See Push Notification for details. ▶ See User Management to set up the user(s) to receive notifications.	--
--	---	---	----

Click the **Save** button to apply the change(s).

Click the **Exit** button to quit the tab.

6.2.2.5 Push Notification

When an event occurs, the system will send instant message to the registered mobile clients as a notification. Mobile users can check the recording videos on mobile client to watch what just happened, which saves users' time in full time monitoring.

On the **Live View** screen, click menu list button  > **Main Menu** button 
 > **Recording & Event** button  > **Event & Action** button.

Add **Push Notification** as a responding action for an event. Configure the rearm interval and assign user(s).

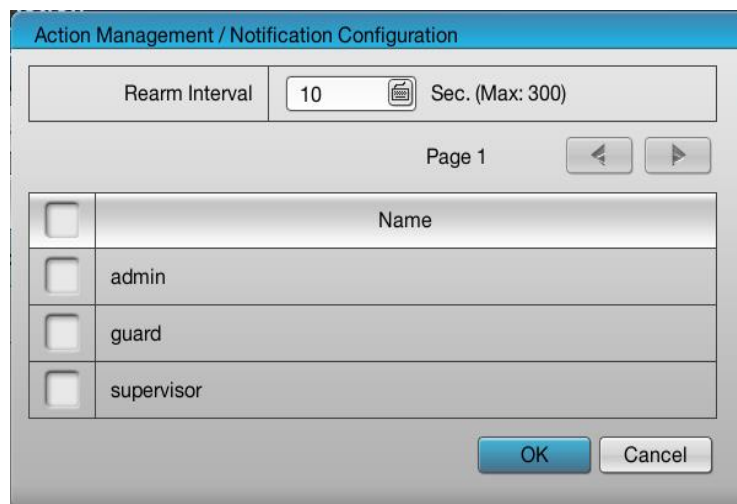



Setting	Description	Default
Rearm Interval	The minimum interval of notifications as the event occurs. For example, you set up push notification as the responding action for motion detection. When motion detected, it may trigger several alarms. In this case, you may not want to receive several push notifications frequently, then you can define the suitable rearm interval.	10 Sec. (Max: 300)
User List	All user accounts configured in this unit display on	Deselected

	the list. Select user(s) to receive notifications. ▶ See User Management to set up users.	(Disabled)
--	--	------------

Sign in the unit on NUUO mobile client with the user account assigned with push notification service.

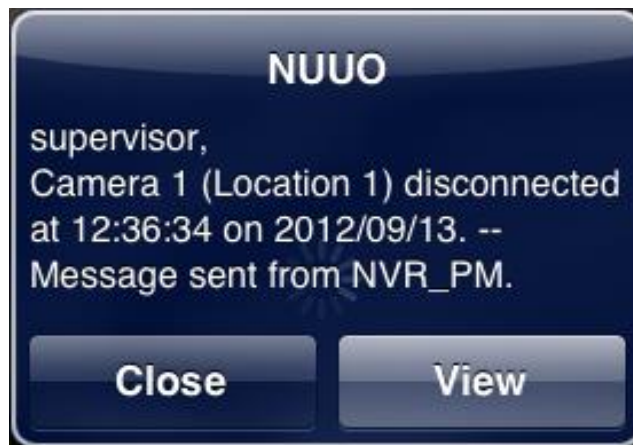
When an event occurs, the user will get the push notification instantly. The user can click the "View" icon to watch the recording videos.



	If the user password is changed, please sign in with the new password to start the service again.
---	---

	If users don't want to receive notifications anymore, users can turn off this feature on NUUO mobile client. There is one possibility of de-registering failed, that is, users have ever logged in to the mobile client by typing both LAN IP and WAN IP of the NVR, but only do de-registering on one side.
---	---

	If users don't want to send notifications to certain user account, users can de-select the user account in Event & Action Management page.
---	---

	User account won't be exported as saving configuration, which implies the user list of push notification won't be saved as well.
---	--

6.2.3 Email

The **Email** submenu sets up the Emails to receive the notifications sent by the (server) system for the configured camera events, input events and system events. It also manages the SMTP server for outgoing Emails.

To access the **Email** submenu:

Open **Recording & Event** menu as described in [Event & Action](#).

The **Recording & Event** menu opens.



Click **Email** button.

The **Email** submenu opens and shows the **Contact** tab.

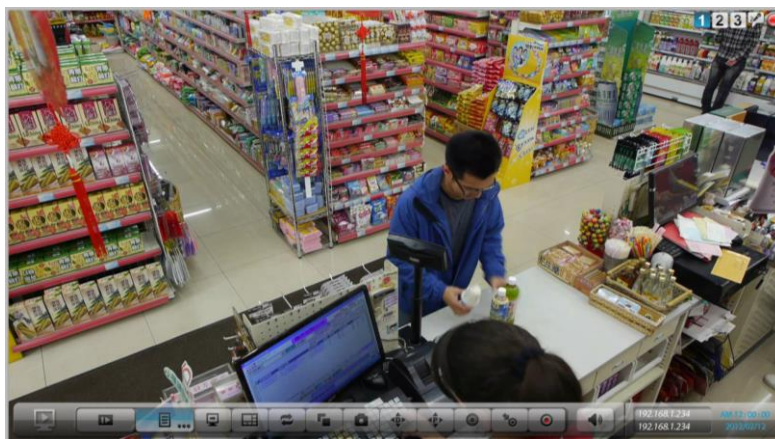
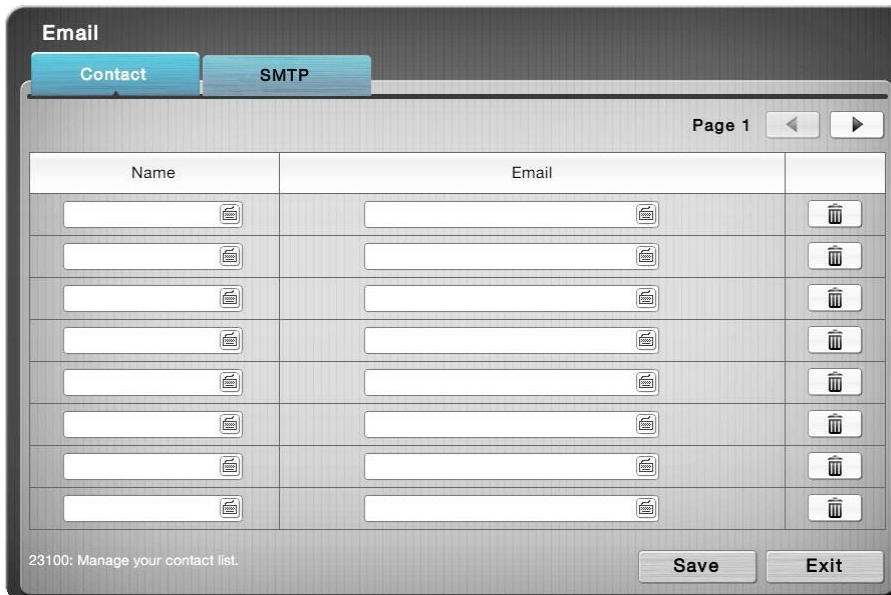



Email setting features two tabs: **Contact** and **SMTP**, which are detailed in the following of this section.

6.2.3.1 Contact

The **Contact** tab sets up the Emails to receive the notifications sent by the system. Up to 40 contacts are supported.



To access the **Contact** tab:

On the **Live View** screen, click menu list button  > **Main Menu** button 
 > **Recording & Event** button  > **Email** button > **Contact** tab.

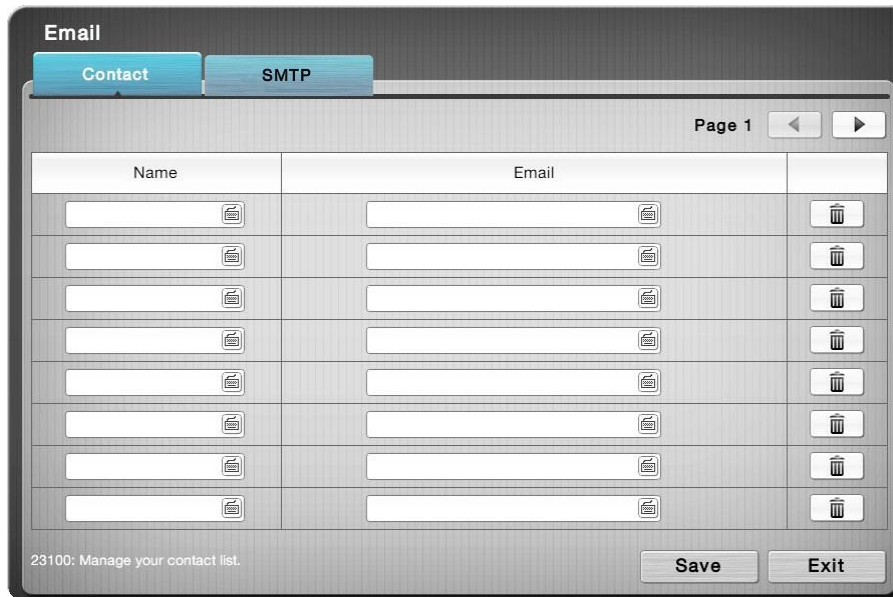
The **Contact** tab then opens



On the **Contact** tab, the featured settings are:

Setting	Description	Default
Name	Sets up an identity for the Email. <ul style="list-style-type: none"> Click the keyboard icon  at the right of the field to open the virtual keyboard for name input. 	--
Email	Inputs the email address. <ul style="list-style-type: none"> Click the keyboard icon  at the right of the field to open the virtual keyboard for Email address input. 	--
Delete button 	Deletes the Email from the contact list.	--



Click the **Save** button to apply the change(s).

Click the **Exit** button to quit the tab.

6.2.3.2 SMTP

The **SMTP** tab sets up the “Simple Mail Transfer Protocol” for the system to send out Emails.



To access the **SMTP** tab:



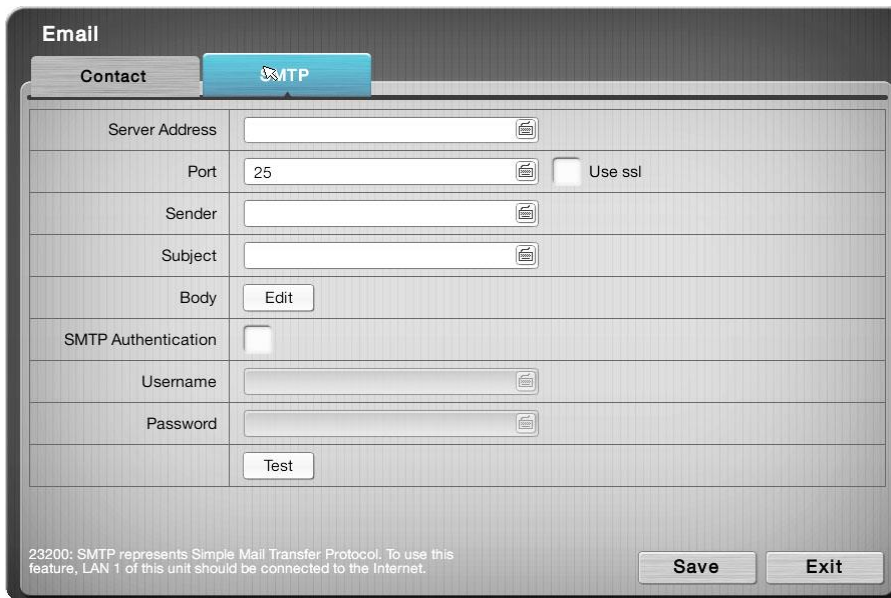

On the **Live View** screen, click menu list button  > **Main Menu** button 
> **Recording & Event** button  > **Email** button > **SMTP** tab.

The **SMTP** tab then opens



On the **SMTP** tab, the featured settings are:

Setting	Description	Default
Server address	Enters the SMTP server’s IP address or server name. ▶ Click the keyboard icon  at the right of the field to open the virtual keyboard for text input.	--
Port	Assigns the port number. ▶ Click the keyboard icon  at the right of the field to open the virtual keyboard for text input.	25
Use ssl	Enables/disables Secure Sockets Layer.	Deselected

		(Disabled)
Sender	Enters the sender's Email address. ▶ Click the keyboard icon  at the right of the field to open the virtual keyboard for text input.	--
Subject	Defines a subject for all the Emails sent. ▶ Click the keyboard icon  at the right of the field to open the virtual keyboard for text input.	--
Body	Defines Email content. Press [Shift+Enter] to go to next line when input content.	
SMTP Authentication	Enables/disables the username/password authentication before an Email is sent.	Deselected (Disabled)
Username	Sets up the username for SMTP authentication. ▶ Click the keyboard icon  at the right of the field to open the virtual keyboard for text input.	--
Password	Sets up the password for SMTP authentication. ▶ Click the keyboard icon  at the right of the field to open the virtual keyboard for text input.	--
Test button	Makes the system send a test Email to the sender to make sure the function works.	--

Click the **Save** button to apply the change(s).

Click the **Exit** button to quit the tab.

6.2.4 FTP Settings

The **FTP Settings** submenu helps users set the FTP server to save the backup data and snapshots to.

To access the **FTP Settings** submenu:

Open **Recording & Event** menu as described in [Event & Action](#).

The **Recording & Event** menu opens.



Click **FTP Settings** button.

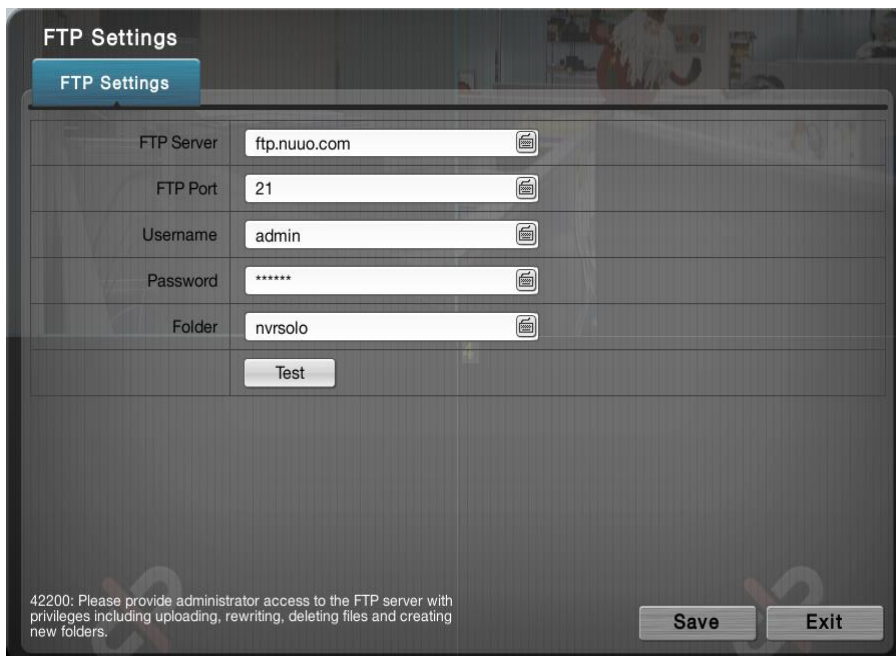





The image shows a screenshot of the "FTP Settings" configuration window. The window has a title bar that says "FTP Settings" and a tab labeled "FTP Settings". Below the title bar, there are five input fields, each with a small document icon to its right:

FTP Server	ftp.nuuo.com
FTP Port	21
Username	admin
Password	*****
Folder	nvrsole

Below these fields is a "Test" button. At the bottom of the window, there are "Save" and "Exit" buttons. A small note at the bottom left reads: "42200: Please provide administrator access to the FTP server with privileges including uploading, rewriting, deleting files and creating new folders."

On the **FTP Settings** tab, the featured settings are:

Setting	Description	Default
FTP Server	<p>Sets the IP address or server name of the backup server.</p> <ul style="list-style-type: none"> ▶ Click the keyboard icon  at the right of the field to open the virtual keyboard for text input. 	--
FTP Port	Sets the port number of the backup server.	21
Username	<p>Enters the username to log in the backup server.</p> <ul style="list-style-type: none"> ▶ Click the keyboard icon  at the right of the field to open the virtual keyboard for text input. 	--
Password	<p>Enters the password to log in the backup server.</p> <ul style="list-style-type: none"> ▶ Click the keyboard icon  at the right of the field to open the virtual keyboard for text input. 	--
Folder	<p>Specifies the folder to save the backup data to.</p> <ul style="list-style-type: none"> ▶ The folder name should be the format of "FolderName", "FolderName/SubFolderName" and so on. ▶ Click the keyboard icon  at the right of the field to open the virtual keyboard for text input. 	--
Test	Runs a test on the configuration by making the system create a folder onto the configured FTP server.	--

Click the **Save** button to apply the change(s).

Click the **Exit** button to quit the tab.

6.3 Device

The menu **Device** manages the inputs and outputs of camera, remote I/O box and on-box I/O. Only 8 bay unit supports on-box I/O.

To access the **Device** menu:

Open the **Main Menu** as described in [Settings](#)

The **Main Menu** opens.

Click **Device** button .

The **Device** menu opens.

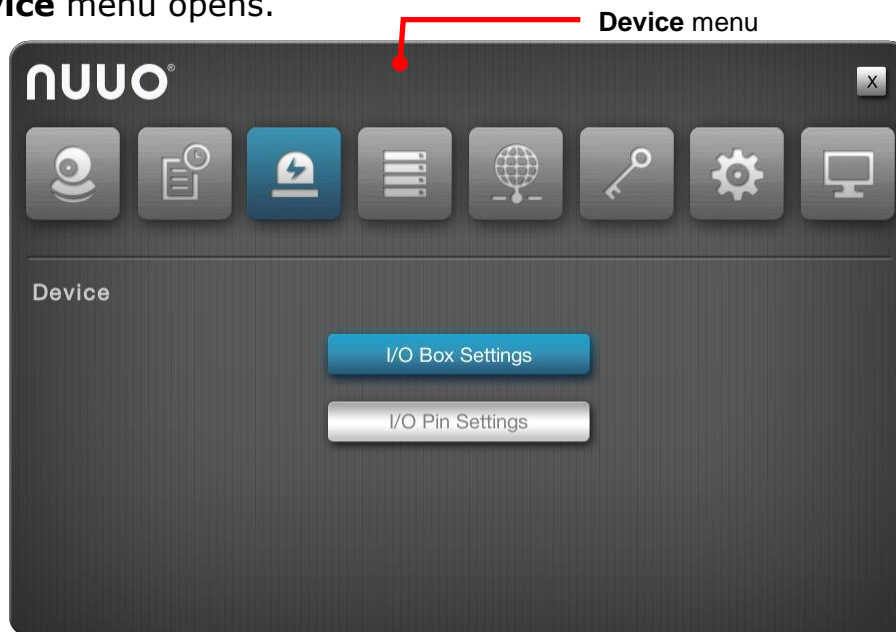

The **Device** menu features the submenus **I/O Box Settings** and **I/O Pin Settings**, which are explicated in the following of this section.

6.3.1 I/O Box Settings

The submenu **I/O Box Settings** configures the remote I/O box to do the further input/output settings.

To access the **I/O Box Settings** submenu:

Open **Device** menu as described in [Device](#).

The **Device** menu opens.

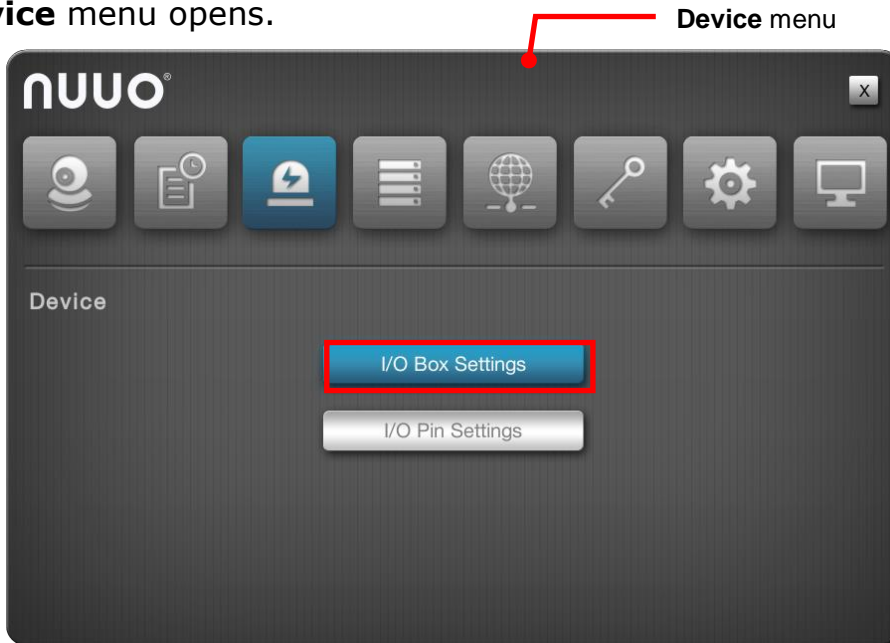

Click **I/O Box Settings** button.

The **I/O Box Settings** submenu opens and shows the **Information** tab.

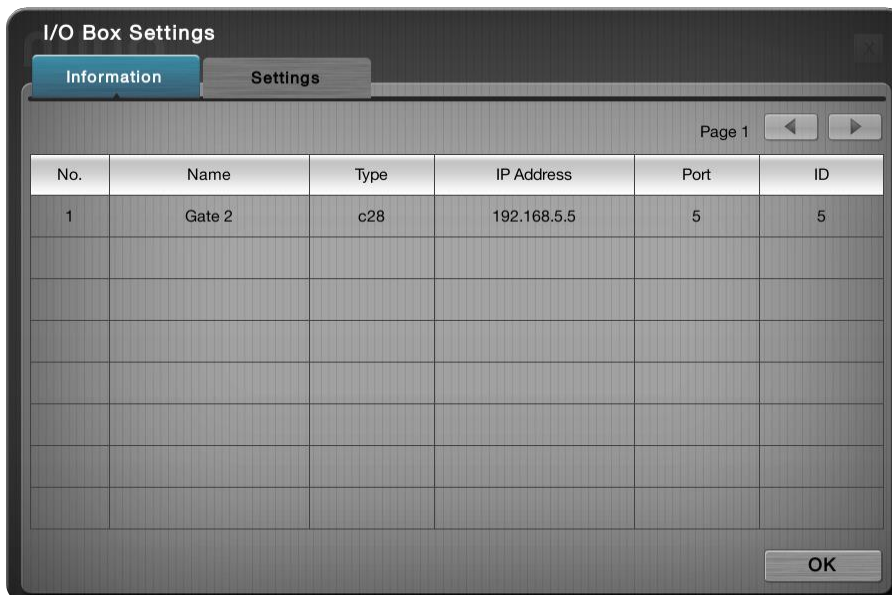



I/O Box Settings features two tabs **Information** and **Settings**, which are

detailed in the following of this section.

6.3.1.1 Information

The **Information** tab shows the current configuration overview of remote I/O box.

To access the **Information** tab:

On the **Live View** screen, click menu list button  > **Main Menu** button 
> **Device** button  > **I/O Box Settings** button > **Information** tab.

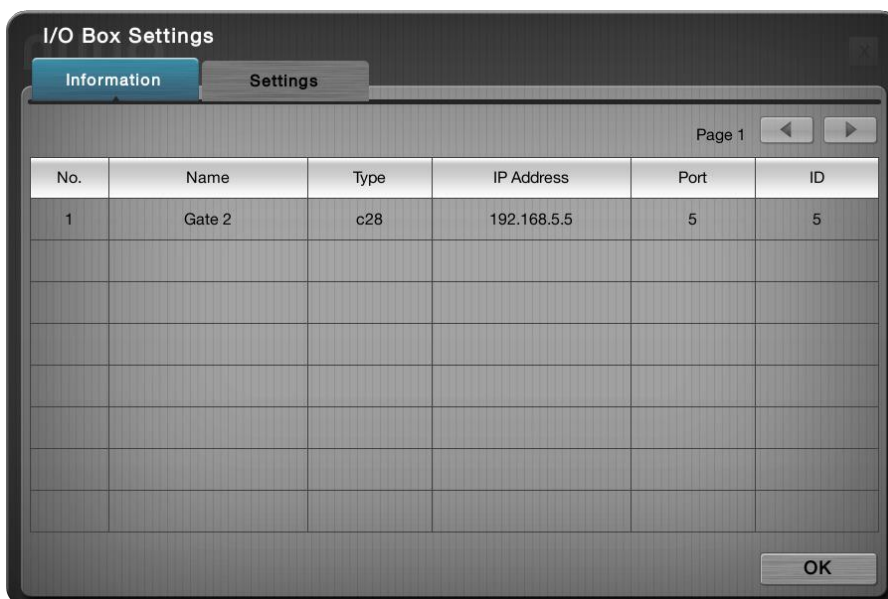



Click the **OK** button to quit the tab.

6.3.1.2 Settings

The **Settings** tab enables users to configure remote I/O box to do the further input/output settings.







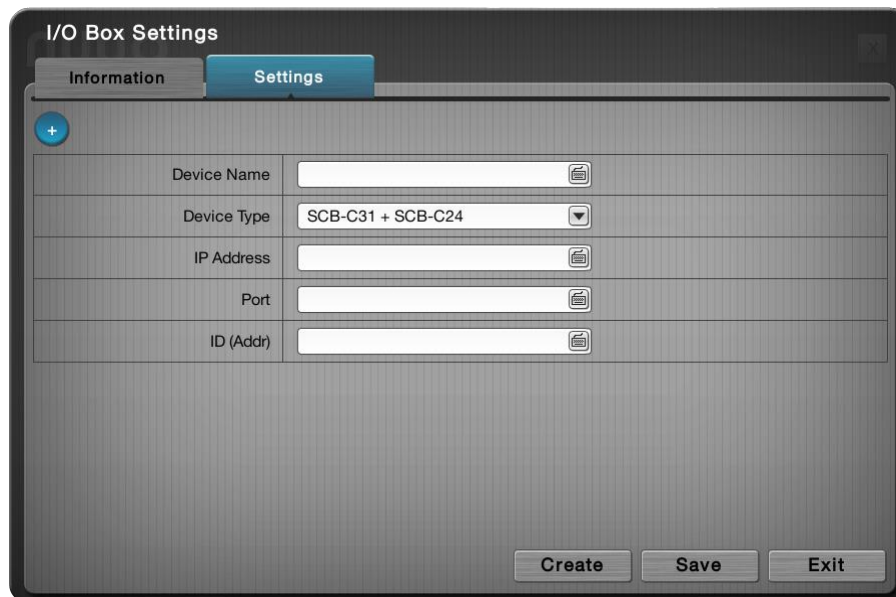

To access the **Settings** tab:

On the **Live View** screen, click menu list button  > **Main Menu** button 
> **Device** button  > **I/O Box Settings** button > **Settings** tab.

The **Settings** tab opens.



On the **Settings** tab, the featured settings are:

Setting	Description	Default
 	Selects the  button to create remote I/O box. For the configured I/O box, selects number directly to modify, e.g. 	
Device Type	Selects the types of I/O boxes, which owns different numbers of input pins and output.	SCB-C31 + SCB-C24
IP Address	Sets the SCB-C31's IP address. ▶ Click the keyboard icon  at the right of the field to open the virtual keyboard for text input.	--
Port	Sets the SCB-C31's port number. ▶ Click the keyboard icon  at the right of the field to open the virtual keyboard for text input.	--
ID	Sets the I/O box's ID. ▶ Click the keyboard icon  at the right of the field to open the virtual keyboard for text input.	--

Click the **Create** button to create I/O box.

Click the **Save** button to apply the change(s).

Click the **Exit** button to quit the tab.

6.3.2 I/O Pin Settings

The submenu **I/O Pin Settings** manages the input pins and output pins of the cameras connected on the same subnet.

To access the **I/O Pin Settings** submenu:

Open **Device** menu as described in [Device](#).

The **Device** menu opens.

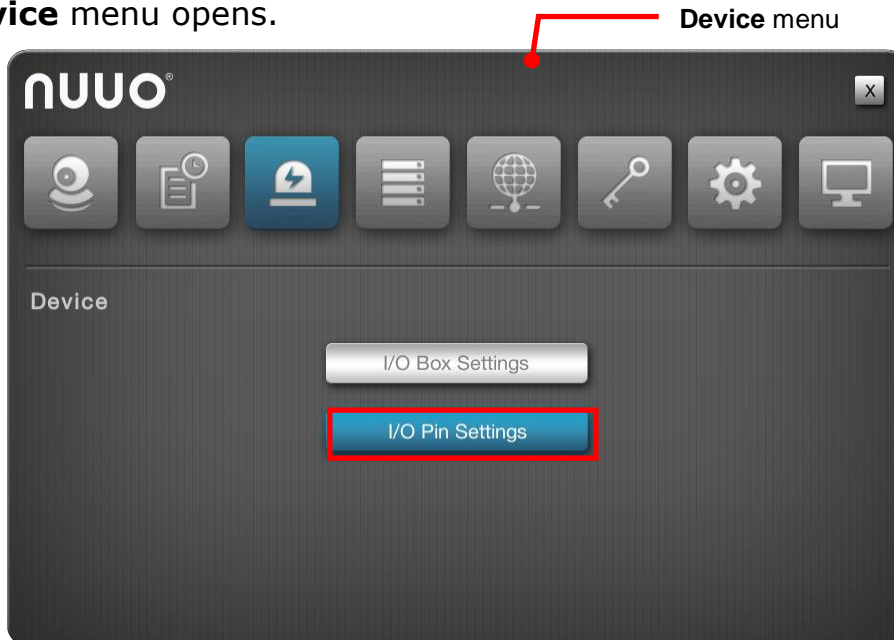

Click **I/O Pin Settings** button.

The **I/O Pin Settings** submenu opens and shows the **Camera I/O** tab.

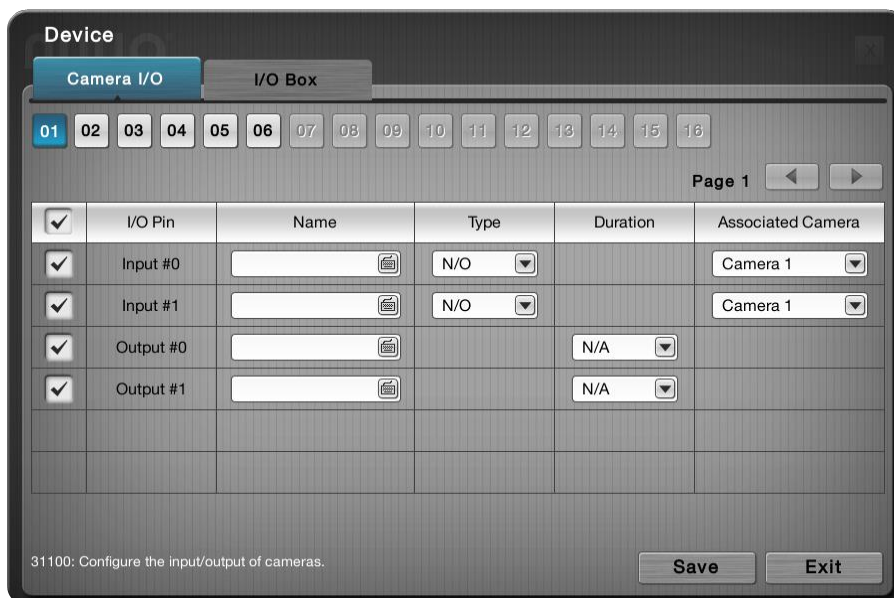



I/O Pin Settings features two tabs: **Camera I/O** and **I/O Box**, which are

detailed in the following of this section.

6.3.2.1 Camera I/O

The **Camera I/O** tab manages the input pins and output pins of the cameras.



To access the **Camera I/O** tab:

On the **Live View** screen, click menu list button  > **Main Menu** button  > **Device** button  > **I/O Pin Settings** button > **Camera I/O** tab.

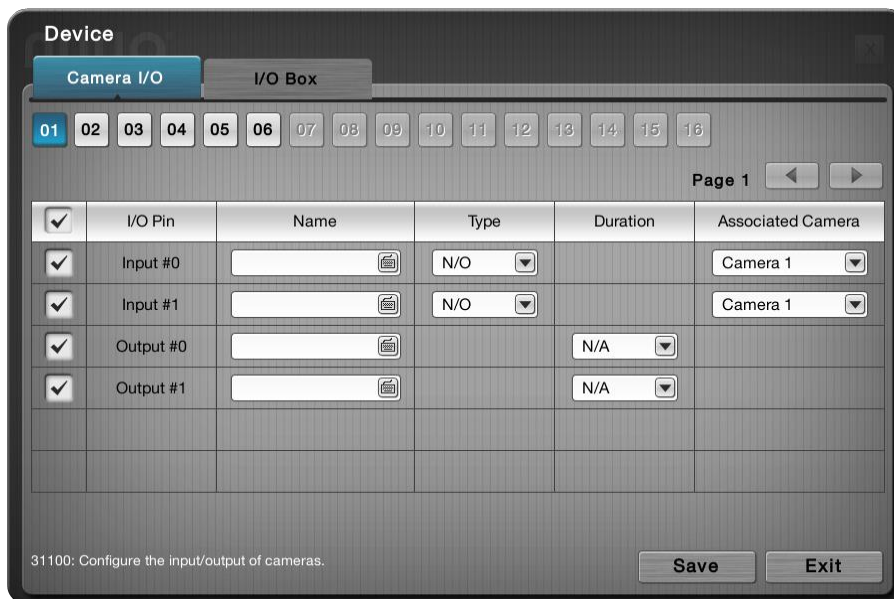
The **Camera I/O** tab opens and shows the available input pins and output pins of the camera(s).



On the **Camera I/O** tab, the featured settings are:

Setting	Description	Default
	Selects a camera channel to configure.	
I/O Pin	Enables/disables an I/O pin.	Selected (Enabled)
Name	Enters a name or info about the I/O pin. <ul style="list-style-type: none"> Click the keyboard icon  at the right of the field to open the virtual keyboard for name input. 	--
Type	Sets I/O type for the I/O pin. <ul style="list-style-type: none"> N/O means normally open. N/C means normally close. 	N/O (normally open)

Duration	Defines the time to keep an output active after it is triggered.	N/A (The output stays active unless it is manually switched off.)
Associated Camera	Selects an associated camera for input pin, which will be the communication media for server and client. (e.g. when an input was triggered and pushed a notification to mobile, users can playback the videos of its associated camera.)	Itself



Click the **Save** button to apply the change(s).

Click the **Exit** button to quit the tab.

6.3.2.2 I/O Box

The **I/O Box** tab manages the input pins and output pins of the I/O box and on-box I/O.



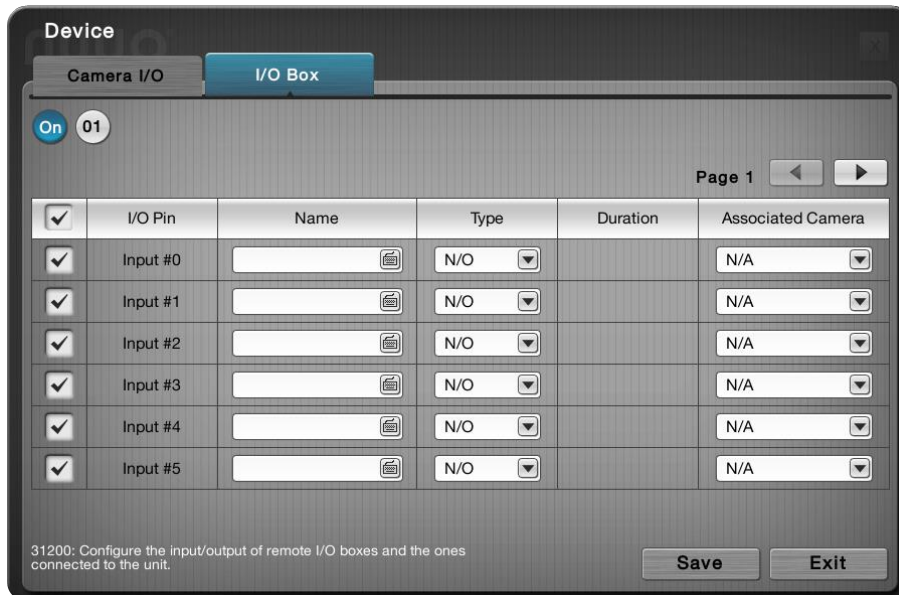

To access the **I/O Box** tab:

On the **Live View** screen, click menu list button  > **Main Menu** button 
 > **Device** button  > **I/O Pin Settings** button > **I/O Box** tab.

The **I/O Box** tab opens and shows the available input pins and output pins of the on-box I/O or I/O box. (On-box I/O is not supported in 1 bay unit, so only I/O box is available.)



On the **I/O Box** tab, the featured settings are:

Setting	Description	Default
 	Selects the on-box I/O or an I/O box to configure.	 : 8bay  : 1bay
I/O Pin	Enables/disables an I/O pin.	Selected (Enabled)
Name	Enters a name or info about the I/O pin. ▶ Click the keyboard icon  at the right of the field to open the virtual keyboard for name input.	--
Type	Sets I/O type for the I/O pin. ▶ N/O means normally open. N/C means normally close.	N/O (normally open)
Duration	Defines the time to keep an output active after it is triggered.	N/A (The output stays active unless it is manually switched off.)
Associated Camera	Selects an associated camera for input pin, which will be the communication media for server and client. (e.g. when an input was triggered and pushed a notification to mobile, users can playback the videos of its associated camera.)	N/A

Click the **Save** button to apply the change(s).

Click the **Exit** button to quit the tab.

6.4 Storage

Use the menu **Storage** to manage the system's storage and data backup.

To access the **Storage** menu:

Open the **Main Menu** as described in [Settings](#)

The **Main Menu** opens.

Click **Storage** button .

The **Storage** menu opens.

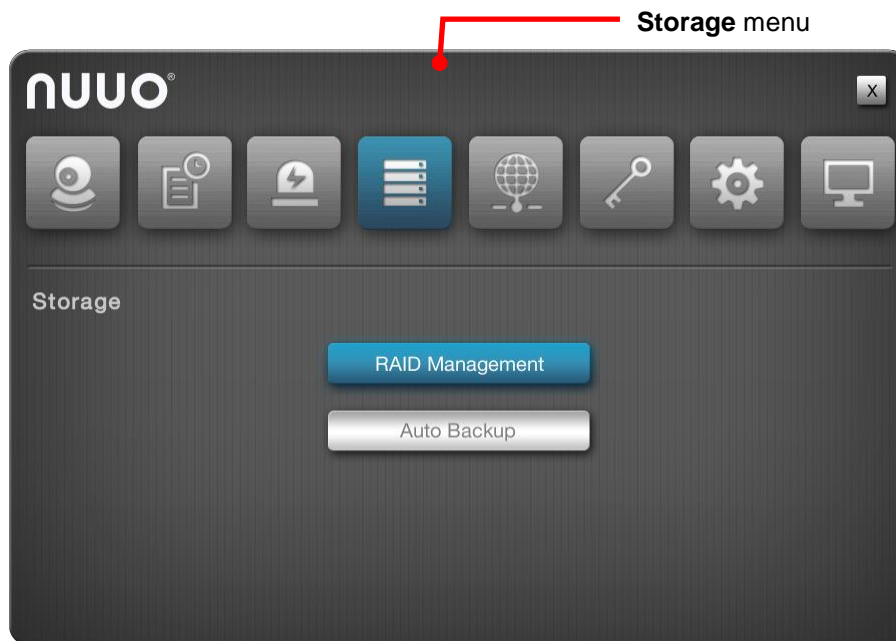

The **Storage** menu features two submenus, **RAID Management** and **Auto Backup**, which are explicated in the following of this section.

6.4.1 RAID Management

As the name suggest, the **RAID Management** submenu manages the system's RAID (Redundant Array of Independent Disks), a storage that combines multiple disk drives into a logical unit

To access the **RAID Management** submenu:

Open **Storage** menu as described in [Storage](#).

The **Storage** menu opens.

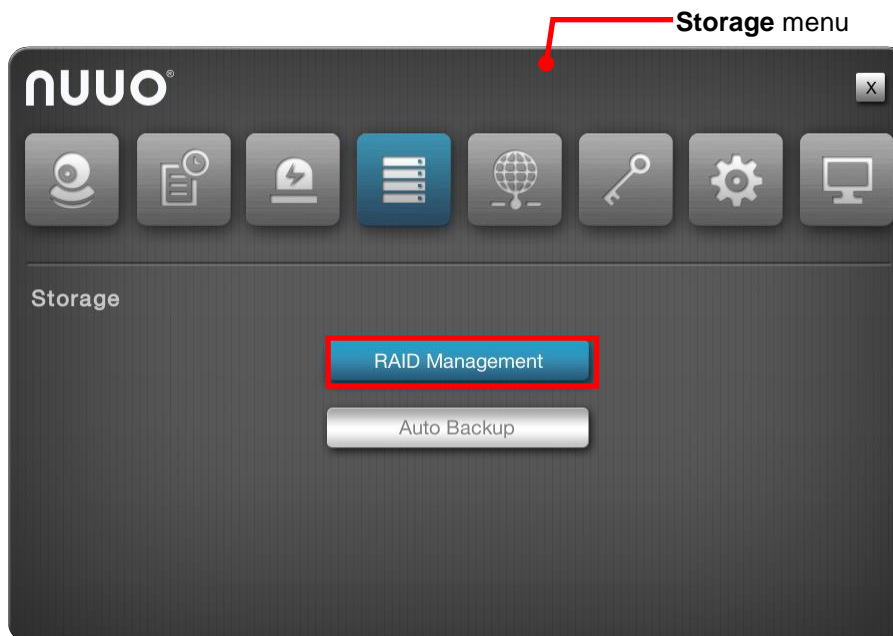

Click **RAID Management**.

The **RAID Management** submenu opens and shows the **Status** tab.

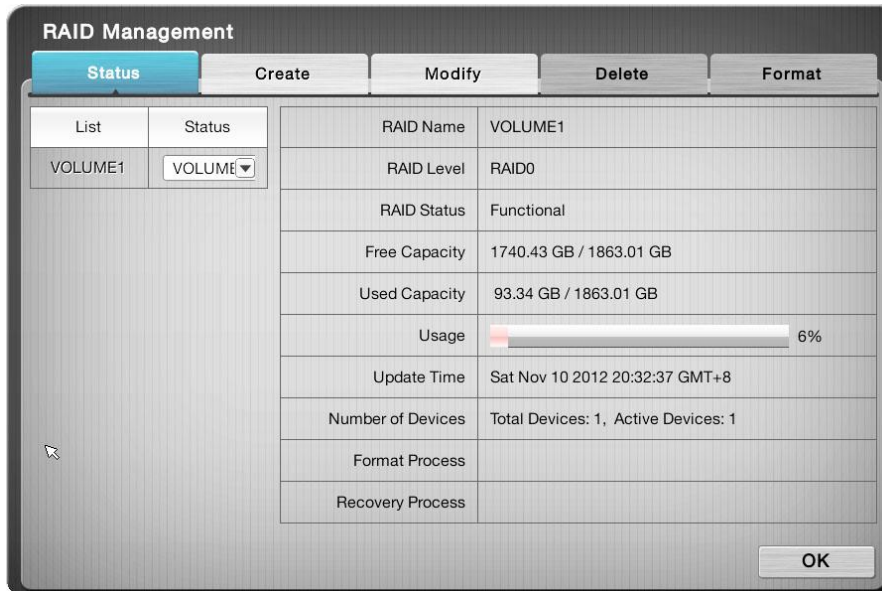



RAID Management features five tabs: **Status**, **Create**, **Modify**, **Delete** and **Format**, which are detailed in the following of this section.



 The RAID Volume will be functional on another unit if **all** disks of this volume are moved to the unit.

 After setting RAID level, you are not allowed to change neither the RAID level nor the number of disks containing in this volume.

 Separate embedded disk(s) and external disk (DAS) from two groups, which implies there is no way to create a single volume with both embedded and external disks inside.

 For 8-bay RAID model, when creating RAID volume, please note that HDD tray on top(HDD1,2,3,4) are 1 group, while bottom tray (HDD5,6,7,8) is another. For example, HDD1 and HDD4 can be created as 1 volume; while HDD1 and HDD5 cannot be created as 1 volume.



To reduce the possibility of having problems to access public folder via My Network Places, before creating new disk volume or modifying volume, please delete the invalid volume if any.



If you choose Express Mode when using the **Installation Wizard**, the disk(s) will be set to RAID 0 automatically unless the number of disks is not enough for this RAID level.



To make sure all the information of hard disk and RAID volume are correct, 8bay RAID model are not allowed to query status, create, modify, delete, format RAID volume when the front panel is opened.





Not support disk hot swap on external storage currently. Please reboot the unit after the installation.

6.4.1.1 Status

The **Status** tab delivers the status of RAID "volume", which means one or more disk drives working together as a logical drive. Video recording requires a RAID volume to be created first.

To access the **Status** tab:

On the **Live View** screen, click menu list button  > **Main Menu** button 
> **Storage** button  > **RAID Management** button > **Status** tab.

The **Status** tab opens and shows the created RAID volume(s) in the system.

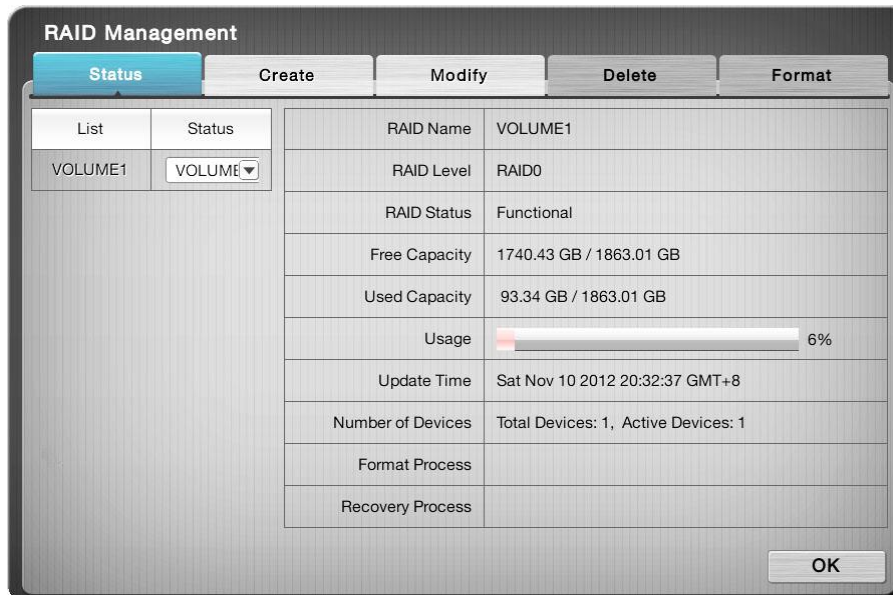

On the **Status** tab, the featured settings are:

Setting	Description	Default
List	Delivers the present RAID volume(s) in the system.	--
Status	Switches the status info between the present RAID volume(s) and disk(s). <ul style="list-style-type: none"> If there hasn't been any RAID volume created yet, "No Volume" is displayed here. 	If there is any created RAID volume already, "Volume 1" displays here by default; otherwise, "No Volume" displays here.

The status info delivered for a present RAID volume is:

Info	Description										
RAID Name	Delivers the name of the RAID volume, which is auto-assigned when the volume is created.										
RAID Level	Delivers the RAID level, which is defined when the volume is created. <ul style="list-style-type: none"> The selectable levels depend on the number of drives present in the system.. See Create to know how to define the RAID level. 										
RAID Status	Delivers the following statuses of the RAID volume: <table border="1"> <thead> <tr> <th>Message</th> <th>Description</th> </tr> </thead> <tbody> <tr> <td>Functional</td> <td>The RAID volume is normally operating.</td> </tr> <tr> <td>Critical</td> <td>There are some problems with the RAID volume, but video recording is normal.</td> </tr> <tr> <td>Offline</td> <td>The RAID volume cannot be found. Hence video recording is stopped and the storage cannot be accessed.</td> </tr> <tr> <td>File system error</td> <td>RAID volume is found but isn't mounted so video recording is stopped and storage cannot be accessed.</td> </tr> </tbody> </table>	Message	Description	Functional	The RAID volume is normally operating.	Critical	There are some problems with the RAID volume, but video recording is normal.	Offline	The RAID volume cannot be found. Hence video recording is stopped and the storage cannot be accessed.	File system error	RAID volume is found but isn't mounted so video recording is stopped and storage cannot be accessed.
Message	Description										
Functional	The RAID volume is normally operating.										
Critical	There are some problems with the RAID volume, but video recording is normal.										
Offline	The RAID volume cannot be found. Hence video recording is stopped and the storage cannot be accessed.										
File system error	RAID volume is found but isn't mounted so video recording is stopped and storage cannot be accessed.										
Free Capacity	Delivers the free space on the RAID volume.										
Used	Delivers the used space on the RAID volume.										

Capacity	
Usage	Delivers the percentage of the RAID volume's usage.
Update Time	Delivers the time when the RAID volume is created/updated.
Number of Devices	Delivers the total number of the disk(s) covered by the RAID volume and also the number of the disk(s) that is active, failed or spare.
Format Process	Delivers the formatting progress if the RAID volume is being formatted at the moment.
Recovery Process	Delivers the recovery progress if the RAID volume is being recovered at the moment.

The status info delivered for a present disk is:

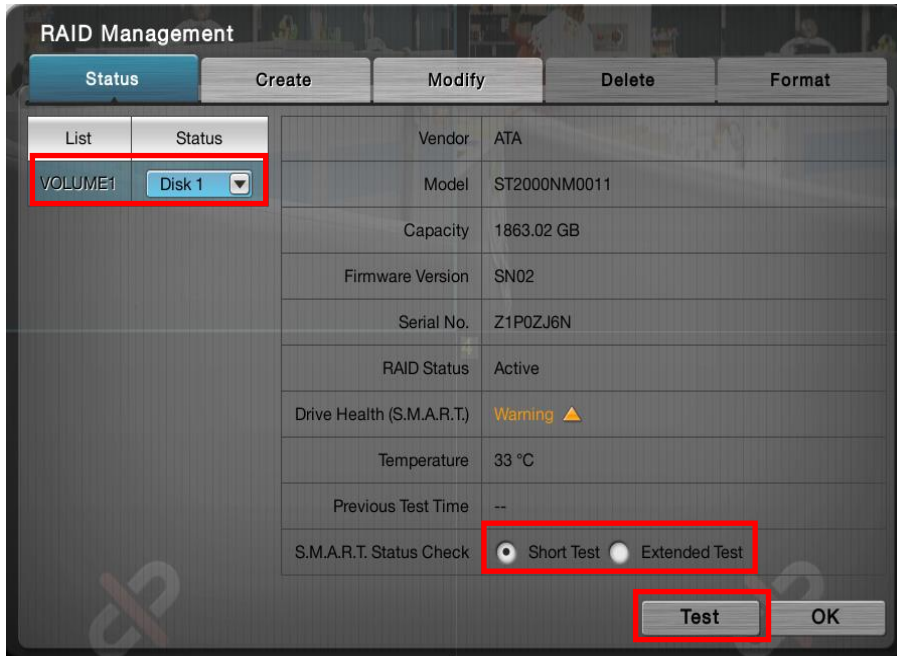

Click the **Test** button to run SMART test.



Click the **Stop Test** button to stop the test.



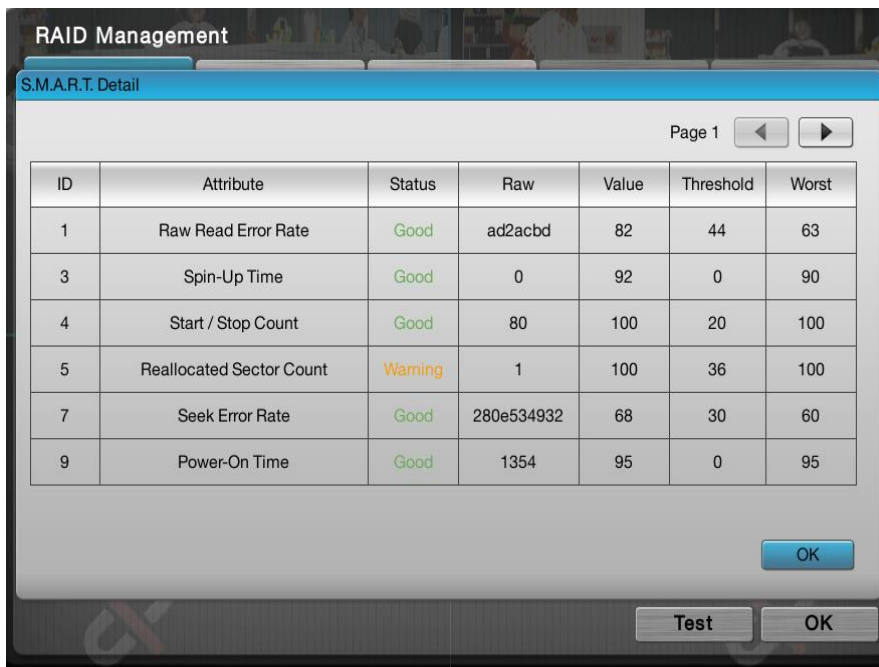

Click the **Drive Health (SMART) status** button to view the details of SMART result.



Click the **OK** button to quit the page.

Info	Description
Vendor	Delivers the manufacturer of the disk.
Model	Delivers the model number of the disk.
Capacity	Delivers the total capacity of the disk.



Firmware	Delivers the firmware version of the disk.
Serial No.	Delivers the serial number of the disk.
RAID Status	Delivers the status of the RAID that the disk belongs to.
Drive Health (SMART)	<p>Delivers the status of drive health by SMART self-test. The results will show as follows. Click on the icon to view the detail SMART test report.</p> <ul style="list-style-type: none"> ▶  Good: The disk is healthy and able to work normally. ▶  Warning: The disk is damaged. Recommend you to change the disk as soon as possible. ▶  Abnormal: The disk is damaged seriously and it may cause the system errors. Strongly recommend you to stop recording and change the disk immediately.
Temperature	Delivers the temperature of the disk.
Previous Test Time	Delivers the previous SMART self-test time.
SMART Status Check	<p>Run SMART test to update the Drive Health result. The test divides into 2 modes. Both of the test modes may affect the recording performance. You may need to stop recording to run the test.</p> <ul style="list-style-type: none"> ▶ Short Test: It would take 3-5 minutes for the short test. ▶ Extended Test: It would take more than 300 minutes for the extended test.

Click the **OK** button to quit the tab.

6.4.1.2 Create

The **Create** tab enables the creation of RAID volumes in the system.

To access the **Create** tab:

On the **Live View** screen, click menu list button  > **Main Menu** button 
 > **Storage** button  > **RAID Management** button > **Create** tab.

The **Create** tab opens and shows the disk(s) that hasn't been assigned to any RAID volume yet.





On the **Create** tab, the featured settings are:

Setting		Description	Default
RAID Level		Defines the RAID level.	It depends on the number of drives present in the system
Assigned Disk(s)	Disk #	Selects a disk to assign it to the RAID volume to be created.	Deselected

Click the **Create** button to create the configured RAID volume.

Click the **Exit** button to quit the tab.

 The RAID Volume will be functional on another unit if **all** disks of this volume are moved to the unit.

 After setting RAID level, you are not allowed to change neither the RAID level nor the number of disks containing in this volume.

 Separate embedded disk(s) and external disk (DAS) from two groups, which implies there is no way to create a single volume with both embedded and external disks inside.



In 8bay RAID model, the embedded disk(s) are separated to two groups. Each group management its own RAID volume.

6.4.1.3 Modify

This function is designed for replacing a broken hard drive with a new one, instead of modifying RAID level.

In the case of “Critical” RAID status, a warning message will notice that one of the RAID volume’s disks may be damaged. Although the video recording won’t be impacted, an immediate replacement is recommended to protect the RAID volume from data loss.

To access the **Modify** tab:

On the **Live View** screen, click menu list button  > **Main Menu** button 
> **Storage** button  > **RAID Management** button > **Modify** tab.

The **Modify** tab opens



Modify a RAID volume:

- (1) Select the damaged disk to remove.
- (2) Click **Remove** button to remove the selected disk.
- (3) After the system remove the disk successfully, replace it with a new disk, and back to the **Modify** tab to add this new free disk.



This function isn't applicable to RAID 0, which has no data protection mechanism by



nature.

This function is recommended for any unexpected disk damage. Use this function to safely unplug the running HDD.

6.4.1.4 Delete

The **Delete** tab enables the deletion of RAID volumes.

To access the **Delete** tab:

On the **Live View** screen, click menu list button  > **Main Menu** button 
> **Storage** button  > **RAID Management** button > **Delete** tab.

The **Delete** tab opens and shows the created RAID volume(s) in the system.

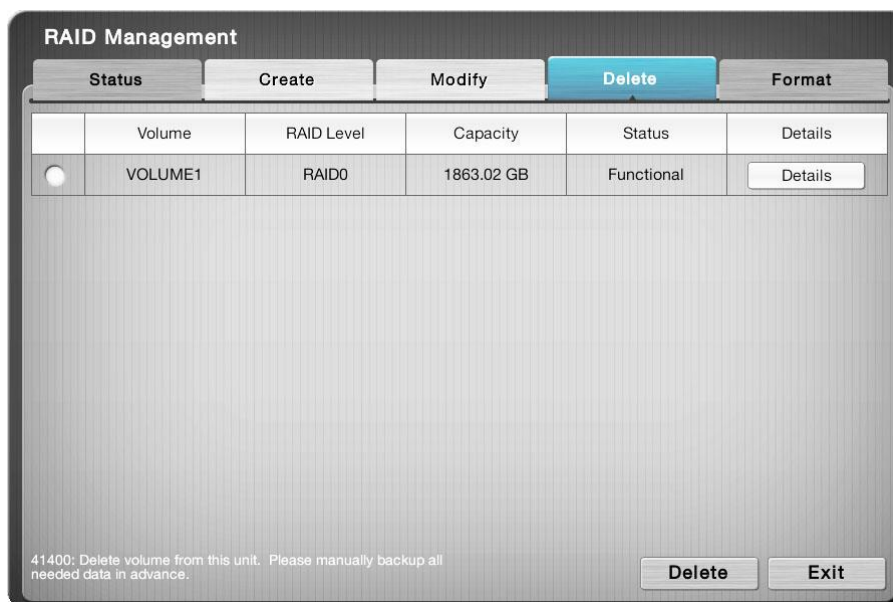

On the **Delete** tab, the featured settings are:

Setting	Description	Default
Details button	Views the details of the RAID volume's disk(s) including disk identity, model number and total capacity.	--
Delete button	Deletes the selected RAID volume.	--

Delete a RAID volume:

- (1) Select a RAID volume.
- (2) Click **Delete** button.



The selected RAID volume is deleted.

Click the **Exit** button to quit the setting.

6.4.1.5 Format

The **Format** tab enables formatting the RAID volumes functioning in the system.

To access the **Format** tab:

On the **Live View** screen, click menu list button  > **Main Menu** button 
> **Storage** button  > **RAID Management** button > **Format** tab.

The **Format** tab opens and shows the created RAID volume(s) in the system.



On the **Format** tab, the featured setting is:

Setting	Description	Default
Details button	Views the details of the RAID volume's disk(s) including disk identity, model number and total capacity.	--
Format button	Formats the selected RAID volume.	--

Format a RAID volume:

- (1) Select a RAID volume.
- (2) Click **Format** button,
The formatting starts and progresses.

Click the **Exit** button to quit the setting.

6.4.2 Auto Backup

Use the submenu **Auto Backup** to auto back up the videos recorded on the previous day to a FTP server. The **Auto Backup** requires two major settings, one is the backup schedule and the other is FTP server setting, which will be explicated in the following of this section.

To access the **Auto Backup** submenu:

Open **Storage** menu as described in [Storage](#).

The **Storage** menu opens.

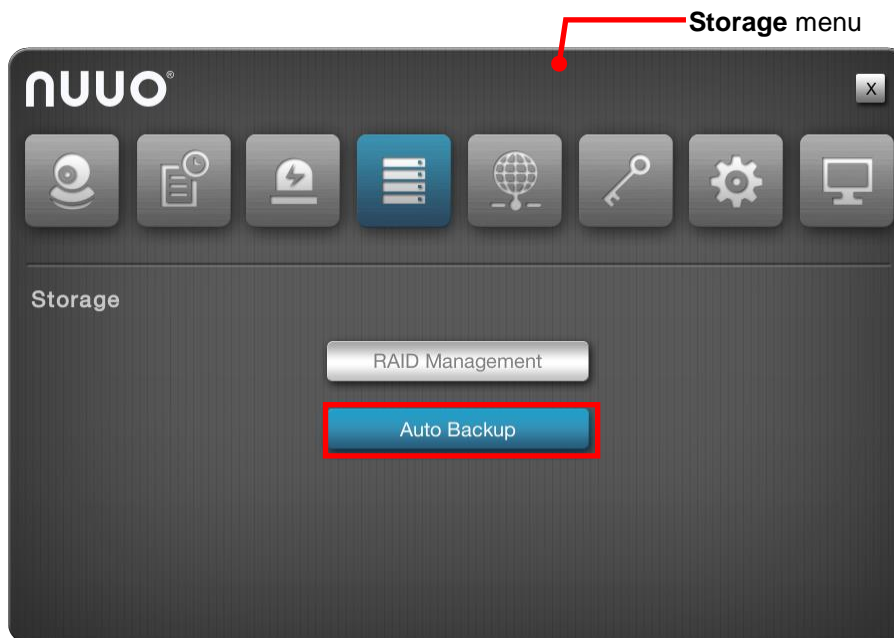

Click **Auto Backup** button.

The **Auto Backup** submenu opens and shows the **Schedule** tab.





For the follow-ups, see [Schedule](#) to configure backup schedule, or see [Server](#) to configure where to save the backup data.

6.4.2.1 Schedule

The **Schedule** tab enables/disables auto backing up the recorded videos to a FTP server. It also sets the daily time for the such backup.

To access the **Schedule** tab:

On the **Live View** screen, click menu list button  > **Main Menu** button 
 > **Storage** button  > **Auto Backup** button > **Schedule** tab.

The **Schedule** tab will open.



On the **Schedule** tab, the featured settings are:

Setting	Description	Default
Auto Backup	Enables/disables auto backing up the videos recorded on the previous day.	Deselected (Disabled)
Daily Backup Time	Sets the daily time for the system to do the auto backup.	00:00
Video Start Time	Sets the start time of recorded video of the previous day.	00:00
Video End Time	Sets the end time of recorded video of the previous day.	00:00
Video Channels	Sets the channel(s) to back up	All channels are deselected.

Click the **Save** button to apply the change(s).

Click the **Exit** button to quit the tab.

6.5 Network

Use the menu **Network** to configure the systems' networking so the system can connect and communicate with associated devices within the same subnet.

To access the **Network** menu:

Open the **Main Menu** as described in [Settings](#)

The **Main Menu** opens.

Click **Network** button .

The **Network** menu opens.

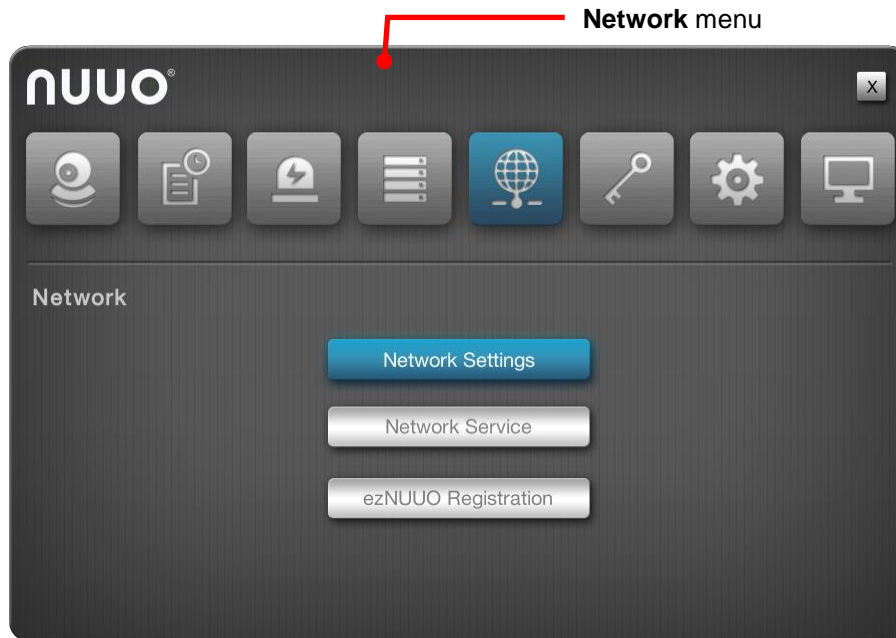

The **Network** menu features three submenus, **Network Settings**, **Network Service** and **ezNUUO Registration**, which are explicated in the following of this section.

6.5.1 Network Settings

As the name suggest, the **Network Settings** submenu sets the system's networking including IP address, subnet mask, default gateway and primary/secondary DNS.

To access the **Network Settings**:

Open **Network** menu as described in [Network](#).

The **Network** menu opens.



Click **Network Settings**.

The **Network Settings** submenu opens and shows the **Information** tab.

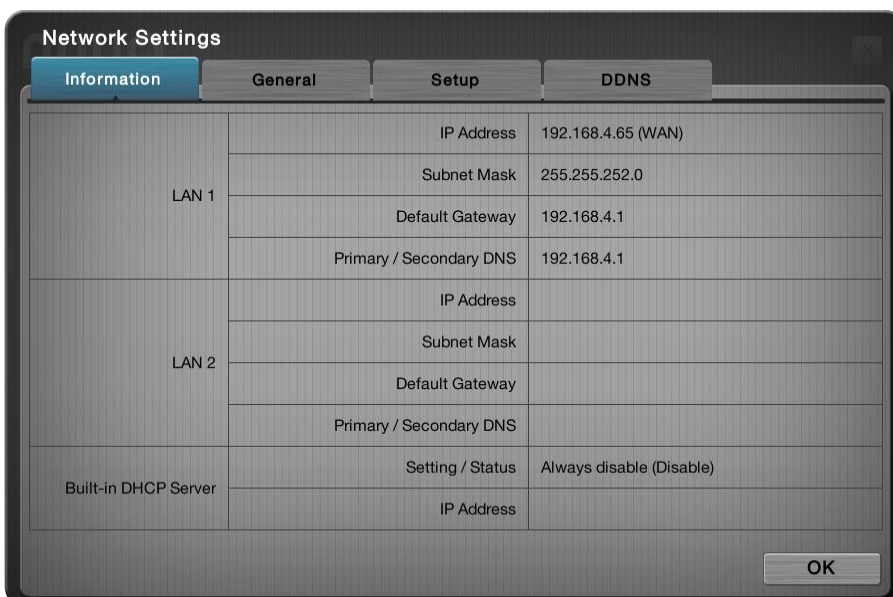



Network Settings features four tabs: **Information**, **General**, **Setup** and **DDNS**, which are detailed in the following of this section.

6.5.1.1 Information

The **Information** tab allows users to view the system’s Ethernet networking settings.

To access the **Information** tab:

On the **Live View** screen, click menu list button  > **Main Menu** button  > **Network** button  > **Network Settings** button > **Information** tab.

The **Information** tab opens and shows the network settings of the system’s LAN ports.

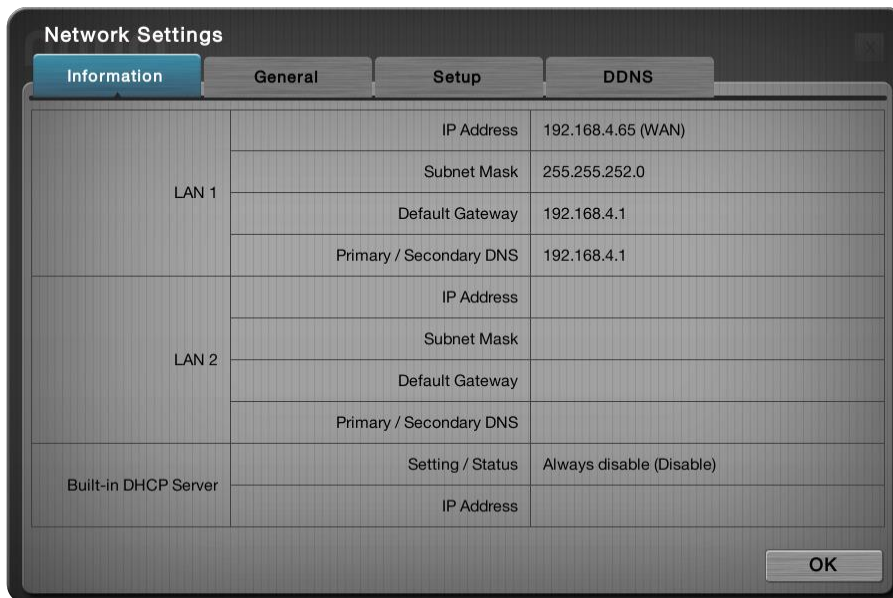

On the **Information** tab, the info delivered is:

Item	Description						
LAN 1 / LAN 2	Delivers the current network status of the two LAN ports. <ul style="list-style-type: none"> ▶ If a LAN port isn't in use, the network status isn't available. ▶ If a LAN port is in use, the following info is available: 						
	<table border="1"> <thead> <tr> <th>Info</th> <th>Description</th> </tr> </thead> <tbody> <tr> <td>IP Address</td> <td>Delivers the IP address assigned to this LAN port.</td> </tr> <tr> <td>Subnet Mask</td> <td>Delivers the subnet mask assigned to the IP address used on the LAN port.</td> </tr> </tbody> </table>	Info	Description	IP Address	Delivers the IP address assigned to this LAN port.	Subnet Mask	Delivers the subnet mask assigned to the IP address used on the LAN port.
	Info	Description					
IP Address	Delivers the IP address assigned to this LAN port.						
Subnet Mask	Delivers the subnet mask assigned to the IP address used on the LAN port.						

	<table border="1"> <tr> <td>Default Gateway</td> <td>Delivers the IP address assigned to the LAN port as gateway.</td> </tr> <tr> <td>Primary/Secondary DNS</td> <td>Delivers the IP address assigned to the LAN port as primary or secondary DNS (Domain Name System).</td> </tr> </table> <p>▶ To access the settings, see Setup.</p>	Default Gateway	Delivers the IP address assigned to the LAN port as gateway.	Primary/Secondary DNS	Delivers the IP address assigned to the LAN port as primary or secondary DNS (Domain Name System).		
Default Gateway	Delivers the IP address assigned to the LAN port as gateway.						
Primary/Secondary DNS	Delivers the IP address assigned to the LAN port as primary or secondary DNS (Domain Name System).						
Built-in DHCP Server	<p>Delivers the system's current "Built-in DHCP Server" status.</p> <p>▶ By the "Built-in DHCP Server", the system itself can act as a DHCP server to dynamically assign IP to its networked camera clients.</p> <p>▶ If the "Built-in DHCP Server" is enabled, the following info are available:</p> <table border="1"> <thead> <tr> <th>Info</th> <th>Description</th> </tr> </thead> <tbody> <tr> <td>Setting/Status</td> <td>Delivers the status of the "Built-in DHCP Server".</td> </tr> <tr> <td>IP Address</td> <td>Delivers the IP address assigned to the "Built-in DHCP Server"</td> </tr> </tbody> </table> <p>▶ To access the settings, see Setup</p>	Info	Description	Setting/Status	Delivers the status of the "Built-in DHCP Server".	IP Address	Delivers the IP address assigned to the "Built-in DHCP Server"
Info	Description						
Setting/Status	Delivers the status of the "Built-in DHCP Server".						
IP Address	Delivers the IP address assigned to the "Built-in DHCP Server"						



Click the **OK** button to quit the tab.

	<p>If all cameras are disconnected, please check if the network settings are</p> <ul style="list-style-type: none"> - LAN 1: static IP 192.168.1.100 (default) / not connected - LAN 2: DHCP / connected to switch, which subnet is 192.168.1.X or static IP 192.168.1.X / connected to switch, which subnet is 192.168.1.X <p>The reason of disconnection is that system transmits package via LAN 1 in such condition. The solution is changing the LAN 1 settings to DHCP or connecting network cable on LAN 1.</p>
--	--

6.5.1.2 General

The **General** tab configures the server name and selects which LAN is connected to the Internet.

To access the **General** tab:

On the **Live View** screen, click menu list button  > **Main Menu** button  > **Network** button  > **Network Settings** button > **General** tab.

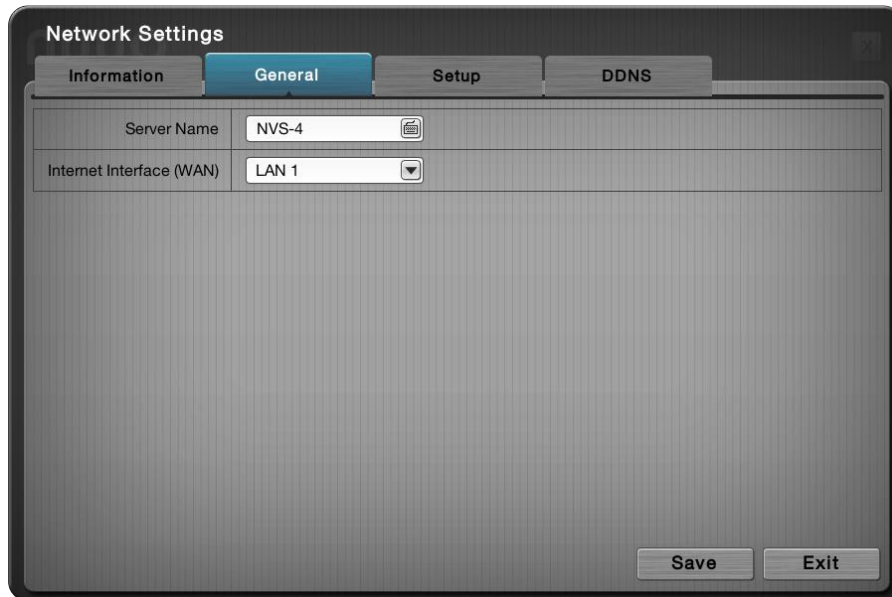

The featured settings on the **General** tab are:

Setting	Description	Default
Server Name	Gives the name of this unit for notifying users what unit is when receiving Email, push notification, etc.	NVS-X
Internet Interface (WAN)	Chooses which LAN is connected to the internet, which implies that there is no longer to fix the Internet access to LAN 1 for sending mails, activating license online, receiving auto upgrade notification, etc.	LAN 1

Click the **Save** button to apply the change(s).

Click the **Exit** button to quit the tab.

6.5.1.3 Setup

The **Setup** tab configures the networking for the system.

To access the **Setup** tab:



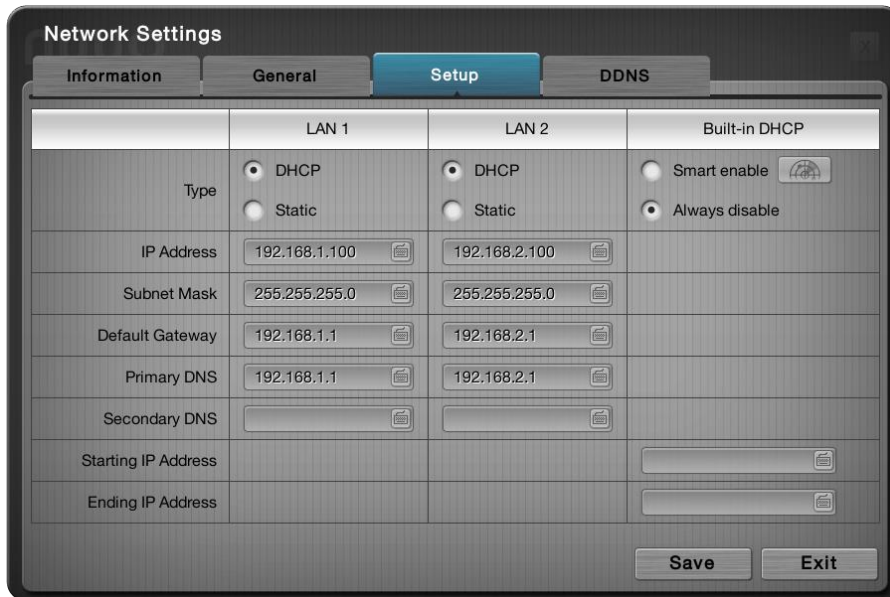

On the **Live View** screen, click menu list button  > **Main Menu** button 

> **Network** button  > **Network Settings** button > **Setup** tab.

The **Setup** tab opens and shows the system's current LAN ports in use and the settings thereof.



The featured settings on the **Setup** tab are:

Setting		Description	Default
LAN 1/2	Type	Assigns DHCP or static IP to the LAN port. ▶ Options available are DHCP or Static .	DHCP (if skipped with the Install Wizard)
Built-in DHCP	Type	Enables/disables "Built-in DHCP", which enables the system to dynamically assign IP addresses to the connected camera clients within the same subnet. ▶ Options available are Smart enable and Always disable . ▶ When set to Smart enable , the system's default static IP will be auto shown on setting page if no static IP has been set up before).	Always disable (if skipped with the Install Wizard)
IP Address		Assigns an IP address for the LAN port. ▶ This setting is only available when Type is set to Static . ▶ Click the keyboard icon  at the right of the field to open the virtual keyboard for text input.	192.168.1.100
Subnet Mask		Assigns the subnet mask for the IP address of the LAN port. ▶ This setting is only available when Type is set to Static . ▶ Click the keyboard icon  at the right of the field to open the virtual keyboard for text input.	255.255.255.0
Default Gateway		Assigns the IP address for the gateway for the LAN port. ▶ This setting is only available when Type is set to Static . ▶ Click the keyboard icon  at the right of the field to open the virtual keyboard for text input.	192.168.1.1
Primary DNS		Assigns the IP address for the primary DNS (Domain Naming System). ▶ This setting is only available when Type is set to Static . ▶ Click the keyboard icon  at the right of the field to open the virtual keyboard for text input.	192.168.1.1
Secondary		Assigns the IP address for the secondary DNS (Domain	--

DNS	Naming System). <ul style="list-style-type: none"> ▶ This setting is only available when Type is set to Static. ▶ Click the keyboard icon  at the right of the field to open the virtual keyboard for text input. 	
Starting IP Address	Sets the IP address for the built-in DHCP to start assigning from.	192.168.1.20
Ending IP Address	Sets the end of the IP address that the built-in DHCP assigns.	192.168.1.50

 There are two Giga LANs per unit. We recommend that you use them under the scenario of two subnets, one for the cameras/devices, and the other for the remote access. If you deploy two LANs within the same subnet, it's likely to cause parts of the cameras disconnected as either one of the LAN is disconnected.

Click the **Save** button to apply the change(s).

Click the **Exit** button to quit the tab.

6.5.1.4 DDNS

The **DDNS** tab enables/disables DDNS, which allows the system to use dynamic IP address. This page also sets the DDNS profile.

To access the **DDNS** tab:



On the **Live View** screen, click menu list button  > **Main Menu** button 

> **Network** button  > **Network Settings** button > **DDNS** tab.

The **DDNS** tab will open.



The featured settings on the **DDNS** tab are:

Setting	Description	Default
DDNS	Enables/disables DDNS for the system	Deselected (Disabled)
Provider	Sets the provider of the DDNS service. ▶ Options available are DynDns and DtDNS .	DynDns
Username	Sets the username to login to the DDNS service. ▶ Click the keyboard icon  at the right of the field to open the virtual keyboard for text input.	--
Password	Sets the password to login to the DDNS service. ▶ Click the keyboard icon  at the right of the field to open the virtual keyboard for text input.	--
Host Name	Enters the sub domain name. ▶ Click the keyboard icon  at the right of the field to open the virtual keyboard for text input.	--
Update Cycle	Since the IP is dynamic, sets how often to refresh the DNS to point to the server's changing IP address.	16 minutes

Click the **Save** button to apply the change(s).

Click the **Exit** button to quit the tab.

6.5.2 Network Service

The **Network Service** submenu controls the remote accesses to the system for liveview streaming, playback, CMS and management.

To access the **Network Service** submenu:

Open **Network** menu as described in [Network](#).

The **Network** menu opens.

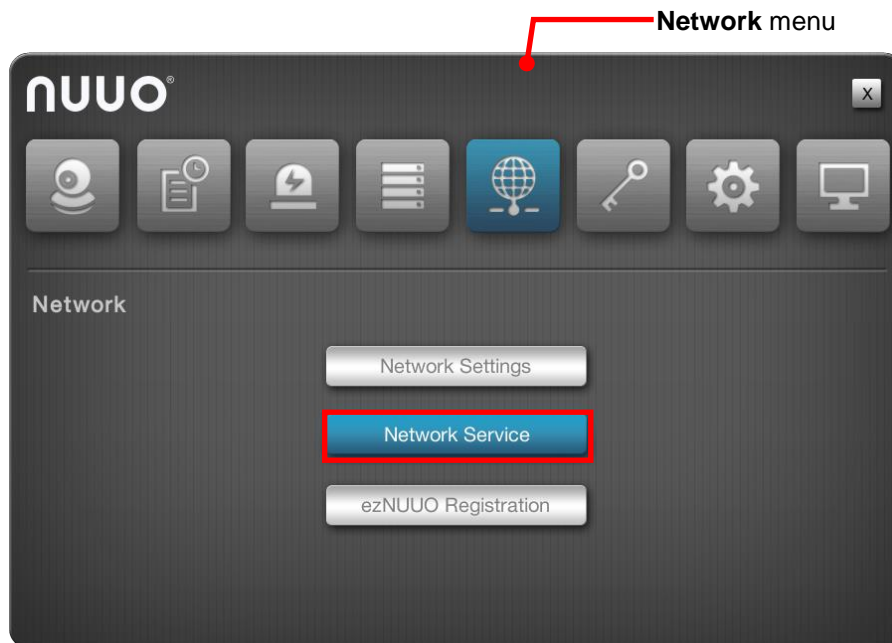

Click **Network Service** button.



The **Network Service** submenu opens and shows the **Service** tab.



Network Settings submenu features one tabs: **Service**, which is detailed in the following of this section.

6.5.2.1 Service



To access the **Service** tab:



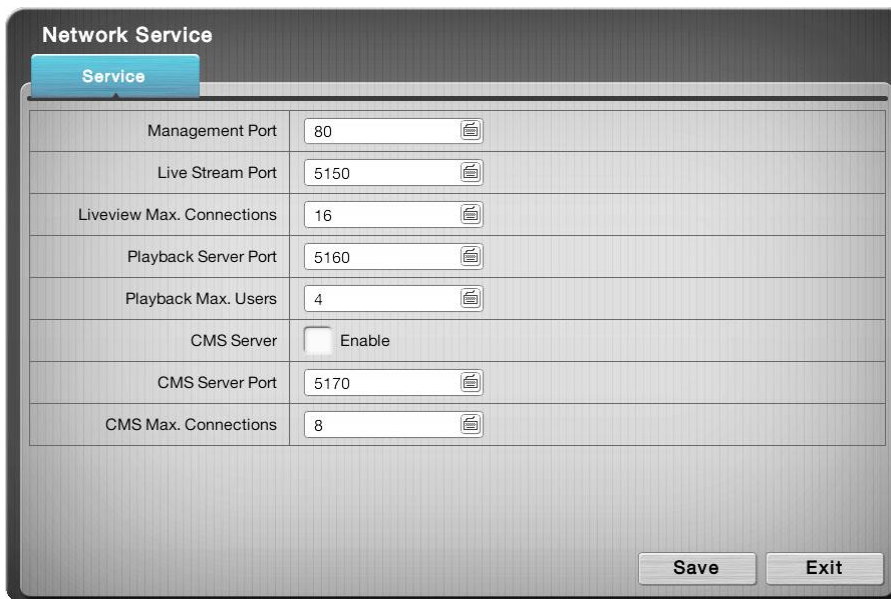

On the **Live View** screen, click menu list button  > **Main Menu** button 
 > **Network** button  > **Network Service** button > **Service** tab.

The **Service** tab will open.



The **Service** tab features the following settings:

Item	Description	Default
Management Port	Sets the transmission port for remote settings	80
Live Stream Port	Sets the transmission port for liveview streaming. ▶ Click the keyboard icon  at the right of the field to open the virtual keyboard for text input.	5150
Liveview Connection Max.	Sets the maximum number of remote connections allowed. ▶ 1 to 64 configurable. ▶ "One connection" means one user connects to one camera. If one user connects to two cameras, the number of connections is 2. ▶ Click the keyboard icon  at the right of the field to open the virtual keyboard for text input.	16

Playback Server Port	<p>Sets the transmission port for playback service.</p> <ul style="list-style-type: none"> ▶ Click the keyboard icon  at the right of the field to open the virtual keyboard for text input. 	5160
Playback Max. Users	<p>Sets the maximum number of users allowed to simultaneously access the server for playback.</p> <ul style="list-style-type: none"> ▶ 1 to 8 configurable. ▶ "One user" means one user who is accessing. ▶ Click the keyboard icon  at the right of the field to open the virtual keyboard for text input. 	4
CMS Server	Enables/disables CMS service.	Deselected (Disabled)
CMS Server Port	<p>Assigns the port number for CMS access.</p> <ul style="list-style-type: none"> ▶ Click the keyboard icon  at the right of the field to open the virtual keyboard for text input. 	5170
CMS Max. Connections	<p>Sets the maximum number of CMS connections allowed.</p> <ul style="list-style-type: none"> ▶ 1 to 8 configurable. ▶ "One connection" means one server can be connected by one CMS server. ▶ Click the keyboard icon  at the right of the field to open the virtual keyboard for text input. 	8

Click the **Save** button to apply the change(s).

Click the **Exit** button to quit the tab.

6.5.3 ezNUUO Registration

ezNUUO is designed to truly simplify the process of establishing Internet access to NUUO systems. It eliminates the need for setting up port forwarding and configuring firewall security. Simply register a server ID on the setting page, then go to ezNUUO website or sign in NUUO iViewer App to watch live videos and playback from wherever you are.

The **ezNUUO Registration** submenu helps users register a unique service ID. To use this feature in v1.0, the unit's LAN 1 must connect to the Internet.

To access the **ezNUUO Registration**:

Open **Network** menu as described in [Network](#).

The **Network** menu opens.

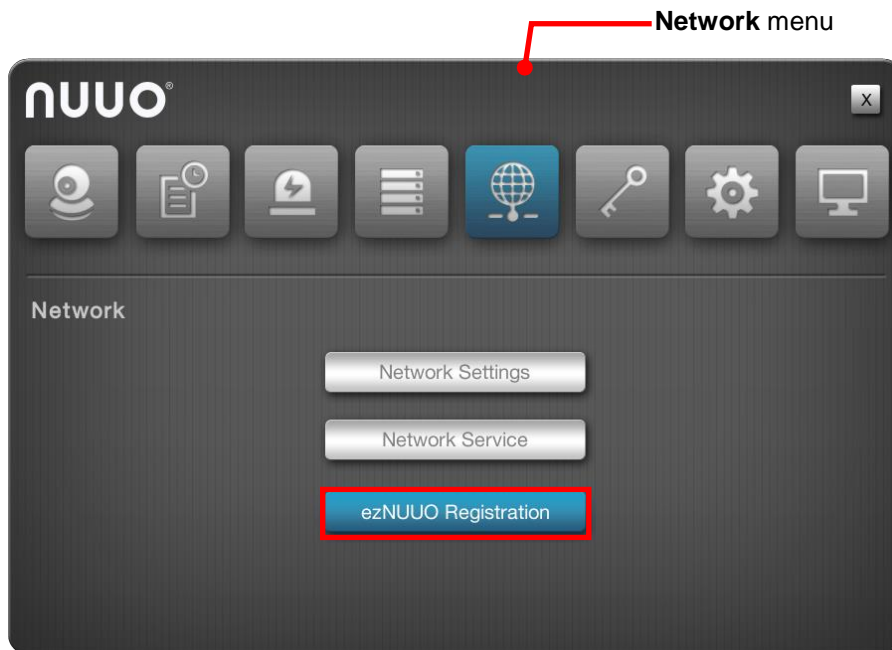

Click **ezNUUO Registration** button.

The **ezNUUO Registration** submenu opens and shows the **Registration** tab.





ezNUUO Registration submenu features one tabs: **Registration**, which is detailed in the following of this section.

6.5.3.1 Registration

As mentioned above, users can access the server system via web browser or mobile phone without router settings simply by a registration with ezNUUO. To register a server ID, it relies on the **Registration** tab.

To access the **Registration** tab:

On the **Live View** screen, click menu list button  > **Main Menu** button 
> **Network** button  > **ezNUUO Registration** button > **Registration** tab.

The **Registration** tab will open.



The **Registration** tab features the following settings:

Item	Description	Default
ezNUUO Service	Enables the P2P service.	Disabled
Server ID	Sets the server ID for this unit. <ul style="list-style-type: none"> ▶ Click the keyboard icon  at the right of the field to open the virtual keyboard for text input. 	--

Register an account with ezNUUO:

- 1) Open the **Registration** tab as mentioned above.
- 2) Enter a desired server ID in the **Server ID** field.
- 3) Click the keyboard icon  at the right of the field to open the virtual keyboard for text input.
- 4) Click the **Test** button to check the availability of the desired server ID.
- 5) Click **Save** button to submit.
- 6) Now you can login to www.eznuuo.com on a Windows web browser to configure, watch live videos and playback with any other settings, such as port forwarding or DDNS setup. All you need to know is the server ID, username and password. What's more, you can also sign in to mobile app **iSecurity** by scanning QR code to watch live videos and playback from everywhere you are.



Click the **Save** button to apply the change(s).
Click the **Exit** button to quit the tab.



To support to access to the NVR system via mobile app iViewer, you have to upgrade the iViewer to v3.0 or above.

6.6 Management

Use the menu **Management** to manage and control the access list to the system, activate camera license or POS license, save/load configuration and check logs. The menu also facilitates viewing users' permitted activities on the system.

To access the **Management** menu:

Open the **Main Menu** as described in [Settings](#)

The **Main Menu** opens.

Click **Management** button .

The **Management** menu opens.

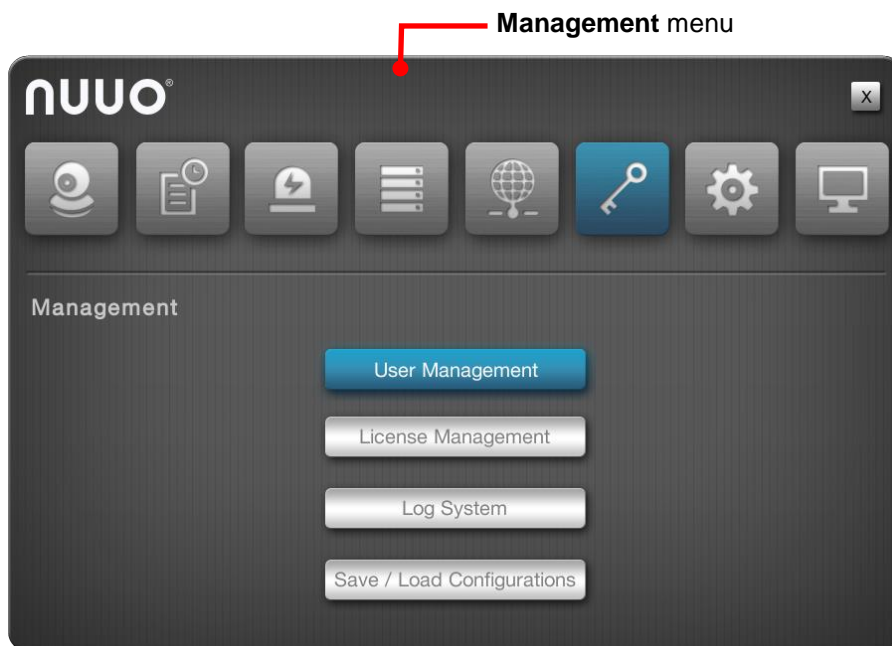

The **Management** menu features four submenus, **User Management**, **License Management**, **Log System** and **Save / Load Configuration**, which are explicated in the following of this section.

6.6.1 User Management

As the name suggest, the **User Management** submenu manages the user accounts and their privilege to access the system.

To access the **User Management** submenu:

Open **Management** menu as described in [Management](#).

The **Management** menu opens.

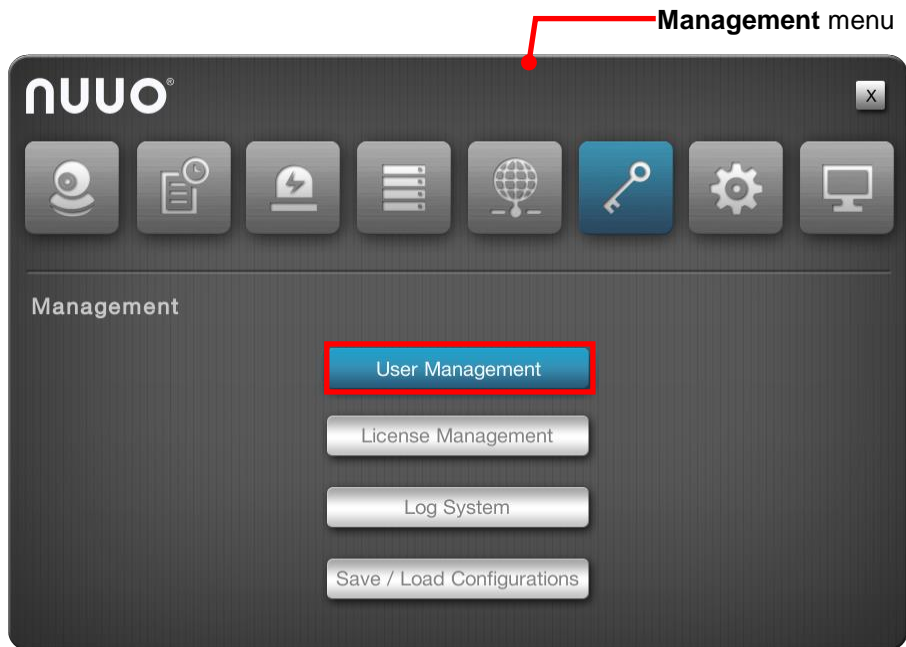

Click **User Management** button.

The **User Management** submenu opens and shows the **General** tab.

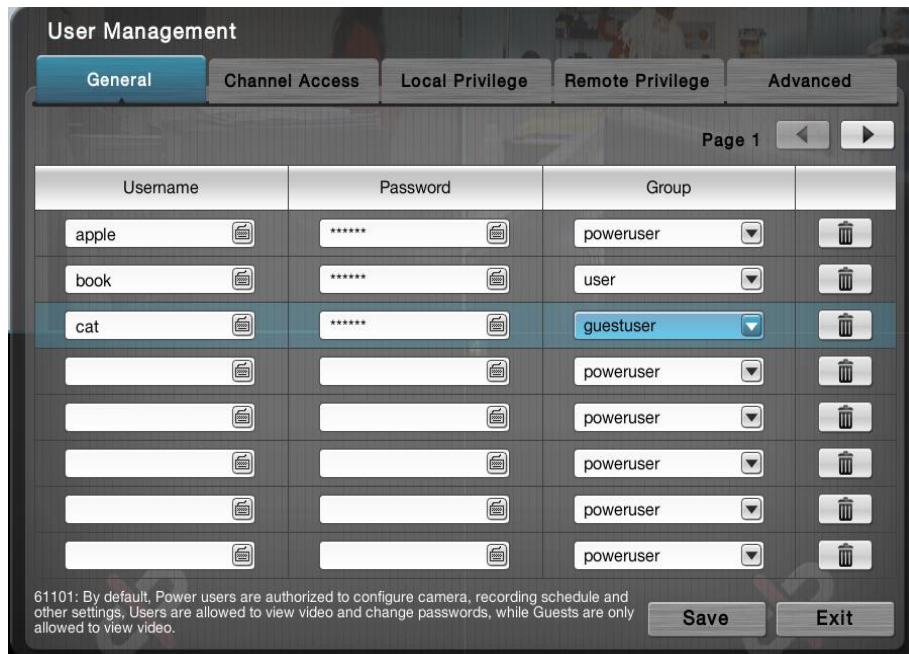

User Management features four tabs: **General**, **Channel Access**, **Local Privilege**, **Remote Privilege**, and **Advanced** which are detailed in the following of this section.

6.6.1.1 General

The **General** tab creates, edits and deletes user accounts.



To access the **General** tab:

On the **Live View** screen, click menu list button > **Main Menu** button > **Management** button > **User Management** button > **General** tab.

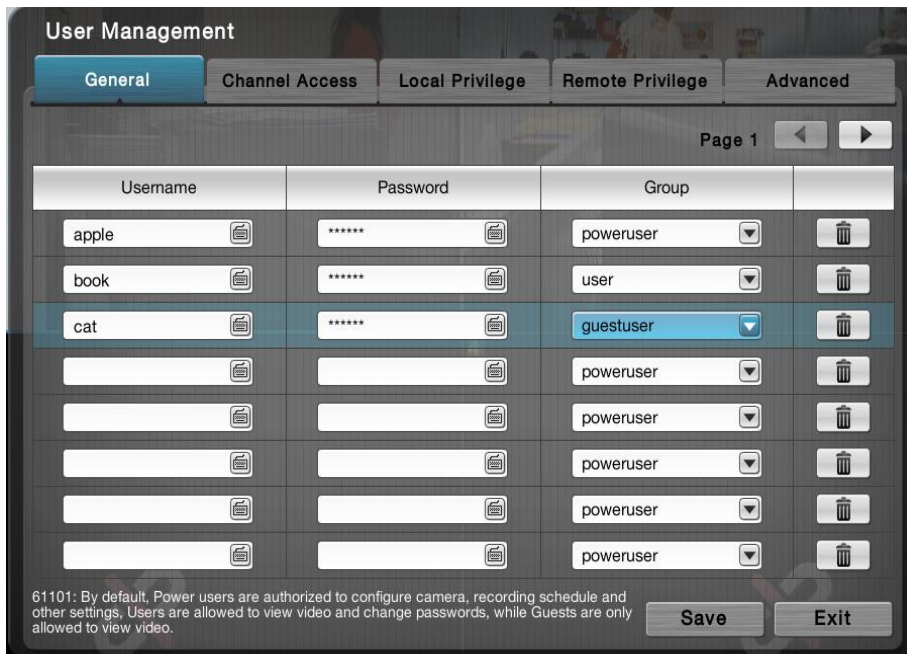
The **General** tab opens and shows the list of users admitted to the system.



The settings featured on the **General** tab are:

Setting	Description	Default								
Username	Sets the username for the user account. ▶ Click the keyboard icon  at the right of the field to open the virtual keyboard for text input.	--								
Password	Sets the password for the user account. ▶ Click the keyboard icon  at the right of the field to open the virtual keyboard for text input.	--								
Group	Assigns a user group for the user accounts. ▶ Options available are power user , user and guest user , which are summarized as follows: <table border="1" data-bbox="406 1227 1098 1545"> <thead> <tr> <th>Group</th> <th>Description</th> </tr> </thead> <tbody> <tr> <td>power user</td> <td>A "power user" is allowed to access all the system's settings except the Network Settings, RAID Settings and Management.</td> </tr> <tr> <td>user</td> <td>A "user" can only change his/her password and access liveview streaming and playback.</td> </tr> <tr> <td>guest user</td> <td>A "guest user" can only access the system for liveview and playback.</td> </tr> </tbody> </table>	Group	Description	power user	A "power user" is allowed to access all the system's settings except the Network Settings, RAID Settings and Management.	user	A "user" can only change his/her password and access liveview streaming and playback.	guest user	A "guest user" can only access the system for liveview and playback.	Power user
Group	Description									
power user	A "power user" is allowed to access all the system's settings except the Network Settings, RAID Settings and Management.									
user	A "user" can only change his/her password and access liveview streaming and playback.									
guest user	A "guest user" can only access the system for liveview and playback.									
Delete button 	Deletes the user.	--								

Click the **Save** button to apply the change(s).



Click the **Exit** button to quit the tab.

6.6.1.2 Channel Access

Open the **Channel Access** tab to run a list of user(s) that are permitted to

liveview stream and play videos.

To access the **General Access** tab:

On the **Live View** screen, click menu list button  > **Main Menu** button 
> **Management** button  > **User Management** button > **Channel Access** tab.

The **Channel Access** tab opens and shows a list of users accessing the liveview and playback on the system at the moment.

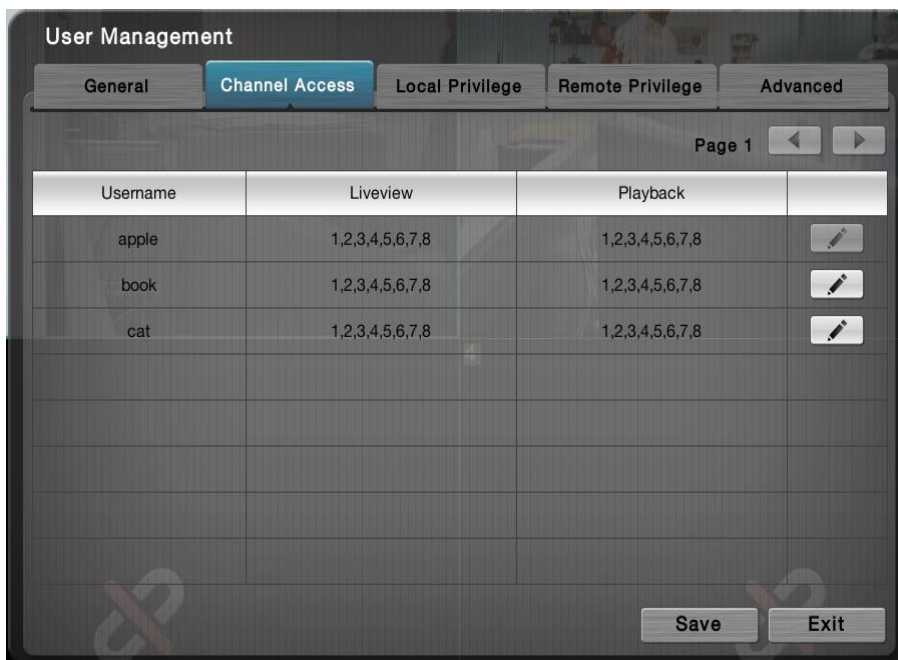

Click the  button to edit a user's access to a Liveview channel or Playback channel.





Click the **Save** button to apply the change(s).

Click the **Exit** button to quit the tab.

6.6.1.3 Local Privilege

Open the **Local Privilege** tab to run a list of user(s) that are permitted to locally access some system services.

To access the **Local Privilege** tab:

On the **Live View** screen, click menu list button  > **Main Menu** button 
> **Management** button  > **User Management** button > **Local Privilege** tab.

The **Local Privilege** tab opens and shows the list of users permitted to locally sign in, do PTZ and some system configurations differed from privileges of each group.

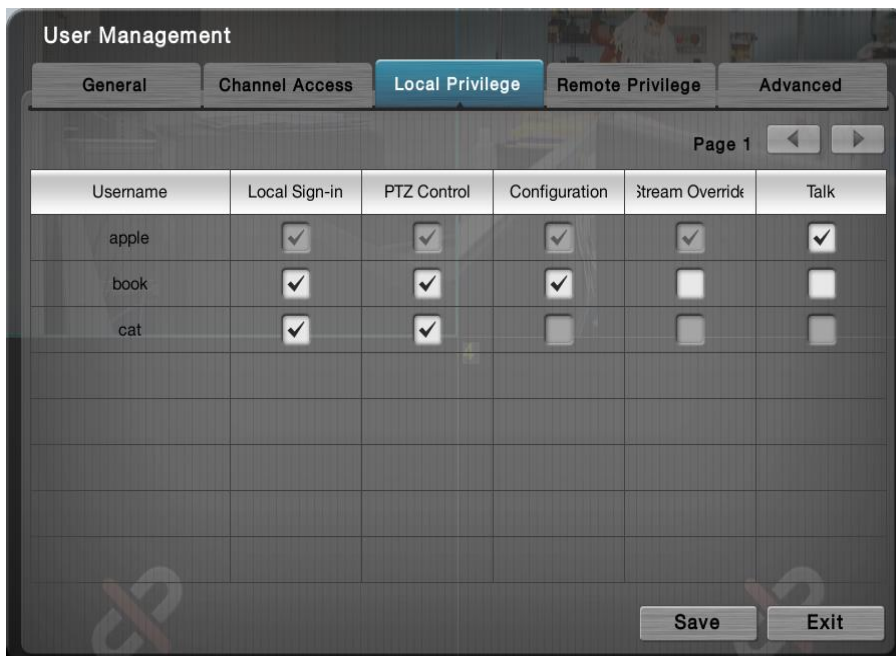

Select a service to enable the user for it, and deselect a service to disable the user from it.



Click the **Save** button to apply the change(s).

Click the **Exit** button to quit the tab.

6.6.1.4 Remote Privilege

Open the **Remote Privilege** tab to run a list of user(s) that are permitted to remotely access some system services.

To access the **Remote Privilege** tab:

On the **Live View** screen, click menu list button  > **Main Menu** button 
> **Management** button  > **User Management** button > **Remote Privilege** tab.

The **Remote Privilege** tab opens and shows the list of users permitted to remotely do PTZ, input/output, data backup or delete, and open E-Map on remote client.

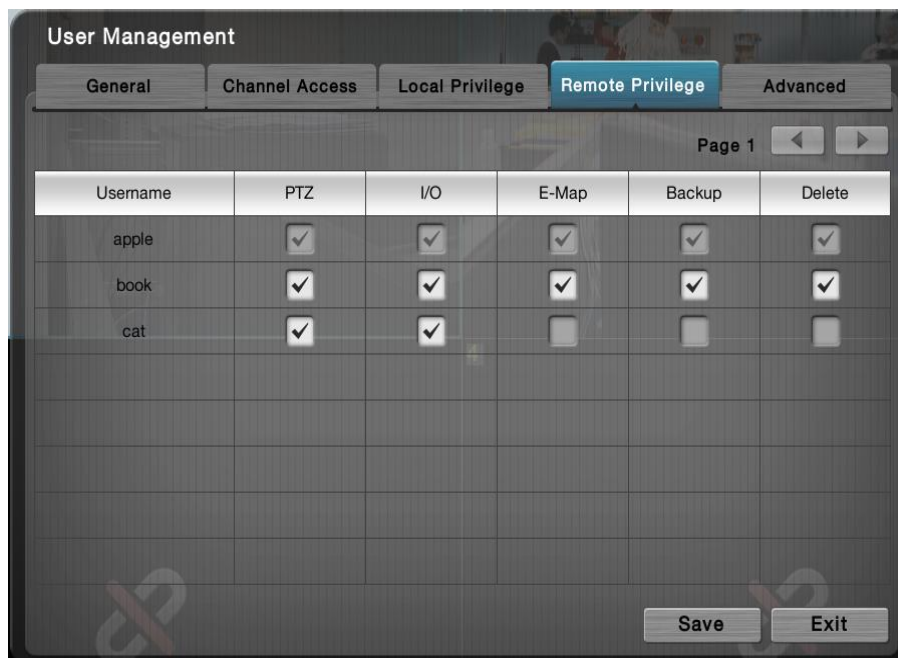

Select a service to enable the user for it, and deselect a service to disable the user from it.



Click the **Save** button to apply the change(s).

Click the **Exit** button to quit the tab.

6.7.1.5 Advanced

Open the **Advanced** tab to run a list of user(s) that are permitted to access some system services.

To access the **Advanced** tab:

On the **Live View** screen, click menu list button  > **Main Menu** button 
> **Management** button  > **User Management** button > **Advanced** tab.

The **Advanced** tab opens and shows the list of users permitted to browse log.

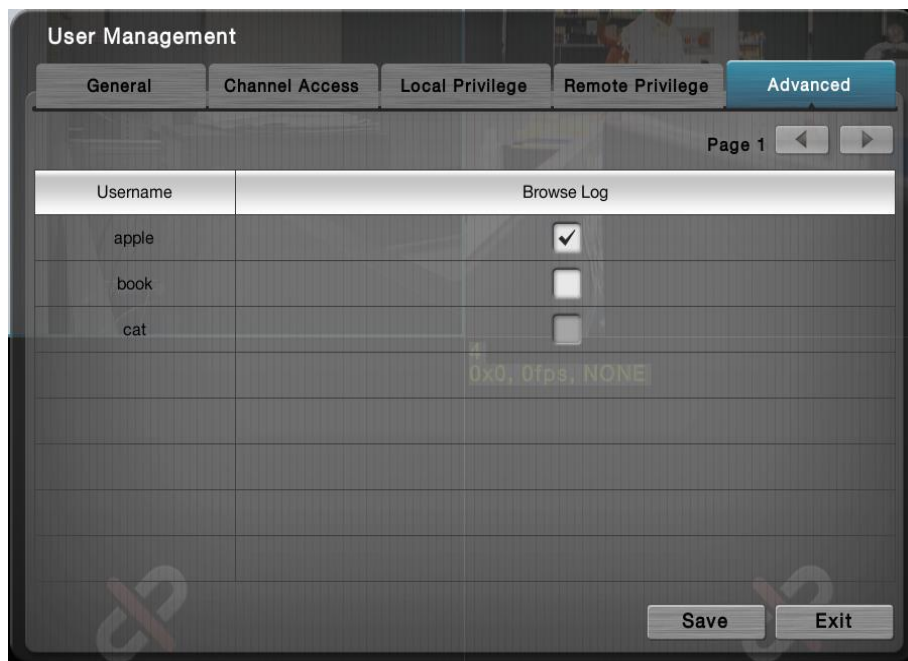

Select a service to enable the user for it, and deselect a service to disable the user from it.

Click the **Save** button to apply the change(s).

Click the **Exit** button to quit the tab.

6.6.2 License Management

Two types of licenses are available for users: one is the camera license; the other is POS license for all series. By camera license, the 4-channel system can have 8-channel capacity while 6-channel system can have up to 16-channel capacity for video recording and viewing. By the POS license upgrade, POS function becomes available.

The license activation relies on the operating system's **License Management** submenu. Follow through the guides hereunder to run an online or offline activation of the license key.

To access the **License Management** submenu:

Open **Management** menu as described in [Management](#).

The **Management** menu opens.

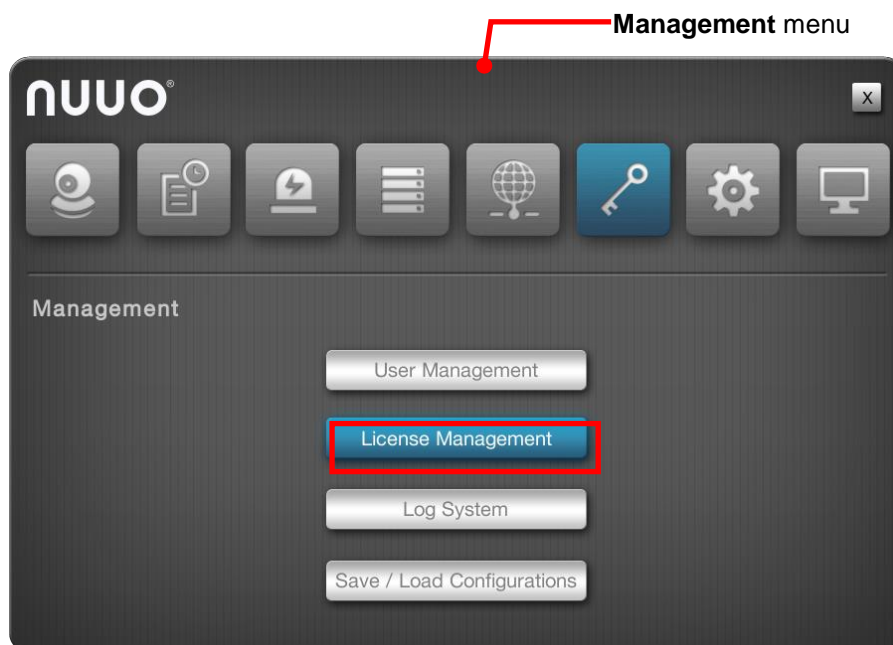

Click **License Management** button.

The **License Management** submenu opens and shows the **Online Activation** tab.

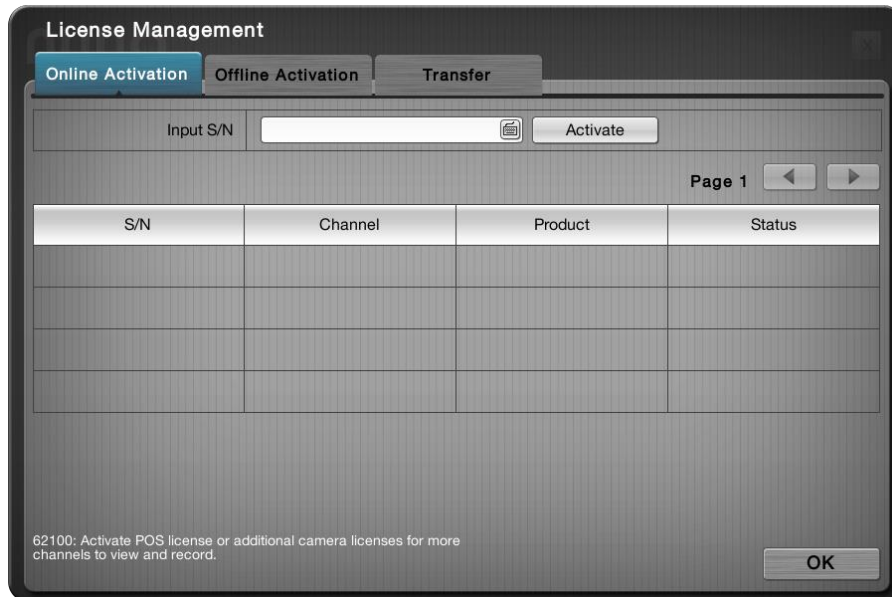



License Management submenu features three tabs: **Online Activation**, **Offline Activation** and **Transfer**, which are detailed in the following of this section.

6.6.2.1 Online Activation

If a license key (serial number) is available, activate it on the system by following through the steps below.

	In v1.0, the system has to connect to the Internet by LAN1 port to be able to run the online activation.
---	--

To access the **Online Activation** tab:

On the **Live View** screen, click menu list button  > **Main Menu** button 
 > **Management** button  > **License Management** button > **Online Activation** tab.

The **Online Activation** tab will open.

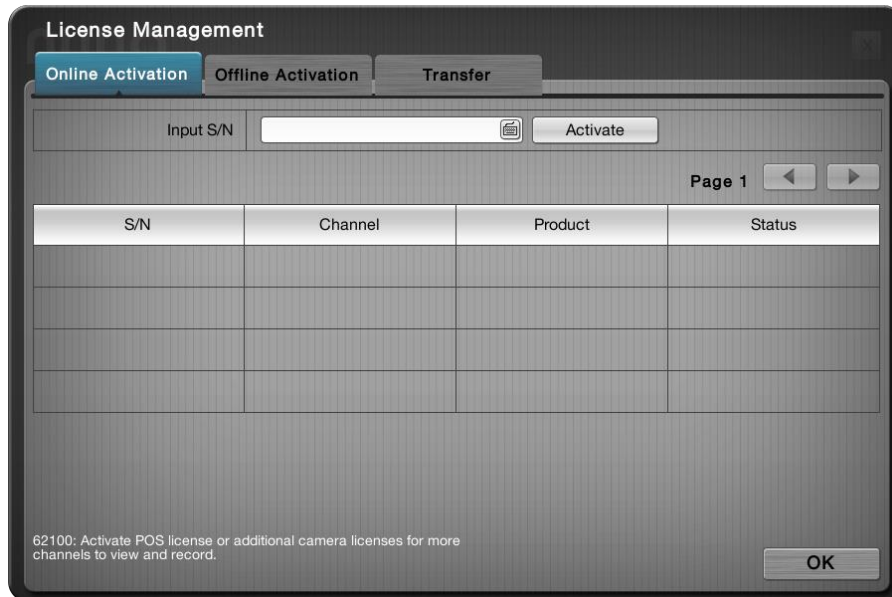

Upgrade the system with the available license key:

- (1) Open the **Online Activation** tab as described above.
- (2) Enter the serial number in the **Input S/N** field.
- (3) Click the keyboard icon  at the right of the field to open the virtual keyboard for text input.
- (4) Click **Activate** button.



Once the activation succeeds, the license will be updated with the license info displayed onscreen.

Click the **OK** button to quit the tab.

6.6.2.2 Offline Activation

If the system is offline in an Intranet (Local LAN) without Internet connection, use the **Offline Activation** to activate the license key.

To access the **Offline Activation** tab:

On the **Live View** screen, click menu list button  > **Main Menu** button 
 > **Management** button  > **License Management** button > **Offline Activation** tab.

The **Offline Activation** tab will open.

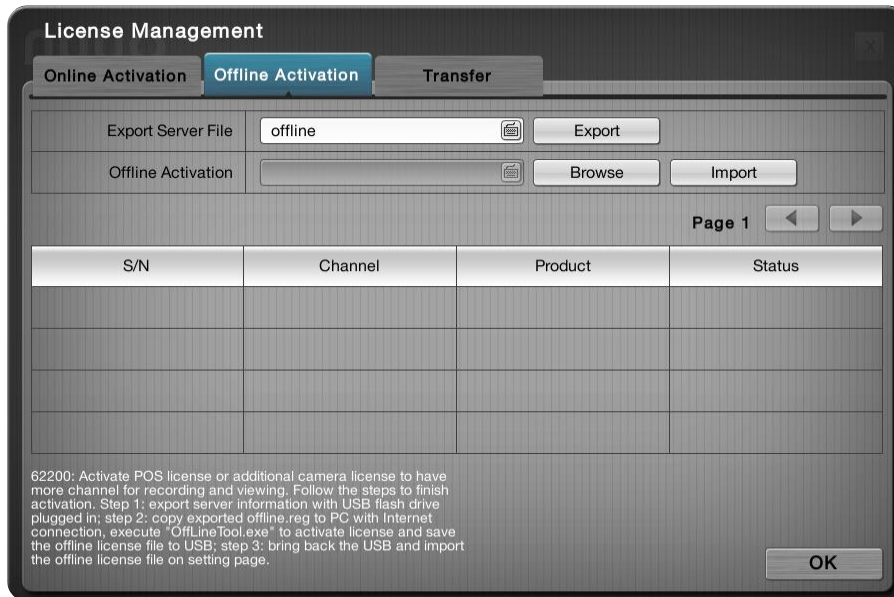

Upgrade the system with the available license key:

- (1) Have a USB flash drive. Plug it into any of the unit's USB ports.
- (2) Open the **Offline Activation** tab as described above
- (3) Click the **Export** button.

Then a dialog will pop up onscreen prompting the server file has been exported to the USB flash drive. Click **OK** button to close the dialog.

- (4) Copy the exported file named "offline.reg" to a PC that is online with Internet connection.
- (5) Run the executable file "OfflineTool.exe", which is included in NVRsolo toolkit.

The **Offline Tool** opens.

- (6) Select **Input SN file** and enter the license key in the field. Click the **Activate** button.
- (7) Save the offline license file "offline_license.dll" back to the USB flash drive.

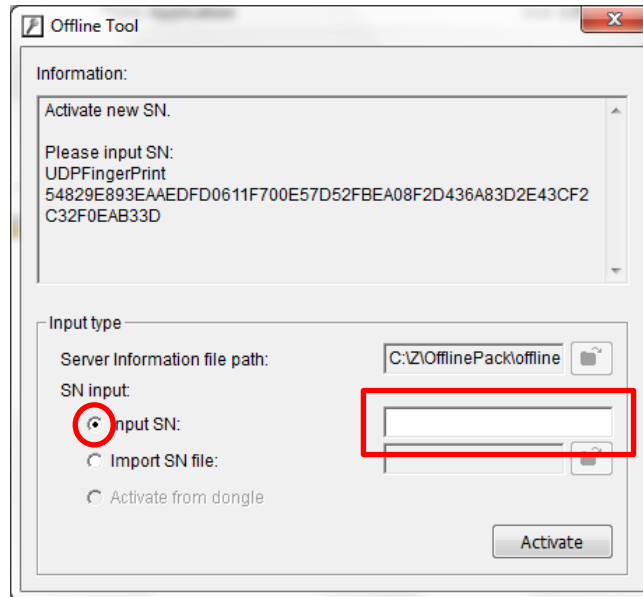



- (8) Plug the USB flash drive to one of the unit's USB ports.
- (9) Reopen the **Offline Activation** tab.
- (10) Click the **Browse** button to browse for the offline license file. Select the file.
- (11) Click the **Import** button to import the license file.
Once the activation succeeds, the license will be updated with the license info displayed onscreen.

Click the **OK** button to quit the tab.

6.6.2.3 Transfer

If the unit is going to be repaired or for any purposes you want to transfer the activated licenses, there are two ways to do, online and offline.

To access the **Transfer** tab:

On the **Live View** screen, click menu list button  > **Main Menu** button 
> **Management** button  > **License Management** button > **Transfer** tab.

The **Transfer** tab will open.

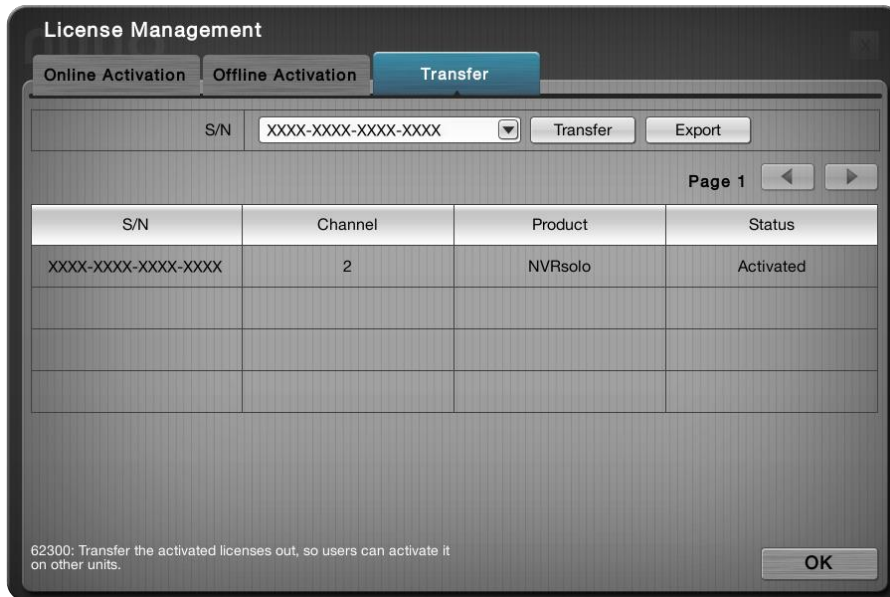

Transfer the activated license key online:

- (1) Select the license you want to transfer from the License List below, and click the **Transfer** button.
- (2) The license will be removed from License List if transferred successfully.

Click the **OK** button to quit the tab.

Transfer the activated license key offline:

- (1) Have a USB flash drive. Plug it into any of the unit's USB ports.
- (2) Select the license you want to transfer from the License List below, and click the **Export** button.

Then a dialog will pop up onscreen prompting the server file has been exported to the USB flash drive. Click **OK** button to close the dialog. The license will be removed from License List temporarily, but the transfer process is not finished yet.

- (3) Copy the exported file named "offline.reg" to a PC that is online with Internet connection.
- (4) Run the executable file "OfflineTool.exe", which is included in NVRsolo toolkit.

The **Offline Tool** opens.

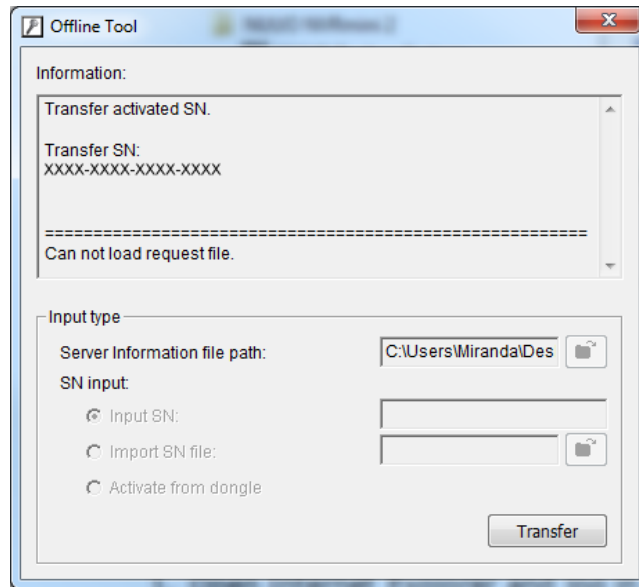

(5) The license you are going to transfer is listed. Click the **Transfer** button to finish the transfer process.

6.6.3 Log System

The **Log System** submenu allows users to view system events.

To access the **Log System** submenu:

Open **Management** menu as described in [Management](#).

The **Management** menu opens.

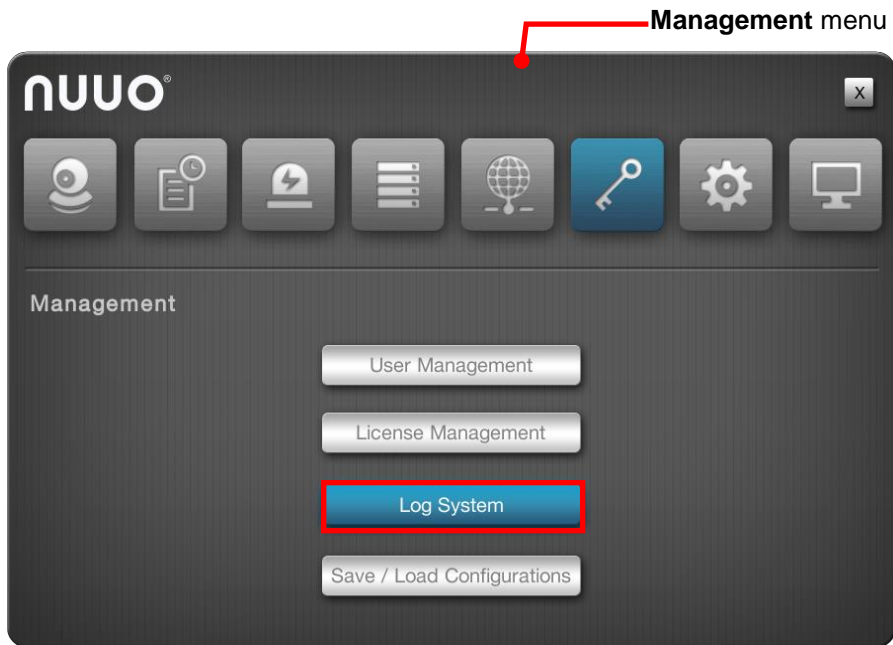

Click **Log System** button.

The **Log System** submenu opens and shows the **System Log** tab.

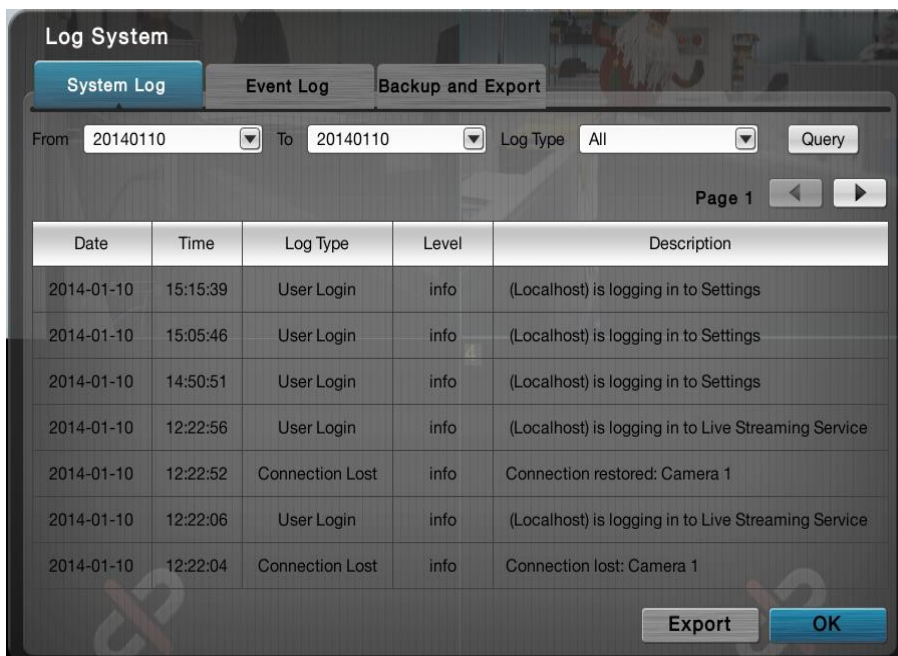



Log System submenu features four tabs: **System Log**, **Event Log**, and **Backup and Export**, which are detailed in the following of this section.

6.6.3.1 System Log

The **System Log** tab allows users to view the unit system operation history and activities such as power-on, shutdown, storage activity and so on.

To access the **System Log** tab:

On the **Live View** screen, click menu list button  > **Main Menu** button  > **Management** button  > **Log System** button > **System Log** tab.

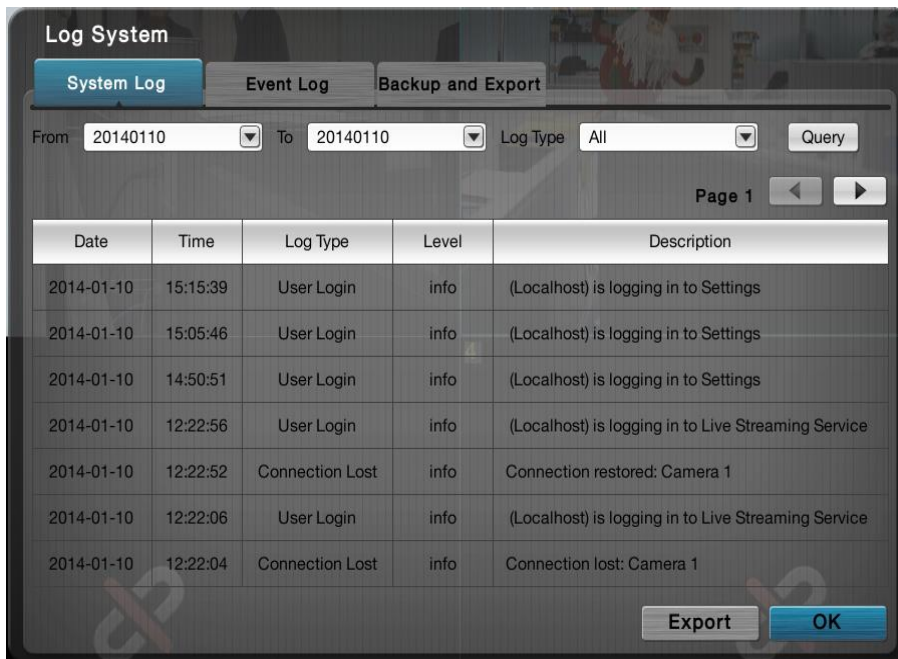

The **System Log** tab opens and shows the history.



Click the **OK** button to quit the tab.

The featured settings are:

Setting	Description	Default
	Switches the history to a specific range of time. To switch: 1. Click the down arrow of the date box	The current date



	and select a specific period of time. 2. Click the down arrow of the type box and select a type of log. 3. Click the Query button.	
Page 1  	Click the right arrow button to view more logs.	--

Click the **OK** button to quit the tab.

6.6.3.2 Event Log

The **Event Log** tab allows users to view the history of the events from the configured "Events & Actions", such as video motion detection or camera connection loss. See also [Event & Action](#).



To access the **Event Log** tab:



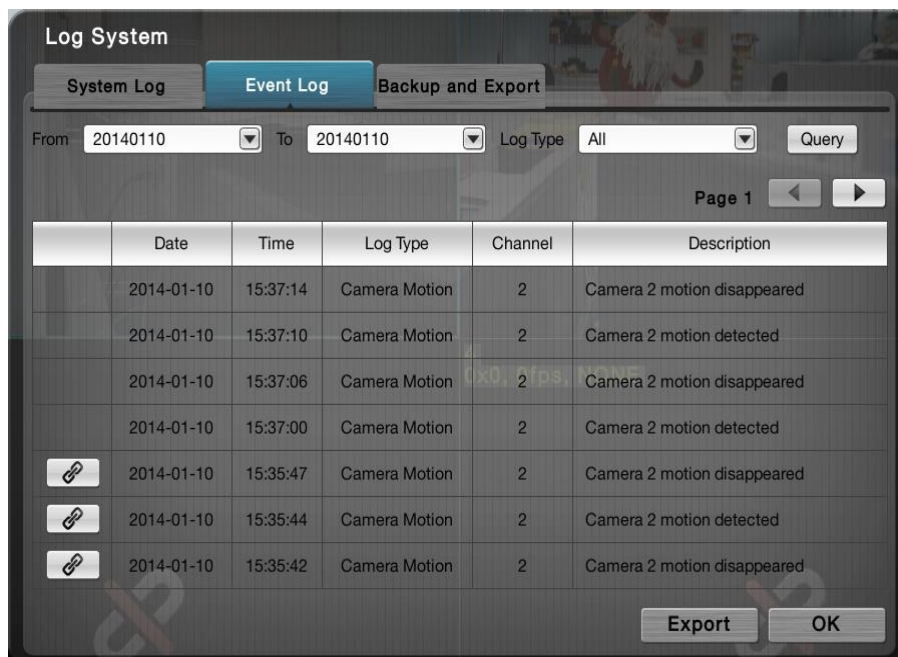

On the **Live View** screen, click menu list button  > **Main Menu** button  > **Management** button  > **Log System** button > **Event Log** tab.

The **NVR Event** tab opens and shows the history of the "Events & Actions".



The featured settings are:

Setting	Description	Default
 20121209 	Switches the history to a specific range of	The current date

	time. To switch: 1. Click the down arrow of the date box and select a specific period of time. 2. Click the down arrow of the type box and select a type of log. 3. Click the Query button.	
Page 1  	Click the right arrow button to view more logs.	--
	Click the link button to view the event playback.	--
	Click the event button to go back to view the event logs.	--



	The Event log is only recorded for the selected event(s) on the Event & Action submenu.
---	--

Click the **OK** button to quit the tab.

6.6.3.3 Backup and Export

The **Backup and Export** tab allows users to view the history of the system's exportation and backup of video files.



To access the **Backup and Export** tab:

On the **Live View** screen, click menu list button  > **Main Menu** button 
> **Management** button  > **Log System** button > **Backup and Export** tab.

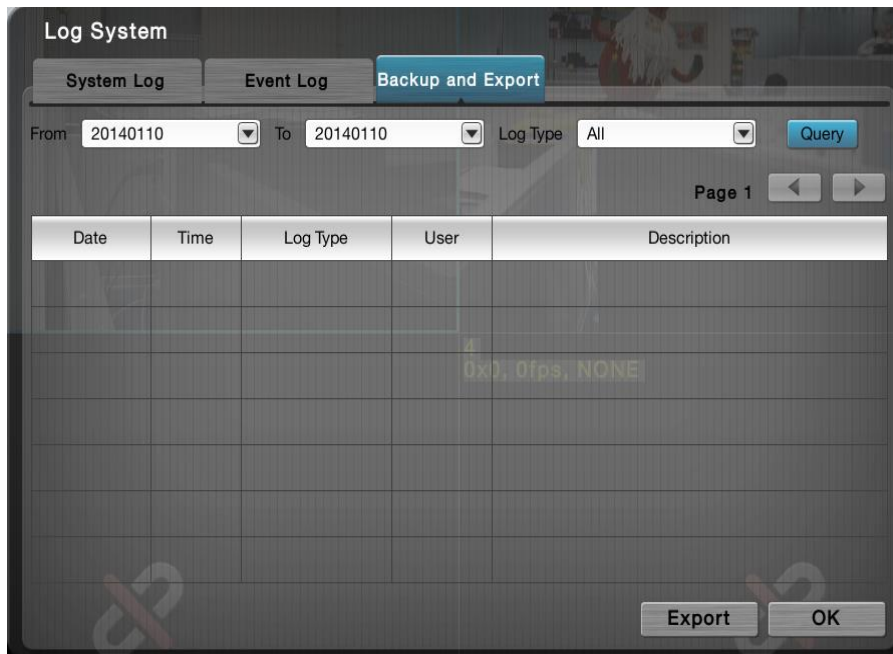
The **Backup and Export** tab opens and shows the history of videos exportation and backup on the system.



The featured settings are:

Setting	Description	Default
	Switches the history to a specific range of time. To switch: <ol style="list-style-type: none"> 1. Click the down arrow of the date box and select a specific period of time. 2. Click the down arrow of the type box and select a type of log. 3. Click the Query button. 	The current date
	Click the right arrow button to view more logs.	--

Click the **OK** button to quit the tab.

6.6.4 Save/Load Configuration

It often takes great efforts and time to tune a large number of systems to the same configuration. With the **Save/Load Configuration** submenu, the operating system supports cloning a master configuration to multiple systems with only a few clicks. The submenu also features a setting to restore the system settings to factory defaults.

To access the **Save/Load Configuration** submenu:

Open **Management** menu as described in [Management](#).

The **Management** menu opens.



Click **Save/Load Configuration** button.

The **Save/Load Configuration** submenu opens and shows the **Save Config** tab.





Save/Load Configuration submenu features three tabs: **Save Config**, **Load Config** and **Reset**, which are detailed in the following of this section.

6.6.4.1 Save Config

The **Save Config** tab saves the system settings to a configuration file.

	User accounts won't be saved to the configuration file.
---	---

To access the **Save Config** tab:

On the **Live View** screen, click menu list button  > **Main Menu** button 
> **Management** button  > **Save/Load Configuration** button > **Save Config** tab.

The **Save Config** tab will open.



The featured setting is:

Setting	Description	Default
Save Configuration	Enters the name for the configuration file. ▶ Click the keyboard icon  at the right of the field to open the virtual keyboard for text input.	"configuration"

Save the system's settings to a configuration file.

- (1) Plug a USB flash drive to one of the unit's USB ports.
- (2) Open **Save Config** tab as described above.
- (3) Enter a name for the configuration file if you want an alternate other than the default.
- (4) Click the keyboard icon  at the right of the field to open the virtual keyboard for text input.
- (5) Click the **Save** button.



In a few seconds, the system will prompt the configuration file is saved to the USB flash drive.

Click the **Exit** button to quit the tab.

6.6.4.2 Load Config

The **Load Config** tab loads a configuration file for the system to apply.

To access the **Load Config** tab:

On the **Live View** screen, click menu list button  > **Main Menu** button  > **Management** button  > **Save/Load Configuration** button > **Load Config** tab.

The **Load Config** tab will open.

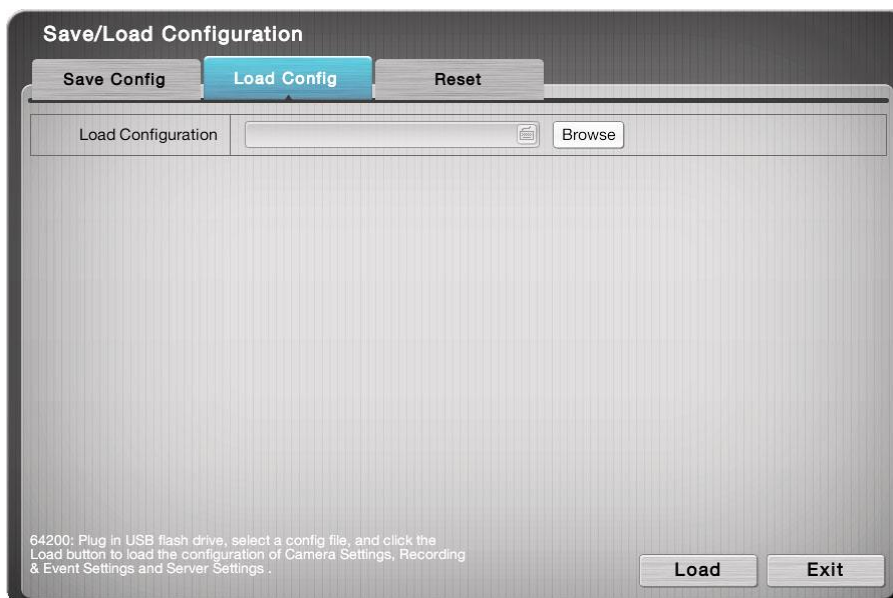

The featured setting is:

Setting	Description
Load Configuration	Browses for the configuration file to load.

Load a configuration file for the system:

- (1) Plug the USB flash drive containing the configuration file to load to one of the unit's USB ports.
- (2) Open **Load Config** tab as described above.
- (3) Click the **Browse** button. Browse for and select the configuration file to load.
- (4) Click the **Load** button.



In a few seconds, the system will prompt the configuration file is loaded.

Click the **Exit** button to quit the tab.

6.6.4.3 Reset

Use the **Reset** tab to restore all system settings to factory defaults.

To access the **Reset** tab:

On the **Live View** screen, click menu list button  > **Main Menu** button 
> **Management** button  > **Save/Load Configuration** button > **Reset** tab.

The **Reset** tab will open.

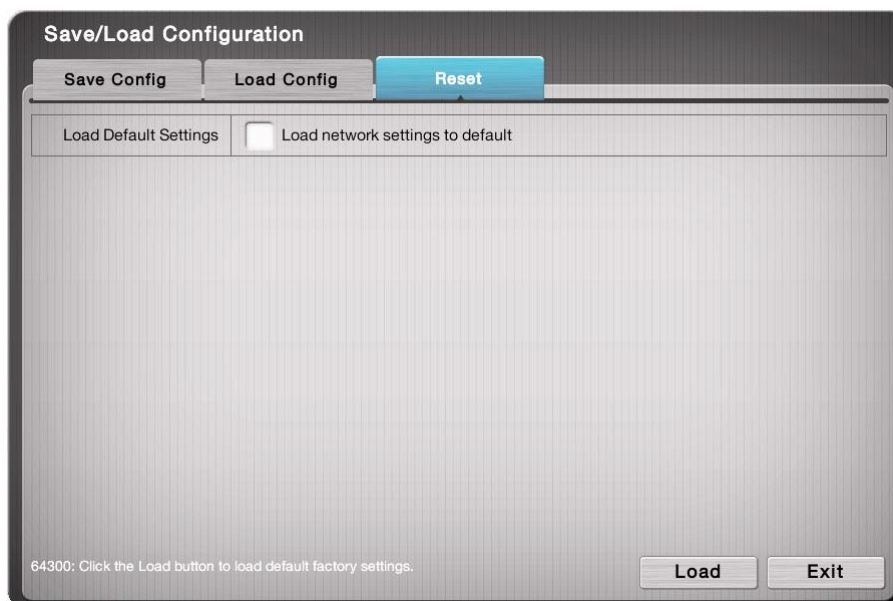

The featured setting is:

Setting	Description	Default
Load Default Settings	Restores the network settings to factory defaults. To keep the network settings, leave it deselected.	Deselected

Reset system settings to defaults:

- (1) Open the **Reset** tab as described above.
- (2) Depending on your needs, select or deselect the **Load network settings to defaults** setting.
- (3) Click **Load** button to load the defaults if you have selected **Load network settings to defaults** in step (2). The system will proceed to load the factory defaults and auto restart.

OR

Click **Exit** to quit without doing any change to the system if you haven't selected **Load network settings to defaults** in step (2).

Click the **Exit** button to quit the tab.



1. The **user accounts and their privileges** won't be erased even after default settings are loaded while the [camera settings](#), [recording schedule](#), [event & action settings](#), [Email setting](#) and [server settings](#) are otherwise.
2. **RAID information** will always be kept whether default settings or configuration are loaded.

6.7 System

Use the **System** menu to view system information, configure system settings and manage system upgrade. The menu also enables re-opening the **Install Wizard** which launches during the system's very first power-on.

To access the **System** menu:

Open the **Main Menu** as described in [Settings](#).

The **Main Menu** opens.

Click **System** button .

The **System** menu opens.

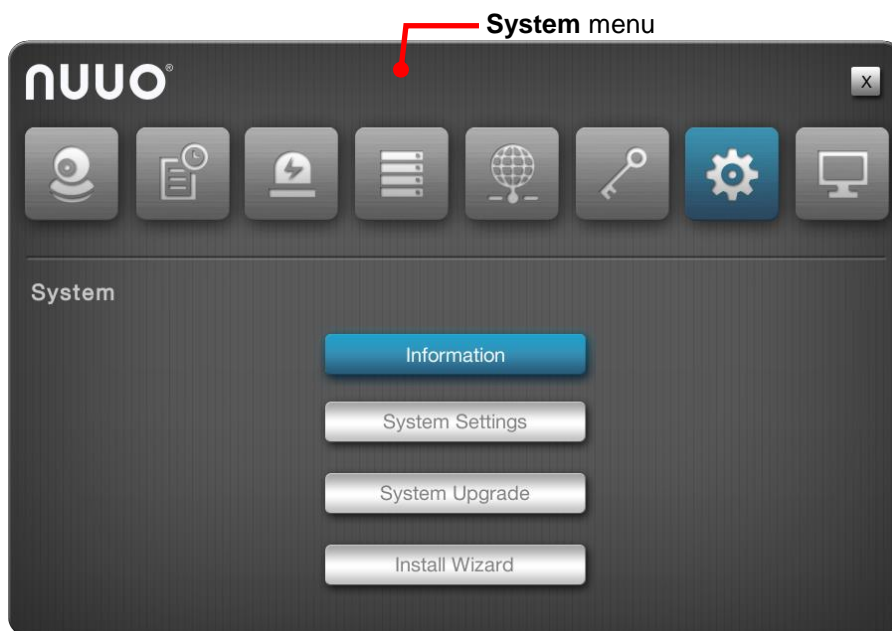

The **System** menu features four submenus, **Information**, **System Settings**, **System Upgrade** and **Install Wizard**, which are explicated in the following of this section.

6.7.1 Information

The **Information** submenu enables viewing some important system information including model, firmware, CPU and heat dissipation.

To access the **Information** submenu:

Open **System** menu as described in [System](#).

The **System** menu opens.

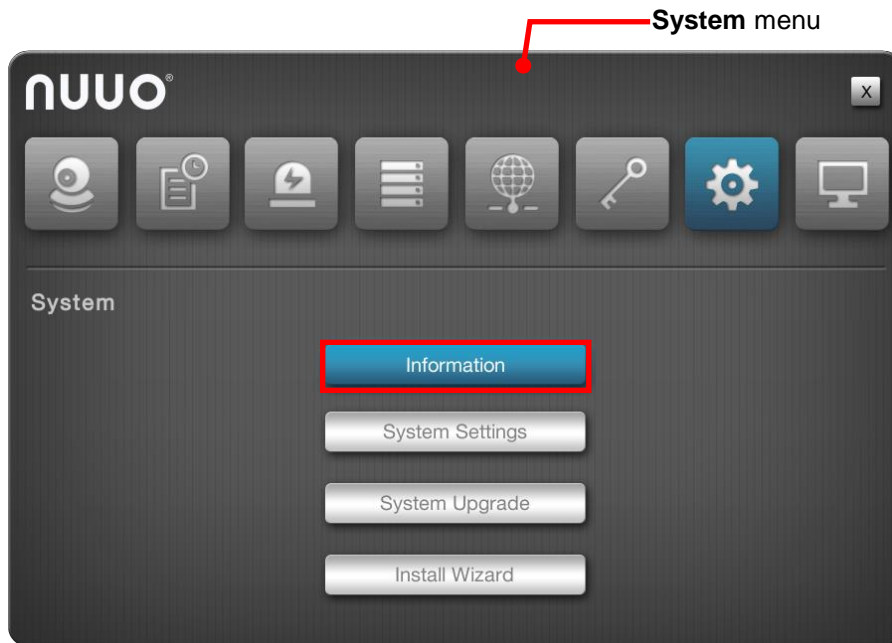

Click **Information** button.

The **Information** submenu opens and shows the **Information** tab.

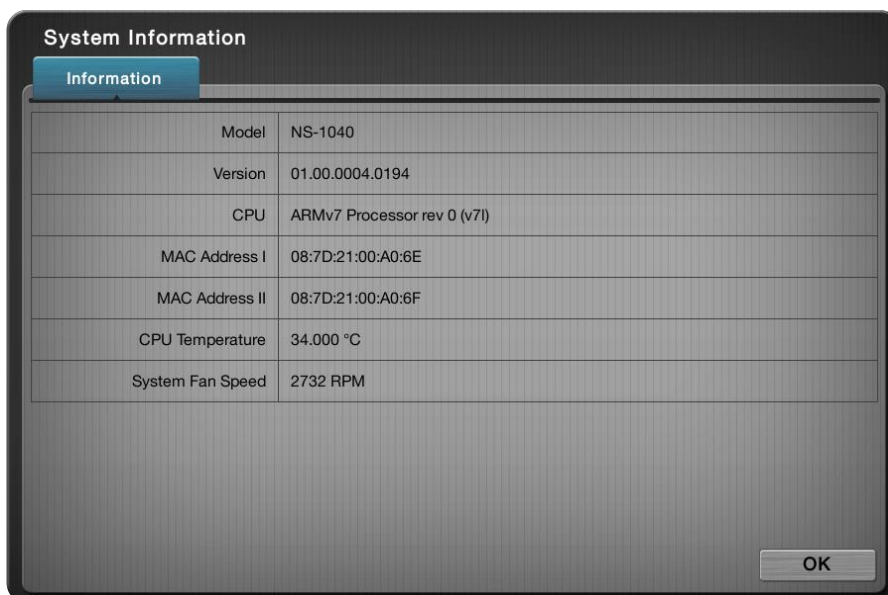



The **Information** features one tab only: **Information**, which is detailed in the following of this section.

6.7.1.1 Information

The **Information** tab delivers some important system information.

To access the **Information** tab:

On the **Live View** screen, click menu list button  > **Main Menu** button 
> **System** button  > **Information** button > **Information** tab.

The **Information** tab will open.

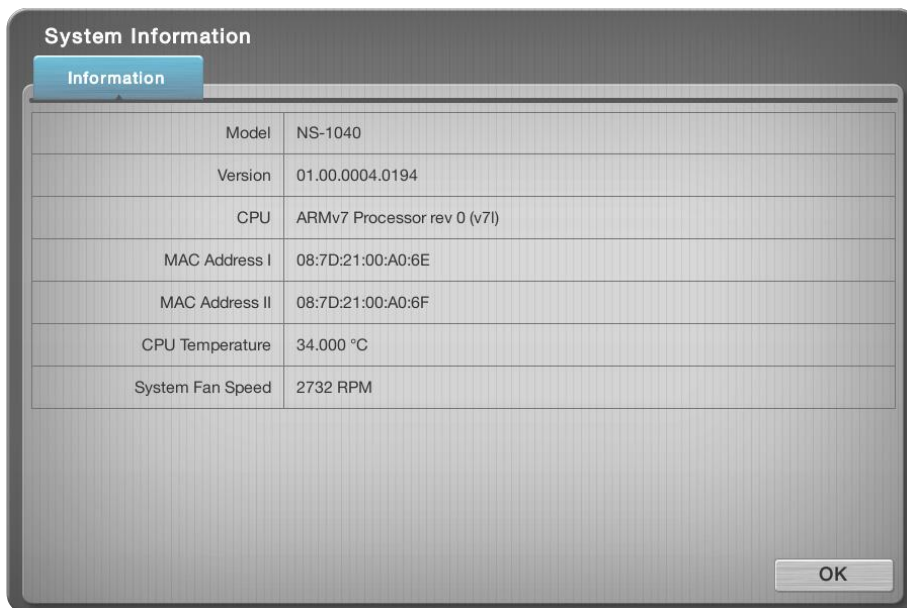

The information delivered is:

Info	Description
Model	Delivers the system's model name.
Version	Delivers the system version.
CPU	Delivers the CPU model number.
MAC Address I	Delivers the system's MAC address.
MAC Address II	Delivers the system's MAC address.
CPU Temperature	Delivers CPU temperature.
System Fan Speed	Delivers system fan speed.

Click the **OK** button to quit the tab.

6.7.2 System Settings

Use the **System Settings** submenu to configure and optimize the system for your applications.

To access the **System Settings** submenu:

Open **System** menu as described in [System](#).

The **System** menu opens.



Click **System Settings** button.

The **System Settings** submenu opens and shows the **General** tab.

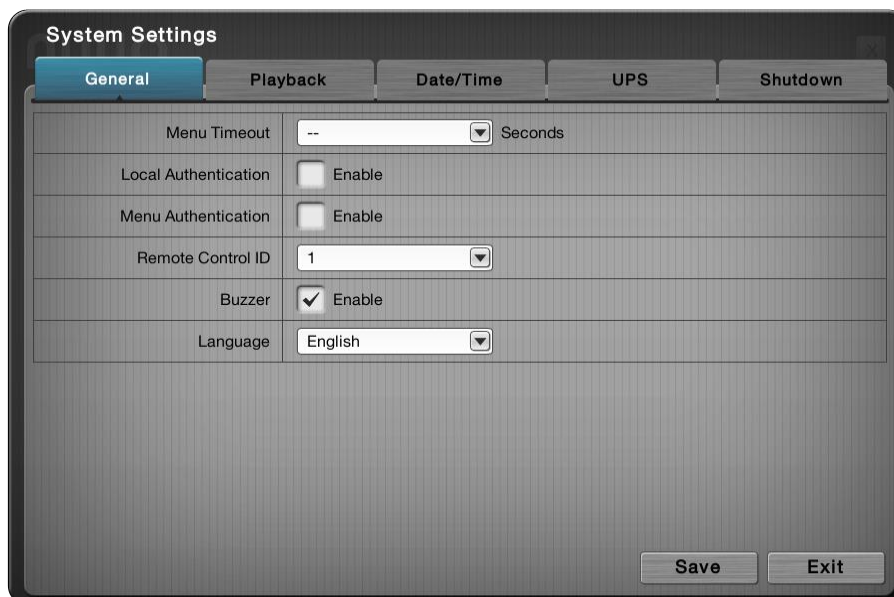



The **System Settings** submenu features five tabs **General**, **Playback**,

Date/Time, UPS and **Shutdown**, which are explicated one-by-one in the following of this section.

6.7.2.1 General

As the name suggests, the **General** tab configures some general system settings such as the timeout of **Main Menu**, language for the operating system’s user interface, the access security and also the buzzer control.

To access the **General** tab:

On the **Live View** screen, click menu list button  > **Main Menu** button  > **System** button  > **System Settings** button > **General** tab.

The **General** tab will open.

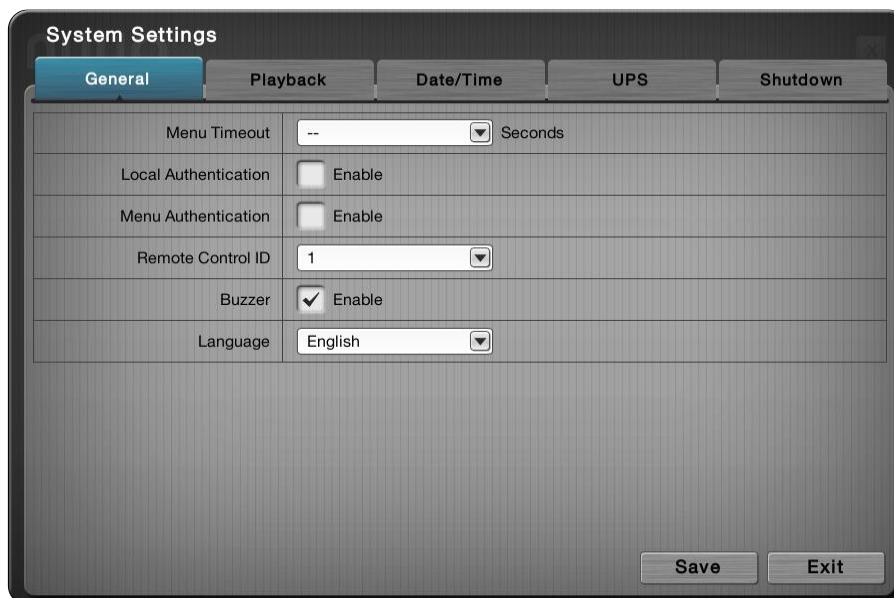

The featured settings are:

Setting	Description	Default
Menu Timeout	Defines the time to deactivate the Main Menu that has been idle.	600 Seconds
Local Authentication	Enables/disables login security for local access. ▶ If enabled, the operating system will ask for the username and password at system login.	Selected (Enabled)
Menu Authentication	Enables/disables login security for the Main Menu . ▶ If enabled, the operating system will ask for the username and password at user’s attempt to access the Main Menu .	Selected (Enabled)

Remote Control ID	Selects the ID of this server to control multiple NVR servers separately by single IR remote control. ▶ When there are multiple NVR devices aligned together, the operator can give each device server ID from 1 to 9, and switch ID on remote control to control different NVR servers separately. There won't be any signal conflict.	1
Buzzer	Enables/disables the built-in buzzer. ▶ The unit is built in with a buzzer which sounds whenever the unit finishes starting or when a problem is detected. ▶ It is recommended that this buzzer should be enabled.	Selected (Enabled)
Language	Sets the language used on the operating system. ▶ The system needs to restart.	English



Click the **Save** button to apply the change(s).

Click the **Exit** button to quit the tab.

6.7.2.2 Playback

Use the **Playback** tab to define how to replay an instant video footage and how much time to jump when skipping a recorded video backwards or forwards.

To access the **Playback** tab:

On the **Live View** screen, click menu list button  > **Main Menu** button 
> **System** button  > **System Settings** button > **Playback** tab.

The **Playback** tab will open.

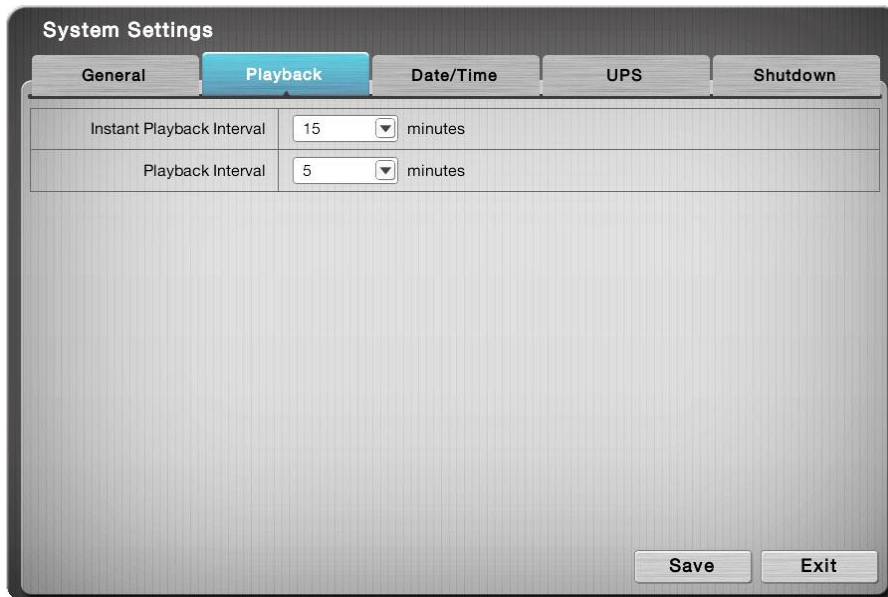

The featured settings are:

Setting	Description	Default
Instant Playback Interval	Defines a time that Instant Playback starts from prior to the current moment.	15 minutes
Playback Interval	Defines a period of time for the Next Interval and the Previous Interval function of Playback .	5 minutes

Click the **Save** button to apply the change(s).

Click the **Exit** button to quit the tab.

6.7.2.3 Date/Time

Use the **Date/Time** tab to configure the date, time, time zone of your locale and other time-related parameters for the operating system.

To access the **Date/Time** tab:

On the **Live View** screen, click menu list button  > **Main Menu** button 

> **System** button  > **System Settings** button > **Date/Time** tab.

The **Date/Time** tab will open.

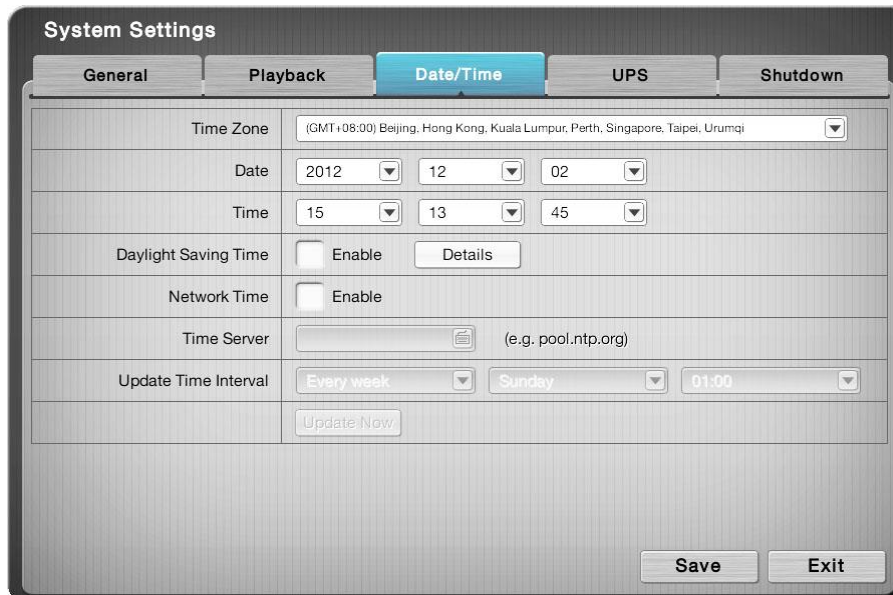

The featured settings are:

Setting	Description	Default												
Time Zone	Sets the time zone of your locale.	GMT+08:00												
Date	Sets system date.	--												
Time	Sets system time.	--												
Daylight Saving Time	<p>Enables/disables daylight saving time.</p> <ul style="list-style-type: none"> When enabled, the Daylight Saving Time dialog auto opens to provide the advanced settings for daylight saving time including the following: <table border="1"> <thead> <tr> <th>Setting</th> <th>Description</th> <th>Default</th> </tr> </thead> <tbody> <tr> <td>Adjust clock</td> <td>Defines how much time should the system time be adjusted forward/backward for.</td> <td>+ 2 hours</td> </tr> <tr> <td>Start time</td> <td>Defines the date to start applying daylight saving time.</td> <td>January the 1st</td> </tr> <tr> <td>End time</td> <td>Defines the date to stop applying daytime saving time.</td> <td>January the 1st</td> </tr> </tbody> </table> <ul style="list-style-type: none"> If the Daylight Saving Time dialog is closed, click the Details button to open it. 	Setting	Description	Default	Adjust clock	Defines how much time should the system time be adjusted forward/backward for.	+ 2 hours	Start time	Defines the date to start applying daylight saving time.	January the 1st	End time	Defines the date to stop applying daytime saving time.	January the 1st	Deselected (Disabled)
Setting	Description	Default												
Adjust clock	Defines how much time should the system time be adjusted forward/backward for.	+ 2 hours												
Start time	Defines the date to start applying daylight saving time.	January the 1st												
End time	Defines the date to stop applying daytime saving time.	January the 1st												
Network Time	<p>Enables/disables the synchronization with NTP server for the correct time.</p> <ul style="list-style-type: none"> When enabled, the Date and Time settings become unavailable. 	Deselected (Disabled)												
Time Server	<p>Sets the time server name or IP address.</p> <ul style="list-style-type: none"> This setting is only available when Network Time is enabled. Click the keyboard icon  to open the virtual keyboard for text input. 	--												
Update Time	Sets how often to synchronize the system with the	Weekly on												

Interval	time server. <ul style="list-style-type: none"> ▶ This setting is available only when Network Time is enabled. ▶ Click the Update Now button to immediately update the system time. 	Sunday, at 01:00 o'clock
----------	--	--------------------------

	The system will restart right after synchronization, meaning no video will be recorded during this period. So choose the update interval carefully.
---	---



Click the **Save** button to apply the change(s).

Click the **Exit** button to quit the tab.

6.7.2.4 UPS

If the unit is used with an UPS module, it is able to deal with accidental power failure or unstable power supply. The **UPS** tab configures how the system reacts to such scenario by defining the timing for auto shutdown. This tab also delivers the info about the UPS module used.

To access the **UPS** tab:

On the **Live View** screen, click menu list button  > **Main Menu** button 
 > **System** button  > **System Settings** button > **UPS** tab.

The **UPS** tab will open.

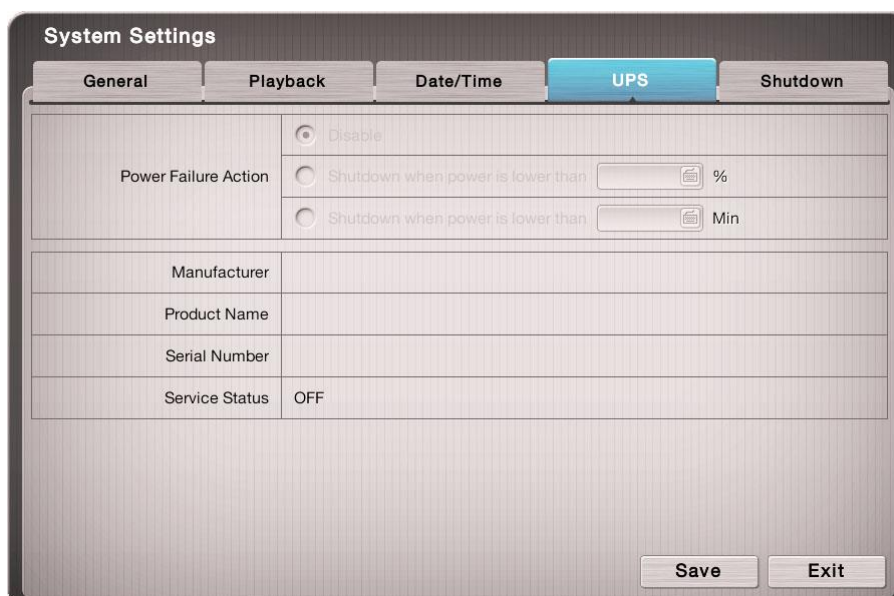



The settings on the **UPS** tab are available only when an UPS module is connected.

The featured settings and delivered info are:

Group	Setting	Description	Default
Power Failure Action	Disable	Enables/disables the operating system's actions to deal with power failure.	Selected (Disabled)
	Shutdown when power is lower than _ %	Sets how low does the UPS battery power drain down to before the operating system shuts down itself.	--
	Shutdown when power is lower than _ Min	Sets how long should the unit run on UPS battery power before the operating system shuts down itself.	--
UPS Info	Manufacturer	Delivers the manufacturer of the UPS module.	--
	Product Name	Delivers the product names of the UPS module.	--
	Serial Number	Delivers the serial number of the UPS module.	--
	Services Status	Delivers if the UPS module is servicing.	--



For **Power Failure Action**, an USB connection is needed between the unit and the UPS to check the status of UPS.



Click the **Save** button to apply the change(s).

Click the **Exit** button to quit the tab.

6.7.2.5 Shutdown

Use the **Shutdown** tab to safely turn off the unit or restart the operating system.

To access the **Shutdown** tab:

On the **Live View** screen, click menu list button  > **Main Menu** button 
 > **System** button  > **System Settings** button > **Shutdown** tab.

The **Shutdown** tab will open.

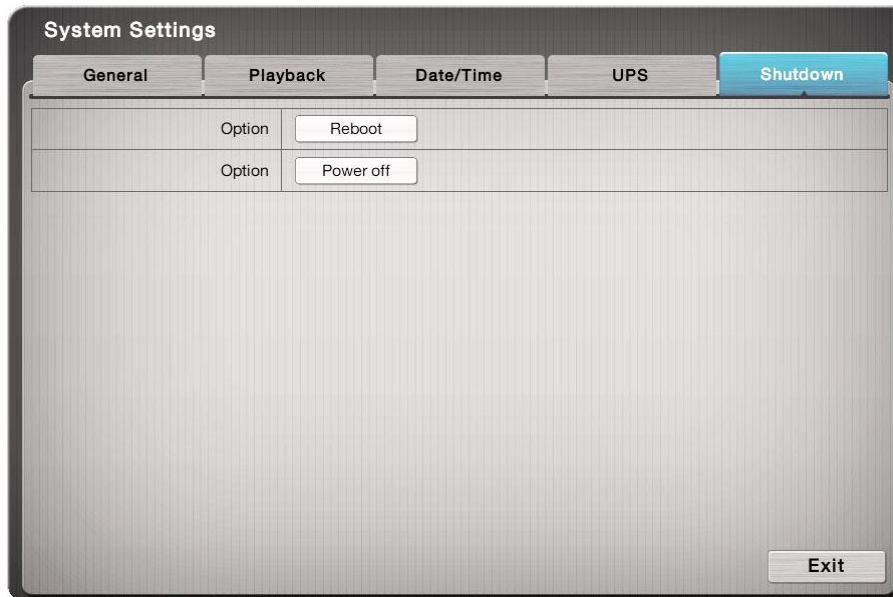

The featured commands are:

Command	Description
Reboot	Stops all services and restarts the operating system. <ul style="list-style-type: none">▶ A dialog will open asking for confirmation. Click Yes to continue or click No to return to the operating system.
Power off	Stops all service and safely turn off the unit. <ul style="list-style-type: none">▶ A dialog will open asking for confirmation. Click Yes to continue or click No to return to the operating system.

Click the **Exit** button to quit the tab.

6.7.3 System Upgrade

The **System Upgrade** deals with the matters about upgrading the operating system. Access this tab to update the system firmware to the latest version for better performance of the operating system.

To access the **System Upgrade** submenu:

Open **System** menu as described in [System](#).

The **System** menu opens.

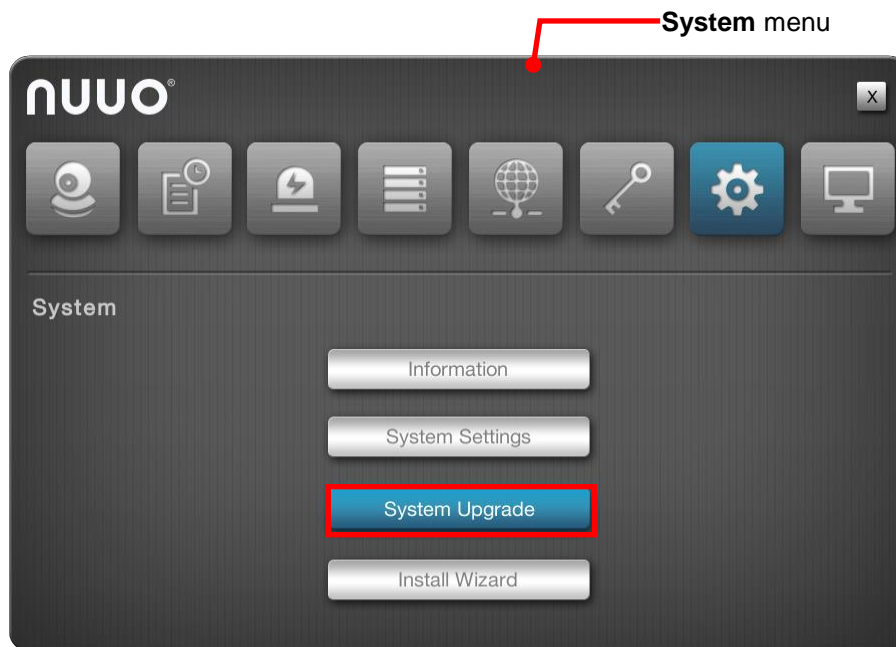

Click **System Upgrade** button.

The **System Upgrade** submenu opens and shows the **System Upgrade** tab.

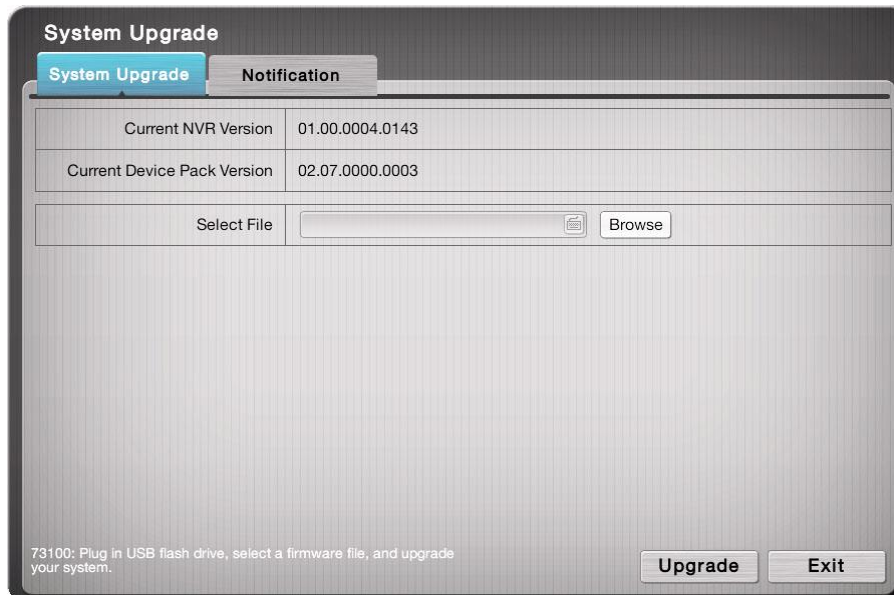



The **System Upgrade** submenu features two tabs, the **System Upgrade** and **Notification** tabs which are detailed in the following of this section.

6.7.3.1 System Upgrade

Exactly as the title advertises, the **System Upgrade** tab enables system upgrade to bring the operating system to a newer version that promises better performance or new functions. Besides, this tab also delivers the current firmware version and device pack version.

To access the **System Upgrade** tab:

On the **Live View** screen, click menu list button  > **Main Menu** button  > **System** button  > **System Upgrade** button > **System Upgrade** tab.

The **System Upgrade** tab will open.

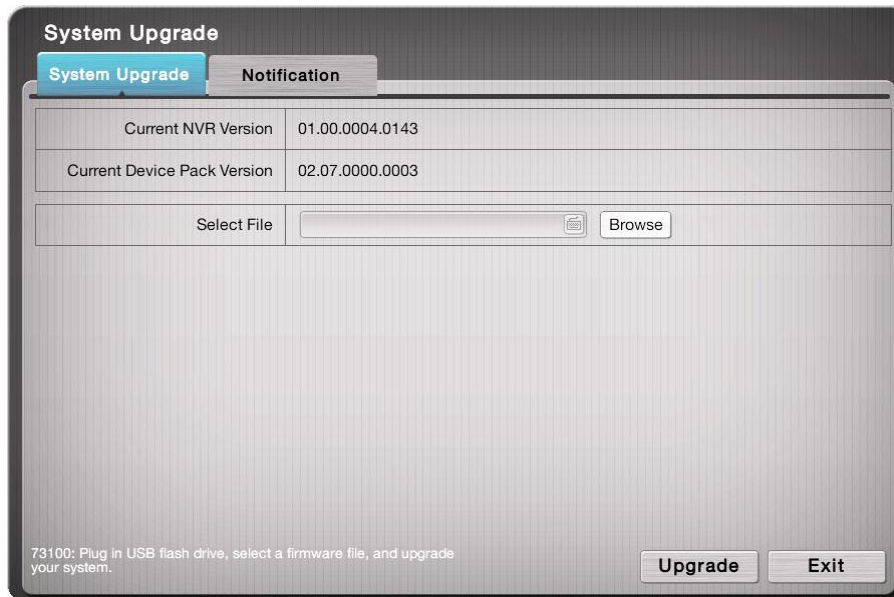

The featured facility and delivered info are:

Info / Facility	Description
Current NVR Version	Delivers current firmware version of the operating system.
Current Device Pack Version	Delivers current device pack version.
Select File (and the Browse button)	Browses for the firmware and runs the upgrade.

Upgrade the system by the steps below if a newer release of the system firmware is available:

- (1) Copy the firmware to an USB flash drive.
- (2) Plug the USB flash drive to any of the system's USB ports.
- (3) Open the **System Upgrade** tab on the system as described above.
- (4) Click the **Browse** button. Browse for the firmware and select the firmware. Click **OK** button.



- (5) Click the **Upgrade** button.
A dialog opens to ask for confirmation of the upgrade.
- (6) Click **Yes** to confirm upgrade or click **No** to quit.
The upgrade starts, progresses and finishes within a few minutes.

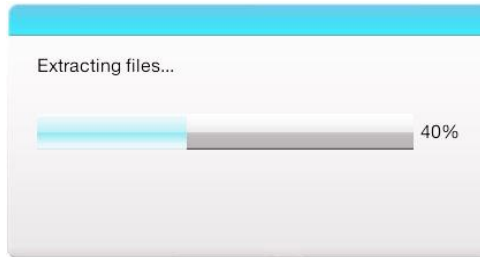



Then the system auto restarts and gets ready for use.

	Please do not power off the server while system upgrading.
---	--

6.7.3.2 Notification

The **System Upgrade** tab enables the auto notification whenever a firmware is released for your updates (recommended). Firmware update helps to keep your system up to date. The updater will collect info from your system for the manufacturer's system improvement references.

To access the **Notification** tab:

On the **Live View** screen, click menu list button  > **Main Menu** button 
> **System** button  > **System Upgrade** button > **Notification** tab.

The **Notification** tab will open.

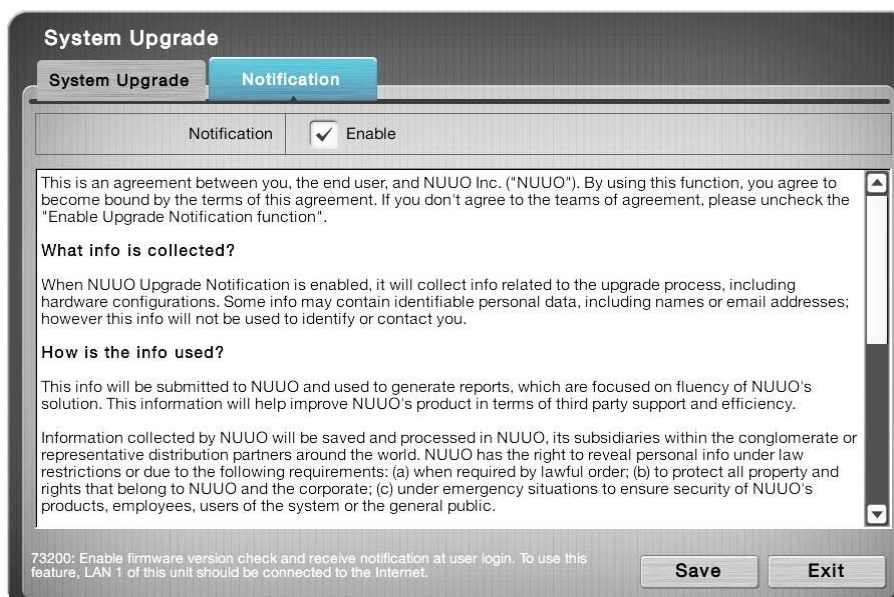

The featured setting is:

Setting	Description	Default
Notification	<p>Enables/disables the check of firmware version and the notification of system upgrade.</p> <ul style="list-style-type: none">▶ When enabled, users are able to receive the notification of an available firmware update when login to the system.▶ In v1.0, this function requires the system to be online by the LAN1 port connected to the Internet.▶ As the updater will collect info from your system for the manufacturer's system improvement references, read the agreement between you and the manufacturer. By enabling the feature, you agree on the manufacture's info collection from your system.	Selected (Enabled)

Click the **Save** button to apply the change(s).

Click the **Exit** button to quit the tab.

6.7.4 Install Wizard

Access the **Install Wizard** submenu to reopen the **Install Wizard** if it is skipped during the first power-on of the system.

To relaunch the **Install Wizard**:

Open **System** menu as described in [System](#).

The **System** menu opens.

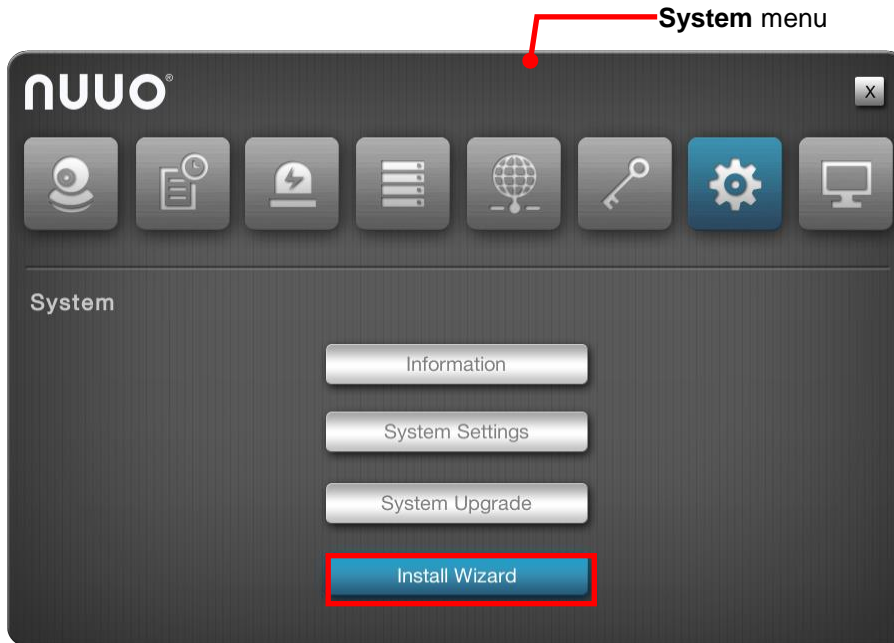

Click **Install Wizard** button.

The **Install Wizard** submenu opens and shows the **Wizard** tab.



Click the lower-right **Start** button.

In a few seconds, the **Install Wizard** opens.

See [Install Wizard](#) for the follow-ups.

6.8 Display

Use the **Display** menu to configure the system's display parameters, including display layout, monitor resolution and other onscreen elements.

To access the **Display** menu:

Open the **Main Menu** as described in [Settings](#)

The **Main Menu** opens.

Click **Display** button .

The **Display** menu opens.



6.8.1 Monitor Settings

Use the **Display** menu to configure the system's display parameters, including display layout, monitor resolution, monitor layout (Main & second) other onscreen elements.

To access the **Display** menu:

Open the **Main Menu**

Click **Display button** .

Click **Monitor Settings**

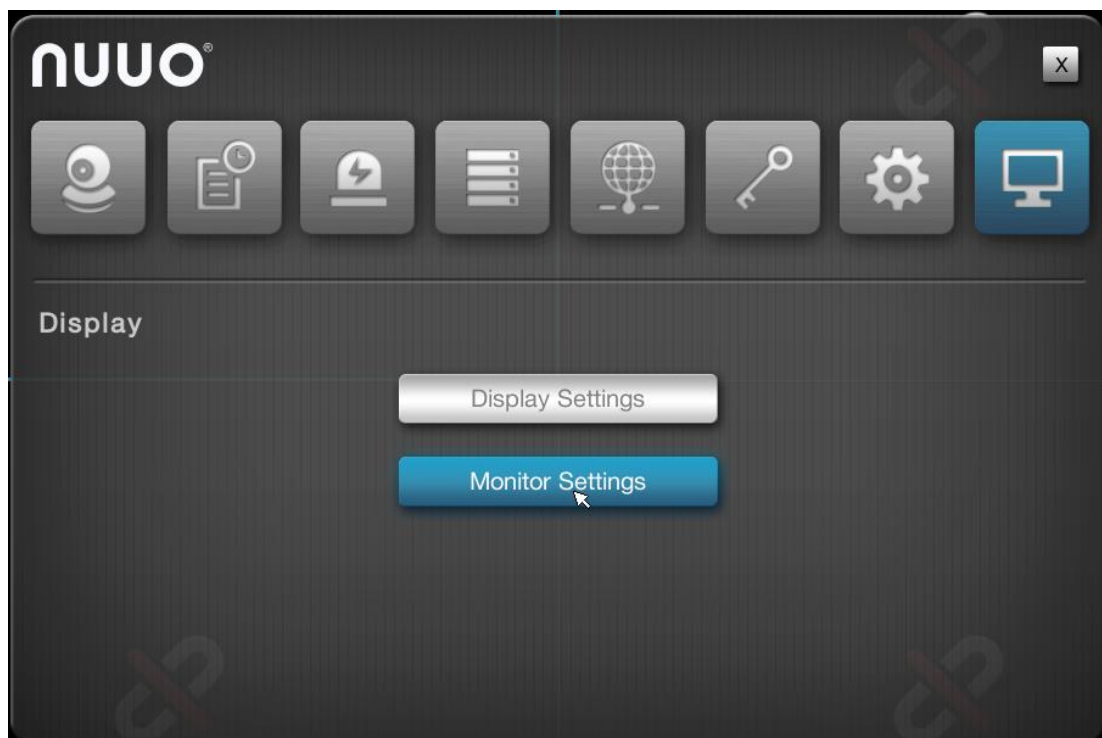

The Monitor settings submenu opens as following

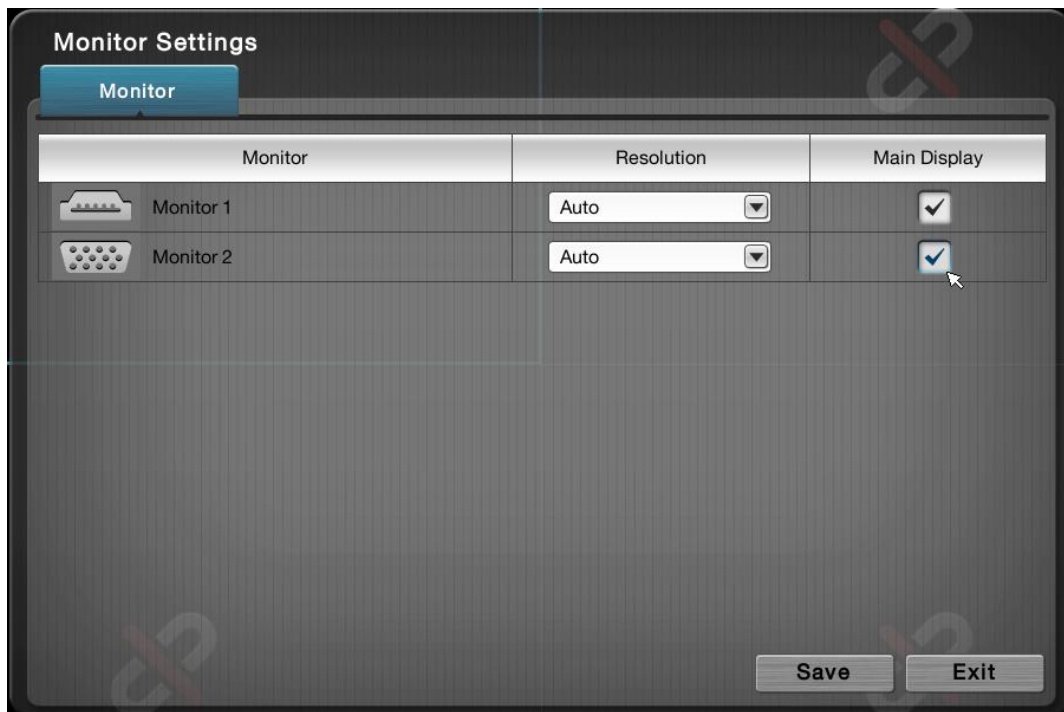

In this page, system allows user to choose both VGA & HDMI as Main Display in the meantime.

If user wants to use HDMI as main display, tick off main Display for VGA monitor (Monitor 1), and VGA monitor will become **secondary display**.





Setting	Description	Default
Resolution	Sets the resolution of the display monitor connected to the system, or leaves it on the system's auto detection. Options available are: Auto , 1024x768 , 1280x720 , 1280x1024 and 1920x1080 .	Auto

6.8.2 Display Settings

The **Display Settings** submenu configures the system's display monitor, the presentation of the onscreen **Video Area**, **Status Bar** and so on.

To access the **Display Settings** submenu:

Open **Display** menu as described in [Display](#).

The **Display** menu opens.

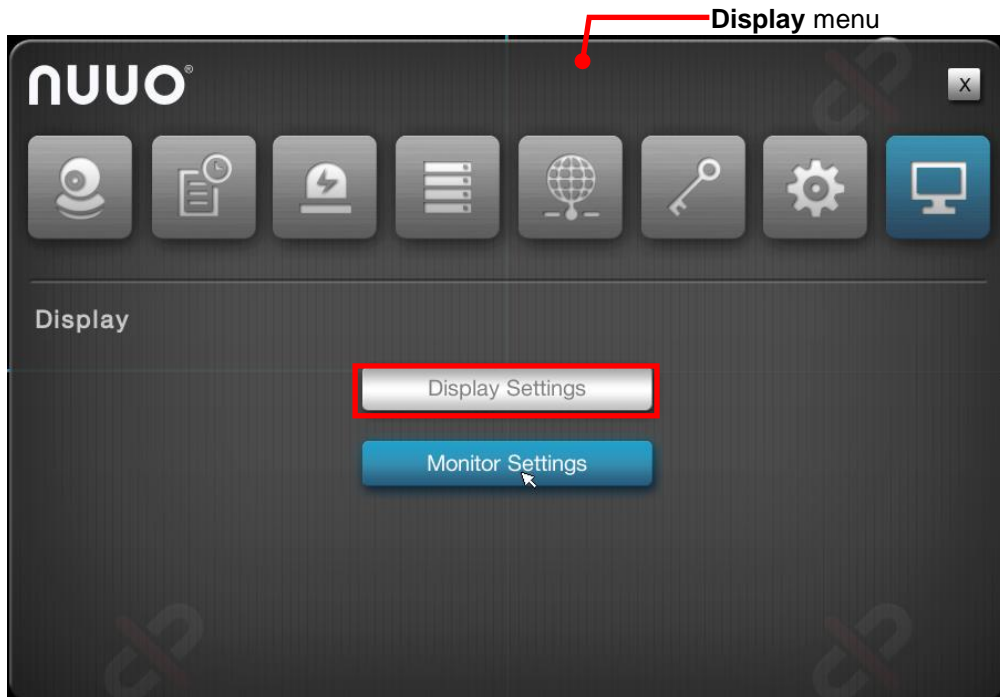

Click **Display Settings** button.

The **Display Settings** submenu opens and shows the **Display** tab.

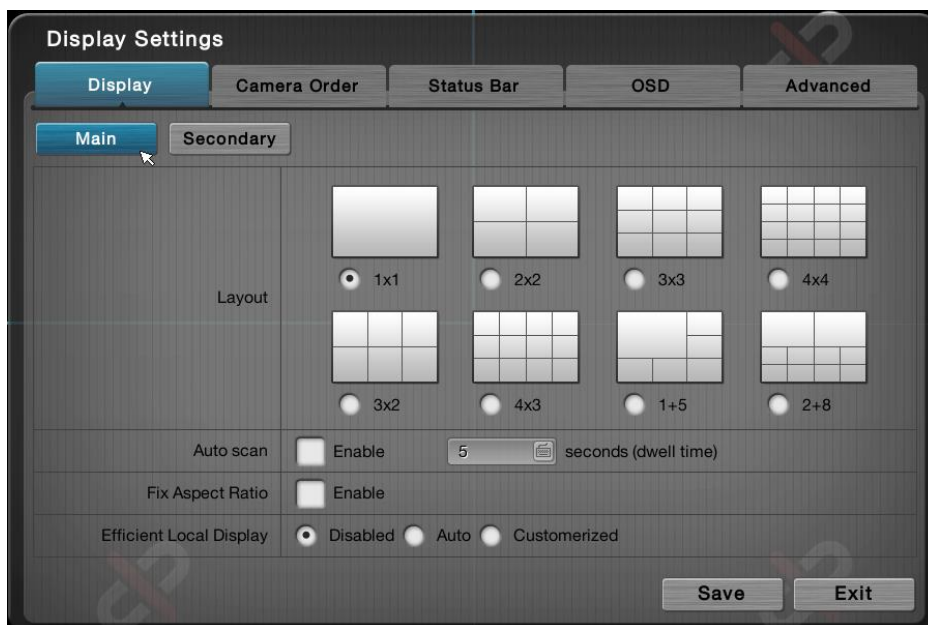



The **Display Settings** submenu features five tabs: **Display**, **Camera Order**, **Status Bar**, **OSD** and **Advanced**, which are detailed in the following of this section.

6.8.2.1 Display

Use the **Display** tab to configure how the videos area are presented onscreen.

To access the **Display** tab:

On the **Live View** screen, click menu list button  > **Main Menu** button 
> **Display** button  > **Display Settings** button > **Display** tab.

The **Display** tab will open.

In this page, user can modify the layout for both Main and Secondary monitors.

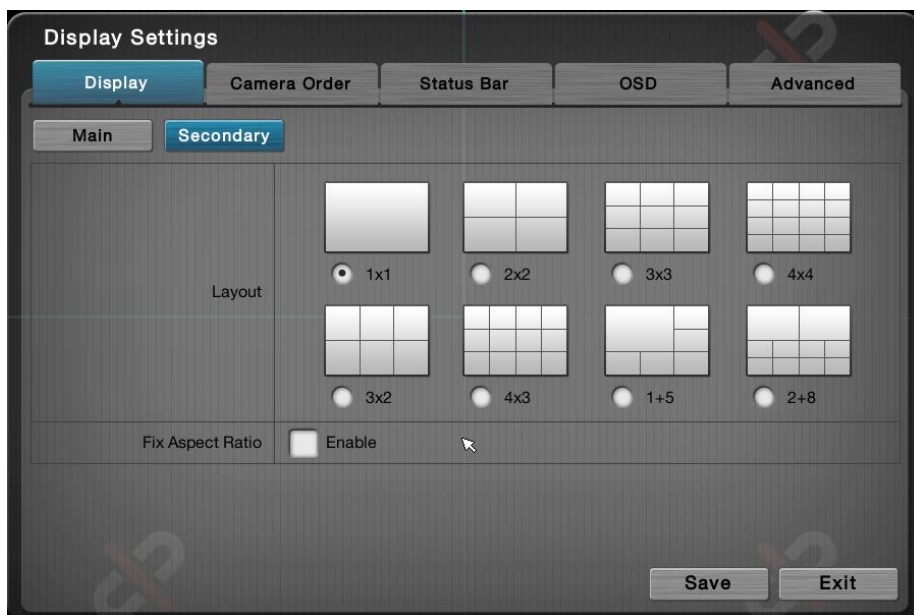
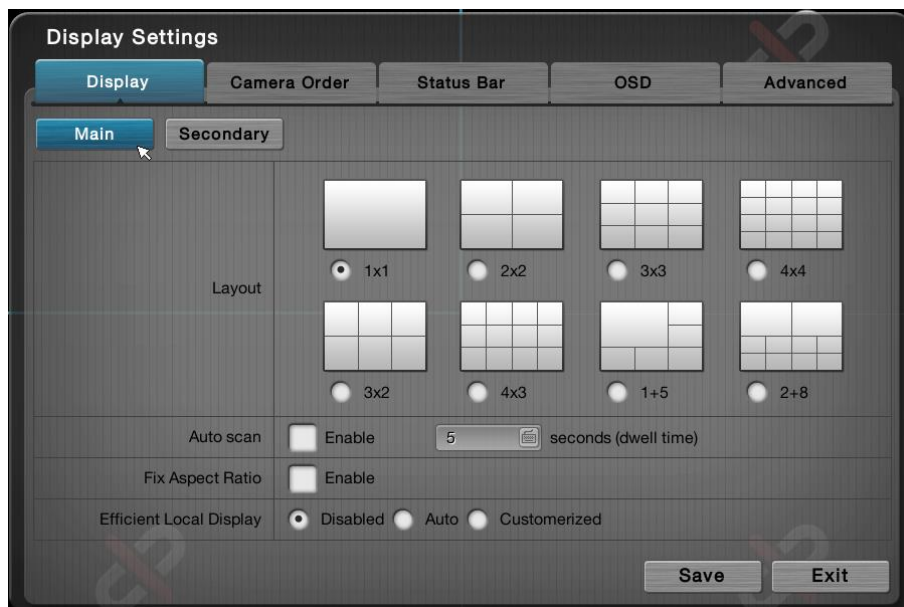

In Secondary display, some features are limited.

The featured settings are:

Setting	Description	Default
Layout	Sets the default (multi-split) layout to show the video channels on Live View screens. The available layout selection depends on models.	1x1
Auto Scan	<p>Enables/disables slide-showing multiple video channel(s) on the Live View screens. For instance, select 4-split (2x2) layout to view all 8 video channels by viewing 4 video channels at one time onscreen.</p> <ul style="list-style-type: none"> ▶ When enabled, the seconds (dwell time) setting becomes available. Define how long each group of video channels shows onscreen at each turn. ▶ For the seconds (dwell time) setting, click the keyboard icon  at the right of the field to open the virtual keyboard for text input. 	Deselected (Disabled)
Fix Aspect Ratio	Enables/disables fixing the ratio of video source instead of fitting the video on every grid.	Deselected (Disabled)
Efficient Local Display	<p>Enable as "Auto" to save CPU loading by applying low stream profile on small grids automatically. Enabled as "Customize", you may customize the stream profile on the right top of live view manually.</p> <ul style="list-style-type: none"> ▶ Also see Live View Video Area for stream override configuration. 	Disabled

Click the **Save** button to apply the change(s).

Click the **Exit** button to quit the tab.

6.8.2.2 Camera Order

Use the **Camera Order** tab change the order of video channels to show on the **Live View** screens for both monitors.

To access the **Camera Order** tab:

On the **Live View** screen, click menu list button  > **Main Menu** button 

> **Display** button  > **Display Settings** button > **Camera Order** tab.

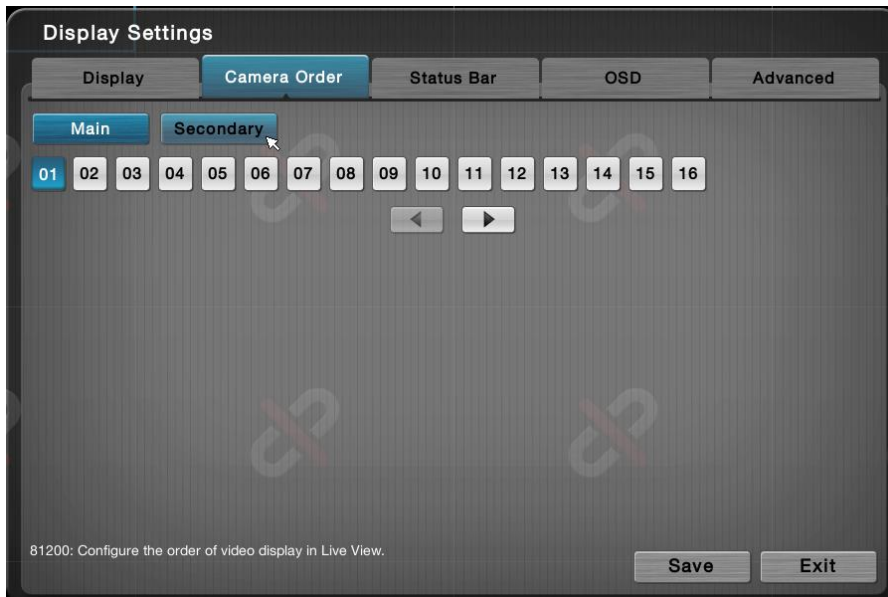

The **Camera Order** tab will open.



Change the order of a video channel:

- (1) Select a video channel. (01 02 03 04)

The selected channel becomes highlighted in blue color (01 02 03 04).

- (2) Click the left arrow key  or right arrow key  to advance or withdraw the channel's order among the available video channels.

OR

When using the **IR Remote Control**, use the navigation keys to move between the highlight item and hit Enter key to make selection or triggers operation. See [IR Remote Control](#) to know more about the operation of the IR Remote Control.



Click the **Save** button to apply the change.

Click the **Exit** button to quit the tab.

6.8.2.3 Status Bar

Use the **Status Bar** tab to control the presentation of the **Status Bar** and also the information delivered by the **Status Area**. See also [Status Bar](#) and [Status Bar](#).



To access the **Status Bar** tab:

On the **Live View** screen, click menu list button  > **Main Menu** button  > **Display** button  > **Display Settings** button > **Status Bar** tab.

The **Status Bar** tab will open.



The featured settings are:

Setting	Description	Default
Status Bar	Sets how to show the Status Bar onscreen. ▶ Select Automatically hide to hide the Status Bar after its idleness for 15 seconds	Always show
IP Address	Enables/disables the Status Area to/from showing the IP addresses of the systems and the cameras. ▶ See also Status Area .	Selected (Enabled)
Date	Enables/disables the Status Area and Time Bar to/from showing system date. ▶ Click the down arrow  to select a date format from the drop-downs. ▶ See also Status Area and Time Bar .	Selected (Enabled)
Time	Enables/disables the Status Area and Time Bar to/from showing system time. ▶ Click the down arrow  to select a time format from the drop-downs. ▶ See also Status Area and Time Bar .	Selected (Enabled)



Click the **Save** button to apply the change(s).

Click the **Exit** button to quit the tab.

6.8.2.4 OSD

Use the **OSD** tab to configure the system's "on-screen" displaying.

To access the **OSD** tab:

On the **Live View** screen, click menu list button  > **Main Menu** button 
> **Display** button  > **Display Settings** button > **OSD** tab.

The **OSD** tab will open.

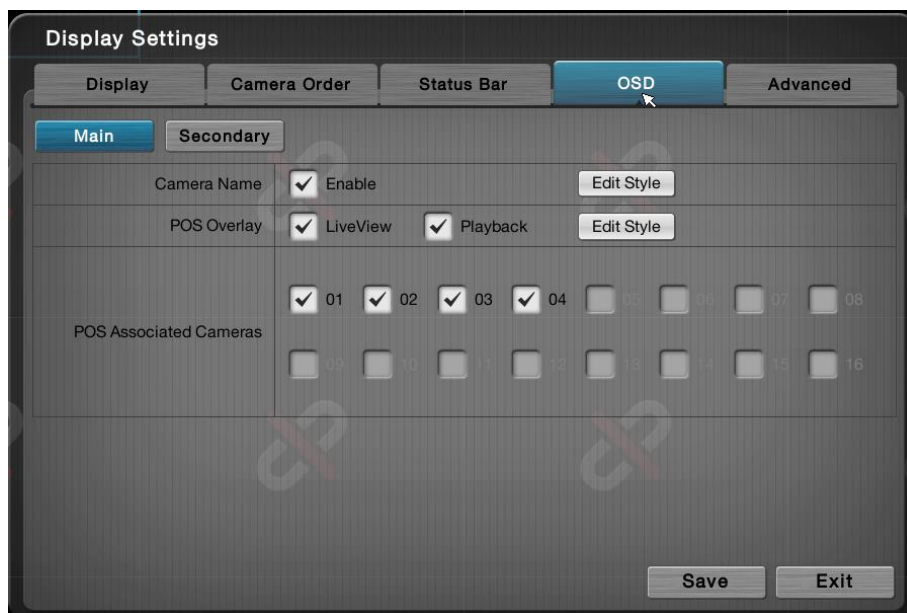

The featured settings are:

Setting	Description	Default
Camera Name	<p>Enables/disables showing the camera name in the upper-left corner of the video channel's Video Area.</p> <ul style="list-style-type: none"> ▶ Click the Edit Style button to change the font and style to show the camera name. ▶ See also Video Area for the Live View screen and Video Area for the Playback screen. 	Selected (Enabled)
POS Overlay	<p>Enables/disables POS transaction data on a played video.</p> <ul style="list-style-type: none"> ▶ Select Live View to enable replaying an instant video footage with POS transaction data on the Live View screen. ▶ Select Playback to enable playing a recorded video with POS transaction data on the Playback screen. ▶ Click the Edit Style button to change the font and style of the displayed data as well as the data dwell time. ▶ Go to web for more detailed settings about POS transaction data. 	All selected (All enabled)
POS Associated Cameras	<p>Enables/disables POS Overlay for a video channel.</p> <ul style="list-style-type: none"> ▶ Go to web for more detailed settings about POS transaction data. 	All selected (All enabled)

In Secondary monitor, some features are limited.



Click the **Save** button to apply the change(s).

Click the **Exit** button to quit the tab.

6.8.2.5 Advanced

Use the **Advanced** tab to set the resolution of the display monitor that is connected to the system, or leaves it on the system's auto detection. And other sophisticated settings are also available in this page.

To access the **Advanced** tab:

On the **Live View** screen, click menu list button  > **Main Menu** button 
 > **Display** button  > **Display Settings** button > **Advanced** tab.

The **Advanced** tab will open.



The featured setting is:

Setting	Description	Default
Snapshot	Enables to attach a full channel screenshot with the snapshot of focused channel. The higher resolution of cameras connected, the more time it takes to finish the snapshot process.	Unchecked
Event Pop-up	When event is triggered (motion detection and camera I/O only), local live view display the event camera as 1x1 display. Pop-up time can be adjusted: Auto / 5 / 10 / 30 / 60 seconds.	Unchecked (Auto)

Click the **Save** button to apply the change(s).

Click the **Exit** button to quit the tab.

	<p>If the length of your HDMI/VGA is over 1M, add a "repeater" to strengthen the signal.</p> <p>When the UI/video image isn't at the correct location, correct it by the "auto adjust" function on the monitor or adjust it manually.</p>
---	---

7 IR Remote Control



Save for the USB keyboard and USB mouse, the unit works with an **IR Remote Control**, which comes with the unit. In the following of this chapter, you will be guided to each key and its function.











Key layout of the IR Remote Control























 Battery spec is 1.5V, AAA, R03. Two batteries are required for a remote control.

IR Remote Control - Functions Summary:

Group	Key	Description	Function
--		Power key	Powers off the system. ▶ The system will ask for administrator’s password for power-off. Only the administrator is able to power off the system by the IR Remote Control .
--		Switch ID	Switch the server ID of this remote control to control multiple NVR servers separately by single IR remote control. ▶ Press this key and a number button (1~9) simultaneously to

			switch server ID of this remote control.
Playback Keypad		Stop	Stops playing. <ul style="list-style-type: none"> ▶ This key is only applicable to the Playback screen. ▶ The playback stops by showing the frame where the video starts. ▶ Whether the video is being fast-forwarded or reverse-played at the moment, press Stop key will restore the playback speed to x1.
		Play / Pause	Delivers different functions in Live View and Playback . <ul style="list-style-type: none"> ▶ Live View: Starts the Instant Playback ▶ Playback: Starts or halts the playing.
		Fast-Forward	Hit once to fast-forward the playback with x2 speed. Hit twice to fast-forward the playback to x4 speed. Increment the fast-forwarding speed by increasing your keystrokes. When the fast-forwarding speed is incremented to x16, it auto-restores to x1 speed. <ul style="list-style-type: none"> ▶ This key is only applicable to the Playback screen.
		Rewind	Hit once to rewind with x-1 speed. Hit twice to rewind with x-2 speed. Taper the rewinding speed by increasing your keystrokes. When the rewinding speed is tapered to x-16, it auto-restores to x-1 speed. <ul style="list-style-type: none"> ▶ This key is only applicable to the Playback screen.
		Step Forward	Hit this key once to jump the playback to the next frame.
		Step Backward	Hit this key once to bring the playback to the previous frame.
		Next Interval	Hit this key once to jump the playback to the next interval. <ul style="list-style-type: none"> ▶ See Playback to know how to set Playback Interval.
		Previous Interval	Hit this key once to bring the playback to the previous interval. <ul style="list-style-type: none"> ▶ See Playback to know how to set Playback Interval.
Numeric keypad 		Enters numeric characters, or selects a video channel. Examples: Press key 1 to select video channel 1. Press keys 10+ and 0 to select video channel 10. <ul style="list-style-type: none"> ▶ The timeout for 10+ key is 5 seconds. ▶ Keystroke timeout is applicable to 10+ key only. 	
OS keys	OK / Save key		This key delivers the same function as clicking the OK or Save button on a tab or dialog. Its functions include: <ul style="list-style-type: none"> ▶ Quitting a tab saving the change(s). ▶ Applying the change(s) made on a tab
	Cancel / Exit key		This key delivers the same function as clicking the Exit or Cancel button on a tab or dialog. Its functions include: <ul style="list-style-type: none"> ▶ Quitting a tab without saving the change(s). ▶ Closing a dialog or a tab.
		Enter / Home	<ul style="list-style-type: none"> ▶ As the Enter key, it makes a selection (check box, radio button or a selectable item, i.e. the highlight item) onscreen or confirms input. ▶ As the Home key, it turns the video of the focused channel to the preset Home point. ▶ Hit this key to a selected Video Area to maximize it to full screen. Hit it again to resize the Video Area. See also Video Area and Video Area.
Navigation Keys	Plus (+) and Minus (-) keys		1. Moves between the eight Menus under the Main Menu , i.e. hit these keys to navigate between these menus:  2. Moves between the available tabs featured by a submenu.

		3. Flips up and down the page.
	◀ ▶ Left/Right arrow keys	These keys can be hit to move left and right between the menus of the Main Menu and the highlighted items on all setting pages.
	▲ ▼ Up/Down arrow keys	These keys can be hit to move up and down between the submenus of a menu and the highlighted items on all setting pages.
Live View & Playback Keypad	 Menu	Opens the system's Main Menu . ▶ See Settings to know all the settings featured by the Main Menu . ▶ This key is only applicable to Live View screen.
	 Live View	Switches the screen to Live View .
	 Playback	Switches the screen to Playback and opens the Search dialog.
	 Emergency Record	Enables/disables Always record . ▶ See also Mode tab for more details about the recording modes. ▶ This key is only applicable to the Live View screen.
	 Layout	Switches between different layouts of video channels on the Video Areas . See also Video Area and Video Area .
	 Group	Switches the screen to the next camera group. ▶ This key is only applicable to the Live View screen.
	 Auto Scan	Hit to apply Auto Scan . ▶ See Display for the details about Auto Scan . ▶ Hit again to quit Auto Scan . ▶ Pressing Group , Snapshot , DPTZ , PPTZ , Preset or Go to Preset key will disable Auto Scan . ▶ This key is only applicable to the Live View screen.
	 Audio	Enables/mutes system sound, which is currently unavailable in v1.0.
	 P PTZ	Opens the physical PTZ panel for PTZ operation. ▶ Hit this key again to close the physical PTZ panel. ▶ This key is only applicable to the Live View screen.
	 D PTZ	Opens the digital PTZ panel for PTZ operation. ▶ Hit this key again to close the digital PTZ panel.
	 Preset Set	Opens a panel to set or deletes a preset point. ▶ Only one point can be set or deleted at one time. ▶ The panel auto closes after the setting or deletion is done. Or hit the key once again to close the panel. ▶ This key is only applicable to the Live View screen.
	 Preset Go	Opens a small panel to jump to the desired preset point or to start/stop patrol. ▶ The panel auto closes once the action is launched. Hitting the key once again also closes the panel. ▶ This key is only applicable to the Live View screen.
	 Focus Far	Makes the camera brings the farther subject into focus ▶ This key is only applicable to the Live View screen.
	 Auto Focus	Auto-modifies the focus. ▶ This key is only applicable to the Live View screen.
	 Focus Near	Makes the camera brings the nearer subject into focus ▶ This key is only applicable to the Live View screen.
	 Snapshot	Opens a dialog to capture the current screen. ▶ Press Save button to save the screenshot; or press Cancel

			button to quit without capture.
		Event	Checks the recent events and notifications. ▶ This key is only applicable to the Live View screen.
		I / O	Opens a list of the available camera I/O pins. ▶ This key is only applicable to the Live View screen.
		Auto Setup	Runs auto camera setup. ▶ This key is only applicable to the Live View screen.
		Logout	Logs out of the operating system. ▶ This key is only applicable to the Live View screen.

8 Appendix – RAID System

1. Introduction to RAID

RAID (Redundant Array of Independent Disks) allows multiple disk drives to be combined together into a RAID Volume. You will create a RAID Volume on your unit when you perform the setup procedure.

The benefits of a RAID can include:

- Higher data transfer rates for increased server performance
- Increased overall storage capacity for a single Volume
- Data redundancy/fault tolerance for ensuring continuous system operation in the event of a disk drive failure

Different RAID levels use different organizational models and have varying benefits. The following outline breaks down the properties for each RAID level supported on this unit:

2. RAID 0 – Stripe

When a RAID Volume is striped, the read and write blocks of data are interleaved between the sectors of multiple disk drives. Performance is increased, since the workload is balanced between drives or “members” that form the RAID Volume. Identical drives are recommended for performance as well as data storage efficiency.

The RAID Volume’s data capacity equals the capacity of the smallest disk drive times the number of disk drives. For example, one 100 GB and three 120 GB drives will form a 400 GB (4 x 100 GB) RAID Volume instead of 460 GB.

If disk drives of different capacities are used, there will also be unused

capacity on the larger drives.

Because RAID 0 does not offer Fault Tolerance, meaning that you cannot recover your data after a disk drive failure, we do not recommend a RAID 0 Volume for your unit.

RAID 0 Volumes on this unit consist of one or more disk drives.

3. RAID 1 – Mirror

When a RAID Volume is mirrored, identical data is written to a pair of disk drives, while reads are performed in parallel. The reads are performed using elevator seek and load balancing techniques where the workload is distributed in the most efficient manner. Whichever drive is not busy and is positioned closer to the data will be accessed first.

With RAID 1, if one disk drive fails or has errors, the other mirrored disk drive continues to function. This is called Fault Tolerance. Moreover, if a spare disk drive is present, the spare drive will be used as the replacement drive and data will begin to be mirrored to it from the remaining good drive.

The RAID Volume's data capacity equals the smaller disk drive. For example, a 100 GB disk drive and a 120 GB disk drive have a combined capacity of 100 GB in a mirrored RAID Volume.

If disk drives of different capacities are used, there will also be unused capacity on the larger drive.

RAID 1 Volumes on this unit consist of two disk drives.

If you want a mirrored RAID Volume with more than two disk drives, see **RAID 10 – Mirror / Stripe** for details.

4. RAID 5 – Block Striping with Distributed Parity

RAID 5 organizes block data and parity data across the disk drives. Generally, RAID level 5 tends to exhibit lower random write performance due to the heavy workload of parity recalculation for each I/O. RAID 5 works well for file, database, application and web servers.

The capacity of a RAID 5 Volume equals the smallest disk drive times the number of disk drives, minus one. Hence, a RAID 5 Volume with four 100 GB disk drives will have a capacity of 300 GB. A RAID Volume with two 120 GB disk drives and one 100 GB disk drive will have a capacity of 200 GB.

RAID 5 is generally considered to be the most versatile RAID level.

RAID 5 requires a minimum of three disk drives.

5. RAID 10 – Mirror / Stripe

Mirror/Stripe combines both of the RAID 0 and RAID 1 types. RAID 10 can increase performance by reading and writing data in parallel while protecting data with duplication. At least four disk drives are needed for RAID 10 to be installed. With a four-disk-drive RAID Volume, one drive pair is mirrored together then striped over a second drive pair.

The data capacity RAID 10 Volume equals the capacity of the smallest disk drive times the number of disk drives, divided by two.

In some cases, RAID 10 offers double fault tolerance, depending on which disk drives fail.

RAID 10 Volumes on this unit consist of four disk drives.

Because all of the available disk drives are used for the RAID Volume, you cannot set up a spare drive with RAID 10.

6. Choosing a RAID Level

There are several issues to consider when choosing the RAID level. The following summarizes some advantages, disadvantages and applications for each choice.

- **RAID 0**

Advantage	Disadvantage
<ul style="list-style-type: none">● Implements a striped disk RAID Volume, the data is broken down into blocks and each block is written to a separate disk drive● I/O performance is greatly improved by spreading the I/O	<ul style="list-style-type: none">● Not a true RAID because it is not fault tolerant● The failure of just one drive will result in all data in a RAID Volume being lost

<ul style="list-style-type: none"> load across many channels and drives No parity calculation overhead is involved 	<ul style="list-style-type: none"> Should not be used in mission critical environments
--	---

- RAID 1**

Advantage	Disadvantage
<ul style="list-style-type: none"> Simplest RAID storage subsystem design Can increase read performance by processing data requests in parallel since the same data resides on two different drives 	<ul style="list-style-type: none"> Very high disk overhead - uses only 50% of total capacity

- RAID 5**

Advantage	Disadvantage
<ul style="list-style-type: none"> High Read data transaction rate Medium Write data transaction rate Good aggregate transfer rate Most versatile RAID level 	<ul style="list-style-type: none"> Disk failure has a medium impact on throughput

- RAID 10**

Advantage	Disadvantage
<ul style="list-style-type: none"> Implemented as a mirrored RAID Volume whose segments are RAID 0 RAID Volumes High I/O rates are achieved thanks to multiple stripe segments 	<ul style="list-style-type: none"> Very high disk overhead – uses only 50% of total capacity

9 Appendix – Camera Integration

7. Camera Support List

Any information about camera integration, including camera model and its spec, please refer to NUUO website at www.nuuo.com

Address: B1, No.207-1, Sec. 3, Beixin Rd., Xindian Dist., New Taipei City 231, Taiwan

TEL: +886-2-7739-2260

<http://www.nuuo.com/eHelpdesk.php>