



CE EMC TEST REPORT

FOR

Network Video Recorder

Model:NP-8320,NP-8Bay,NP-8XXX(XXX=160,200,
220,240,320,360,400,420,460,480,600,640)

Trade Name: NUUO

Issued to

NUUO Inc.

10F., No.285, Sec. 2, Wenhua Rd. Banqiao Dist., New Taipei City 220, Taiwan (R.O.C.)

Issued by

Global Certification Corp.

No.146, Sec. 2, Xiangzhang Rd., Xizhi Dist., New Taipei City 221,
Taiwan (R.O.C.)



Note: This test refers exclusively to the test presented test model and sample. This report shall not be reproduced except in full, without the written approval of Global Certification Corporation. This document may be altered or revised by Global Certification Corporation. Personnel only, and shall be noted in the revision section of the document.



TABLE OF CONTENTS	2
1. GENERAL INFORMATION	4
1.1 DESCRIPTION OF THE TESTED SAMPLES	5
1.2 I/O PORT OF THE EUT	5
1.3 TEST METHODOLOGY	5
1.4 DESCRIPTION OF THE SUPPORT EQUIPMENT	6
1.5 FEATURES OF EUT	7
2. INSTRUMENT AND CALIBRATION	8
2.1 MEASURING INSTRUMENT CALIBRATION	8
2.2 TEST AND MEASUREMENT EQUIPMENT	8
2.3 TEST PERFORMED	10
2.4 APPENDIX	10
3. CONDUCTED EMISSION MEASUREMENT	12
3.1 TEST SET-UP	12
3.2 LIMIT	12
3.3 TEST PROCEDURE	12
3.4 TEST SPECIFICATION	13
3.5 TEST DATA	13
3.6 RESULT	13
4. RADIATED EMISSION MEASUREMENT	14
4.1 TEST SETUP	14
4.2 LIMIT	15
4.3 TEST PROCEDURE	15
4.4 TEST SPECIFICATION	15
4.5 TEST DATA	16
4.6 RESULT	16
5. HARMONIC CURRENT EMISSIONS MEASUREMENT	17
5.1 TEST SETUP	17
5.2 LIMIT OF HARMONIC CURRENT	17
5.3 TEST PROCEDURE	17
5.4 TEST SPECIFICATION	17
5.5 TEST DATA	17
5.6 RESULT	17
6. VOLTAGE FLUCTUATIONS	18
6.1 TEST SETUP	18
6.2 VOLTAGE FLUCTUATIONS TEST	18
6.3 TEST PROCEDURE	18
6.4 TEST SPECIFICATION	18
6.5 TEST DATA	18
6.6 RESULT	18
7. ELECTROSTATIC DISCHARGE IMMUNITY TEST (ESD)	19
7.1 TEST SPECIFICATION	19
7.2 TEST SETUP	19
7.3 TEST LEVEL	19
7.4 TEST RESULT	20
8. RADIATED SUSCEPTIBILITY MEASUREMENT (RS)	23
8.1 TEST SETUP	23
8.2 TEST SPECIFICATION	23
8.3 TEST LEVEL	23



8.4	TEST PROCEDURE-----	24
8.5	TEST RESULT -----	24
9.	ELECTRICAL FAST TRANSIENT/BURST (EFT) -----	25
9.1	TEST SETUP -----	25
9.2	TEST SPECIFICATION -----	25
9.3	TEST PROCEDURE-----	25
9.4	TEST LEVEL -----	26
9.5	TEST RESULT -----	26
10.	SURGE -----	27
10.1	TEST SETUP -----	27
10.2	TEST SPECIFICATION -----	27
10.3	TEST LEVEL -----	27
10.4	TEST PROCEDURE-----	28
10.5	TEST RESULT -----	28
11.	IMMUNITY TEST TO CS CONDUCTED DISTURBANCE (CS) -----	29
11.1	TEST SETUP -----	29
11.2	TEST SPECIFICATION -----	29
11.3	TEST LEVEL -----	29
11.4	TEST PROCEDURE-----	30
11.5	TEST RESULT -----	30
12.	POWER FREQUENCY MAGNETIC FIELD (MAGNETIC)-----	31
12.1	TEST SETUP -----	31
12.2	TEST SPECIFICATION -----	31
12.3	TEST LEVEL -----	31
12.4	TEST PROCEDURE-----	31
12.5	TEST RESULT -----	32
13.	VOLTAGE DIPS AND INTERRUPTION MEASUREMENT -----	33
13.1	TEST SETUP -----	33
13.2	TEST SPECIFICATION -----	33
13.3	TEST LEVEL -----	34
13.4	TEST PROCEDURE-----	34
13.5	TEST RESULT -----	35
14.	PERFORMANCE CRITERIA -----	36
15.	EMC MODIFICATION & ESTIMATED MEASUREMENT UNCERTAINTY -----	37
15.1	EMC MODIFICATION -----	37
15.2	ESTIMATED MEASUREMENT UNCERTAINTY -----	37
APPENDIX 1		
PHOTOS OF TEST CONFIGURATION		
APPENDIX 2		
TEST DATA		
APPENDIX 3		
PHOTOS OF EUT		



1. GENERAL INFORMATION

Applicant : NUUO Inc.
Address : 10F., No.285, Sec. 2, Wenhua Rd. Banqiao Dist., New Taipei City 220, Taiwan (R.O.C.)
Manufacturer : Shenzhen Fsan Intelligent Technology Co., Ltd.
Address : Building 2, Bingtangshan Industrial Zone, Shawan, xiavillage,Buji town, Longgangdistrict,Shenzhen, P. R. China
EUT : Network Video Recorder
Model No. : NP-8320,NP-8Bay,NP-8XXX(XXX=160,200,220,240,320,360,400,420,460, 480,600,640)
Trade Name : NUUO
Model : **The major electrical and mechanical constructions of series models are identical to the basic model, except different Software. The model NP-8320, is the testing sample, and the final test data are shown on this test report.**
Differences

Test Standards:

EMI :ClassA

EN55022: 2010

EN61000-3-2:2006+A1:2009+A2:2009

EN61000-3-3:2013

EMS :

EN55024:2010

EN61000-4-2 : 2009

EN61000-4-3 : 2006+A2:2010

EN61000-4-4 : 2012

EN61000-4-5 : 2006

EN61000-4-6 : 2014

EN61000-4-8 : 2010

EN61000-4-11 : 2004

According to the applicant's declaration this EUT is a Class A product, and to be marketed in industrial environment only.

The above equipment was tested by Global Certification Corp. For compliance with the requirements set forth in the EUROPEAN COUNCIL Directive 2014/30/EU and the technical standards mentioned above. The results of testing in this report apply only to the product/system, which was tested.

The test was carried out on Jul. 29, 2016 and this test report shall not be reproducing in part without written approval of Global Certification Corp.

Tested By:

Approved by:

Aug. 05, 2016
Date

Bob Yao, Engineer

Aug. 05, 2016
Date

Adam Chou, Manager



1.1 DESCRIPTION OF THE TESTED SAMPLES

EUT

EUT Type : Normal Type Engineering Type

EUT Name : Network Video Recorder

Model No. : NP-8320

EUT Power Rating : AC Power : 230VAC, 50Hz

DC Power

DCV from PC

DCV from Adaptor

The frequency of the EUT

Highest Operating Frequency : 1.6GHz

EUT Received Date : Jul. 01, 2016

EMC Test Completed Date : Jul. 29, 2016

1.2 I/O PORT OF THE EUT

I/O port type	Q'ty	Tested with
HDMI Port	1	1
VGA Port	1	1
USB3.0 Port	1	1
USB2.0 Port	3	3
e-SATA Port	1	1
LAN Port	2	2
Audio IN Port	1	1
Audio OUT Port	1	1
Alarm Port	2	2

1.3 TEST METHODOLOGY

1.3.1 EUT SYSTEM OPERATION

1. The EUT was configured according to EN55022 Class A
2. All I/O ports are connected to the appropriate peripherals.
3. Photos of test configuration please refer to appendix 1.
4. Perform the EMC testing procedures, and measure the maximum emission noise.
5. The combined texts of the International Standard CISPR 22:2008 with agreed common modifications were approved by CENELEC as EN 55022:2010
6. As required in 7.1.1 of EN 55022:2010: A CISPR limit is a limit which is recommended to national authorities for incorporation in national publications, relevant legal regulations and official specifications. It is also recommended that international organizations use



these limits. The test data attached for this EUT is subject to CISPR limit.

- 7. EUT Operating Mode: A Full screen consisting of repeated “H” patterns should be continuously scrolled down under EMCTEST.

1.3.2 DECISION OF FINAL TEST MODE

Mode 1: Recorder ; LAN 100M

1.4 DESCRIPTION OF THE SUPPORT EQUIPMENT

Setup Diagram

See test photographs attached in appendix 1 for the actual connections between EUT and support equipment.

Support Equipment

Peripherals Devices:

OUTSIDE SUPPORT EQUIPMENT							
No.	Equipment	Model	Serial No.	FCC ID/ BSMI ID	Trade name	Data Cable	Power Cord
1.	POE Hub	POI-3004	14033100035	N/A	Gigabit	N/A	1.8m
2.	POE Hub	POE-151	AF001023005 14(000)	N/A	PLANT	N/A	0.7m
3	LAN Hub	DI-604	DYIU2810022 48	N/A	D-Link	N/A	1.5m
4	3.5”HDD1	OF 12115 MNR5C00C18	F328X8ND	N/A	HITACHI	N/A	N/A
5	3.5”HDD2	OF 12115 MNR5C00C188	F328GLUD	N/A	HITACHI	N/A	N/A
6	3.5”HDD3	OF 12115 MNR5C00C18	F328T4ZD	N/A	HITACHI	N/A	N/A
7	3.5”HDD4	OF 12115 MNR5C00C18	F328J32D	N/A	HITACHI	N/A	N/A
8	3.5”HDD5	OF 12115 MNR5C00C18	F328L6XD	N/A	HITACHI	N/A	N/A
9	3.5”HDD6	OF 12115 MNR5C00C18	F328SGZD	N/A	HITACHI	N/A	N/A
10	3.5”HDD7	OF 12115 MNR5C00C18	F328LPAD	N/A	HITACHI	N/A	N/A
11	3.5”HDD8	OF 12115 MNR5C00C18	F328L7JD	N/A	HITACHI	N/A	N/A
12	IP Camera	E23	N/A	N/A	ACTi	N/A	N/A
13	IP Camera	E210	N/A	N/A	ACTi	N/A	N/A
14	NB	Compaq Presario V3000	2CE7202SLC	R33001	HP	Unshielded 15m	Unshielded 1.8m
15	MONITOR (HDMI)	EM-24VT08D	366603009	R41A01	SAMPO	Shielded 1.6m	UnShielded 1.8m
16	MONITOR (VGA)	ST2220Lb	CN-OHXG8 5-74261-223 -043L	R43002	DELL	Shielded 1.8m	UnShielded 1.8m



17	USB3.0 Flash	N/A	N/A	D33193	TRANSC END	N/A	N/A
18	USB Flash	D33193 N14939	701178 2482	D33193	TRANSC END	N/A	N/A
19	KEY BOARD	1576	0066904835 022	R31264	Microsoft	Unshielded 1.2m / USB	N/A
20	EAR PHONE	E220	N/A	N/A	DeeJay	Unshielded 2m	N/A
21	Mouse	N/A	N/A	N/A	NUUO	1.1m	N/A
22	e-SATA 3.5” HDD	N/A	N/A	N/A	N/A	1.8m	N/A
EUT ACCESSORIES/COMPONENTS							
No.	Equipment	Model	Serial No.	FCC ID/ BSMI ID	Trade name	Data Cable	Power Cord
1.	PCB(Main board)	HI3536_10HD D NVR	N/A	N/A	N/A	N/A	N/A
2.	PCB-1	V06/V04 FRO NT-USB x2	N/A	N/A	N/A	N/A	N/A
3	Switching Power Supply	FSP200-50GSV -5K.	N/A	E190414	FSP GROUP INC.	N/A	N/A
4	FAN	N/A	N/A	N/A	XING XIN	N/A	N/A

Note: All the above equipment/cable were placed in worse case position to maximize emission signals during emission test.

Grounding: Grounding was in accordance with the manufacturer’s requirement and conditions for the intended use.

1.5 FEATURES OF EUT

Please refer to user manual or product specification.



2. INSTRUMENT AND CALIBRATION

2.1 MEASURING INSTRUMENT CALIBRATION

The measuring equipment utilized to perform the tests documented in the report has been calibrated once a year or in accordance with the manufacturer's recommendations, and is traceable to recognized national standards.

2.2 TEST AND MEASUREMENT EQUIPMENT

The following list contains measurement equipment used for testing. The equipment conforms to the requirement of CISPR 16-1-1, CISPR16-1-4, CISPR 16-2-3 and other required standards.

Calibration of all test and measurement, including any accessories that may effect such calibration, is checked frequently to ensure the accuracy. Adjustments are made and correction factors are applied in accordance with the instructions contained in the respective.

TABLE 1 LIST OF TEST AND MEASUREMENT EQUIPMENT

Conducted Emission Measurement (Test Site ID: GCC_CE-01)					
Instrument	Manufacturer	Model No.	Serial No.	Calibration Due Date	Note
EMC Test Receiver	R&S	ESCI	100438	Dec. 16, 2016	
LISN #1	SCHWARZBECK	NNLK8121	550213	Dec. 15, 2016	For EUT
LISN #2	EMCO	3825/2	9001-1400	N/A	For Support Unit
RF Cable	Huber+Suhner	RG223/U	Cable-001	Dec.17, 2017	
Impedance Stabilization	Teseq GmbH	ISNT800	23334	Sep. 19, 2016	
Absorbing Clamp	COM-POWER	AB-050	421915	Oct. 27,2016	
RF Cable	Huber+Suhner	5D-FB	CABLE-007	Oct. 29,2016	
Test Software	AUDIX	E3	6.2008-10-2C	N/A	
3m/10m Open Area Test Site Radiated Emission Measurement (Test Site ID: GCC_RE-01)					
Instrument	Manufacturer	Model No.	Serial No.	Calibration Due Date	Note
Bilog Antenna	SUNOL	JB1	A052104	Feb. 21, 2017	
EMC Test Receiver	LIG	ISA-80	L0809K001	Feb.22, 2017	
RF Cable	JYE BAO	RG214/U	Cable-002	Nov. 19, 2016	
Pre-Amplifier	WIRELESS	FPA-6592G	60021	Nov. 11, 2016	
Test Software	AUDIX	E3	6.2009-5-7a(n)gcc	N/A	
966_3m EMC Chamber Radiated Emission Measurement (Test Site ID: GCC_RE-02 and GCC_RE-02G)					
Instrument	Manufacturer	Model No.	Serial No.	Calibration Due Date	Note
EMC Test Receiver	LIG	ER-265	L0907B006	Jul. 08, 2017	
Bilog Antenna	SUNOL	JB1	A052204	Nov. 26, 2017	



Pre-Amplifier	WIRELESS	FPA-6592G	60028	Sep. 29, 2016	
RF Cable_NSA_Rx	HUBER + UHNER	RG213/U	Cable-004	Jul. 27, 2017	
Double Ridged Guide Horn Antenna	EST.LINDGREN	3117	00119028	Oct.01, 2016	
Microwave Cable	HUBER SUHNER	SUCOFLEX	Cable-003-4M	Jan. 26, 2017	
Microwave Cable	HUBER SUHNER	SUCOFLEX	Cable-003-3M	Jan. 26, 2017	
Microwave Preamplifier	EMCINSTRUMENT	EMC051845	980059	Mar. 23, 2017	
Test Software	AUDIX	E3	6.101222	N/A	
Power Harmonic and Voltage Fluctuations Measurement (Test Site ID: GCC_HF-01)					
Instrument	Manufacturer	Model No.	Serial No.	Calibration Due Date	Note
5KV AC Power Source	SCHAFFNER	NSG1007	55869	Jul. 03, 2017	
Signal Conditioning	SCHAFFNER	CCN1000-1	72281	Jul. 03, 2017	
EMS					
Instrument	Manufacturer	Model No.	Serial No.	Calibration Due Date	Note
EN61000-4-2 (Test Site ID: GCC_EMS-01)					
ESD Generator	TESEQ	NSG437	313	Aug.25, 2016	
EN61000-4-3 (Test Site ID: GCC_EMS-02)					
RF Power Meter	BOONTON	4231A	110602	Jun. 17, 2017	
Signal Generator	R&S	SM300	101722	Jun. 16, 2017	
Electric Field probe	ETS-LINDGREN	HI-6005	29837	N/A	
Power Amplifier	SCHAFFNER	CBA9413B	4039	Jun. 16, 2017	
Power Amplifier	TESEQ	CBA3G-050	T43752	Jun. 16, 2017	
Switch Network	TESEQ	RFB2000	26336	N/A	
RF Power sensor	BOONTON	51011-EMC	33109	Jun. 17, 2017	
EN61000-4-4/ EN61000-4-5/ EN61000-4-8/ EN61000-4-11 (Test Site ID: GCC_EMS-03)					
EMC Immunity Test system	EMC PARTNERAG	TRA200IN6	739	May. 13, 2017	
Conducted disturbances generator	FRANKONIA	CIT10/75	102D3233	Sep. 01, 2016	
Induction Coil Interface	SCHAFFNER	2141	6019	Jul. 01, 2017	
TTIAXIAL ELF Magnetic Field Meter	SYPRIS	4090	4090070316	Nov. 20, 2016	
ANTENNA	EMC PARTNER AG	MF1000	117	Jul. 06, 2017	
EN61000-4-6 (Test Site ID: GCC_EMS-04)					
CDN	SCHAFFNER	CDN M316	20653	Oct. 07, 2016	
CDN	SCHAFFNER	CDN M216	19286	Jun. 17, 2017	
CDN	FRANKONIA	RJ45	60050134	Sep. 09, 2016	



6dB Attenuator	FRANKONIA	75-A-FFN-06	102D3233	Jun. 24, 2017	
EM Injection Clamp	FCC	F-203I-23MM	471	Sep. 10, 2016	
Conducted disturbances generator	FRANKONIA	CIT10/75	102D3233	Jun. 23, 2017	

※ Calibration interval of instruments listed above is one year

2.3 TEST PERFORMED

Conducted emissions were investigated over the frequency range from 0.15MHz to 30MHz using a receiver which resolution bandwidth is set at 9 KHz.

Radiated emissions were investigated over the frequency range from 30MHz to 1000MHz using a receiver which resolution bandwidth is set at 120KHz. Radiated measurement was performed at distance that from an antenna to EUT is 10meters.

2.4 APPENDIX

Appendix A: Measurement Procedure for Main Power Port Conducted Emissions

The measurements are performed in a Globallab's room; The EUT was placed on non-conductive 1.0m x 1.5m table, which is 0.8 meter above an earth-grounded.

Power to the EUT was provided through the LISN which has the Impedance (50ohm/50uH) vs. Frequency Characteristic in accordance with the standard. Power to the LISNs was filtered to eliminate ambient signal interference and these filters were bonded to the ground plane. Peripheral equipment required to provide a functional system (support equipment) for EUT testing was powered from the second LISN through a ganged, metal power outlet box which is bonded to the ground plane at the LISN.

If the EUT is supplied with a flexible power cord, the power cord length in excess of the distance separating the EUT from the LISN shall be folded back and forth at the center of the lead so as to form a bundle not exceeding 40cm in length. If the EUT is provided with a permanently coiled power cord, bundling of the cord is not required. If the EUT is supplied without a power cord, the EUT shall be connected to the LISN by a power cord of the type specified by the manufacturer which shall not be longer than 1 meter. The excess power cord shall be bundled as described above. If a non-flexible power cord is provided with the EUT, it shall be cut to the length necessary to attach the EUT to the LISN and shall not be bundled.

The interconnecting cables were arranged and moved to get the maximum measurement. Both the line of power cord and hot and neutral, was measured.

The highest emissions were analyzed in details by operating the spectrum analyzer in fixed tuned mode to determine the nature of the emissions and to provide information which could be useful in reducing their amplitude.

Appendix B: Test Procedure for Radiated Emissions

Preliminary Measurements in the Anechoic Chamber

The radiated emissions are initially measured in the anechoic chamber at a measurement distance of 3 meters. Desktop EUT are placed on a wooden stand 0.8 meter in height. The



measurement antenna is 3 meters from the EUT. The test setup in anechoic chamber is the same as open site. The turntable rotated 360°. The antenna height is 1 meter. The primary objective of the radiated measurements in the anechoic chamber is to identify the frequency spectrum in the absence of the electromagnetic environment existing on the open test site. The frequencies can then be pre-selected on the open test site to obtain the corresponding amplitude. The initial scan is made with the spectrum analyzer in automatic sweep mode. The spectrum peaks are then measured manually to determine the exact frequencies.

Measurements on the Open Site or Chamber

The radiated emissions test will then be repeated on the open site or chamber to measure the amplitudes accurately and without the multiple reflections existing in the shielded room. The EUT and support equipments are set up on the turntable. Desktop EUT are set up on a wooden stand 0.8 meter above the ground.

For the initial measurements, the receiving antenna is varied from 1 to 4 meter height and is changed in the vertical plane from vertical to horizontal polarization at each frequency. Both reading are recorded with the quasi-peak detector with 120 KHz bandwidth. For frequency between 30 MHz and 1000MHz, the reading is recorded with peak detector or quasi-peak detector. For the frequency range is above 1 GHz, the EUT was positioned such that distance from antenna to the EUT is 3 meters. The bandwidth set on the field strength is 1 MHz when the frequency range is above 1GHz.

At the highest amplitudes observed, the EUT is rotated in the horizontal plane while changing the antenna polarization in the vertical plane to maximize the reading. The interconnecting cables were arranged and moved to get the maximum measurement. Once the maximum reading is obtained, the antenna elevation and polarization will be varied between specified limits to maximize the readings.

3. CONDUCTED EMISSION MEASUREMENT

3.1 TEST SETUP

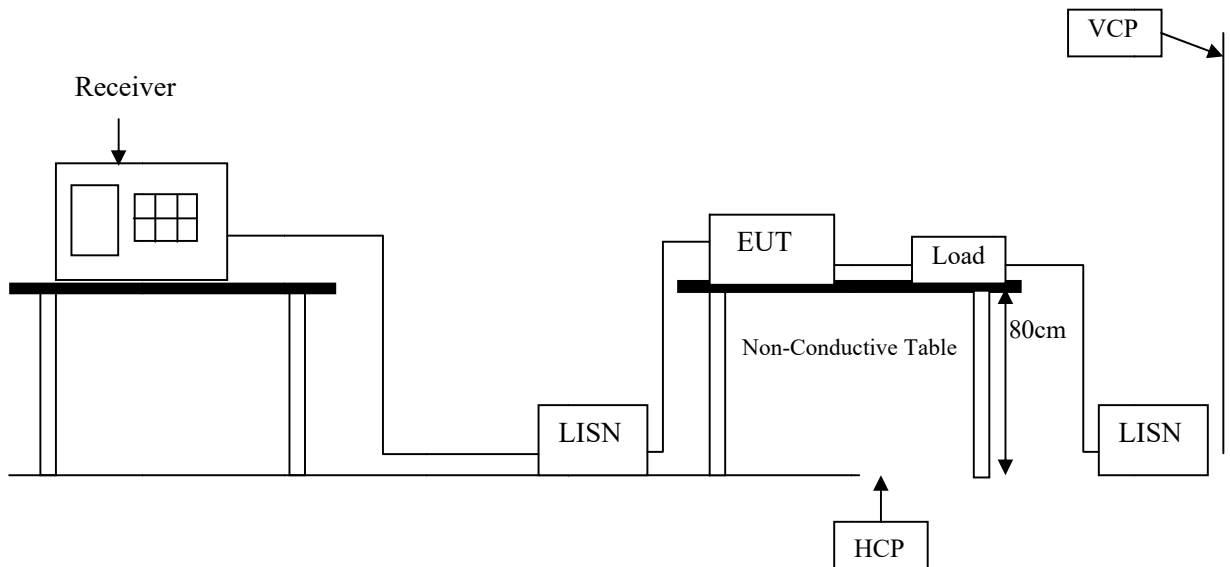

3.2 LIMIT

Frequency range (MHz)	CLASS A		CLASS B		Receiver RBW
	QP dB(uV)	Average dB(uV)	QP dB(uV)	Average dB(uV)	
0.15-0.5	79 dBuV	66 dBuV	66 - 56 dBuV	56 - 46 dBuV	9KHz
0.5-5.0	73 dBuV	60 dBuV	56 dBuV	46 dBuV	9KHz
5.0-30.0	73 dBuV	60 dBuV	60 dBuV	50 dBuV	9KHz

Remark: In the above table, the tighter limit applies at the band edges.

3.3 TEST PROCEDURE

The EUT and simulators are connected to the main power through a line impedance stabilization network (LISN). It provides a 50 ohm / 50 μ H coupling impedance for the measuring equipment. The peripheral devices are also connected to the main power through a LISN that provides a 50 ohm / 50 μ H coupling impedance with 50 ohm termination. (Please refer to the block diagram of the test setup and photograph.)

Both sides of AC line are checked for the maximum conducted emission interference. In order to find the maximum emissions, the relating positions of equipment and all of the interference cables must be changed according to EN55022 regulations: The measurement procedure on conducted emission interference.

The resolution bandwidth of the field strength meter is set at 9 KHz.



3.4 TEST SPECIFICATION

According to EN55022 Class A

(Please refer to Page 4 for dated references which are related to the standard as mentioned above)

3.5 TEST DATA:

Please refer to appendix 2.

3.6 RESULT: PASS

3.7 LIMIT OF CONDUCTED COMMON MODE DISTURBANCE AT TELECOMMUNICATION PORTS:

Frequency Range MHz	Class A		Class B		Receiver RBW
	Quasi Peak (dBuV)	Average	Quasi Peak (dBuV)	Average	
0.15 ~ 0.5	97 - 87	84 - 74	84 - 74	74 - 64	9KHz
0.5 ~ 30	87	74	74	64	9KHz

The limits decrease linearly with the logarithm of the frequency in the range 0.15 MHz to 0.5MHz for Class A.

Remark:

1. Measuring mode: ①LAN1 100Mbps, ②LAN1 10Mbps ③LAN2 100 Mbps
2. The Worst Mode: ③ LAN2 100 Mbps
3. Deviations from the test standards and rules: None.
4. “*”, means this data is peak measuring as peak value is under Q.P. Limit or Average Limit 3dB margin.

3.8 RESULT OF CONDUCTED COMMON MODE DISTURBANCE AT TELECOMMUNICATION PORTS

Please refer to appendix 2.

4. RADIATED EMISSION MEASUREMENT

4.1 TEST SETUP

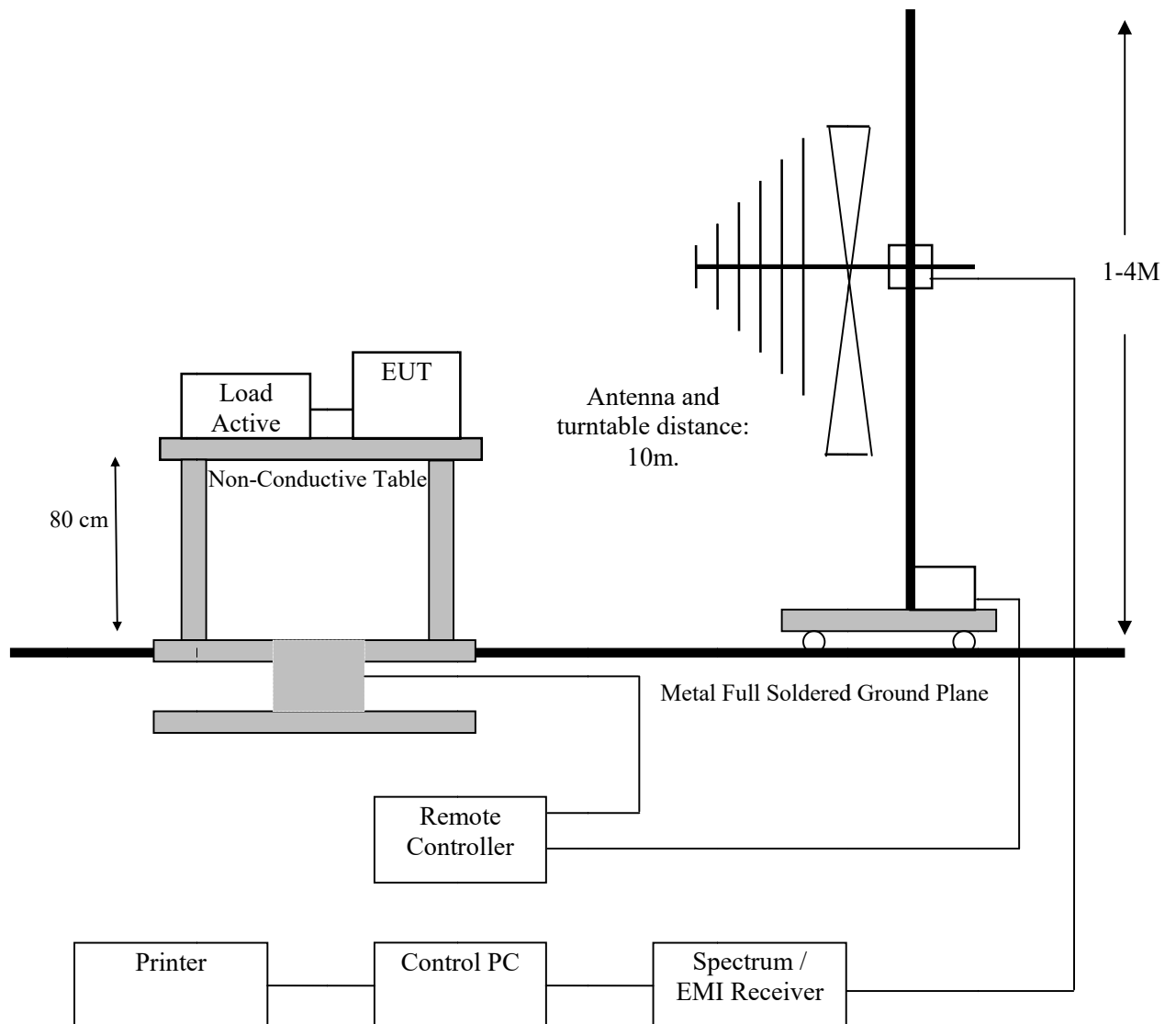



4.2 LIMIT

Frequency MHz	Class A		Class B		Receiver RBW
	Distance (Meter)	Limit dB μ V/m	Distance (Meter)	Limit dB μ V/m	
30 ~ 230	10	40	10	30	120KHz
230 ~ 1000	10	47	10	37	120KHz

For Class A

Frequency range GHz	Average limit dB(μ V/m)	Peak limit dB(μ V/m)	Receiver RBW
1 to 3	56	76	1MHz
3 to 6	60	80	1MHz
NOTE The lower limit applies at the transition frequency.			

For Class B

Frequency range GHz	Average limit dB(μ V/m)	Peak limit dB(μ V/m)	Receiver RBW
1 to 3	50	70	1MHz
3 to 6	54	74	1MHz
NOTE The lower limit applies at the transition frequency.			

Remark: In the above table, the tighter limit applies at the band edges

4.3 TEST PROCEDURE

The EUT and its simulators are placed on turn table, non-conductive and wooden table, which is 0.8 meter above ground. The turn table rotates 360 degrees to determine the position of the maximum emission level. The EUT was positioned such that distance from antenna to the EUT is 10 meters. For the frequency range is above 1 GHz, the EUT was positioned such that distance from antenna to the EUT is 3 meters.

The antenna is moved up and down between 1 meter and 4 meters to receive the maximum emission level.

Both horizontal and vertical polarizations of the antenna are set on measurement. In order to find the maximum emission, all of the interference cables must be manipulated according to EN55022 regulations: the test procedure of the radiated emission measurement.

The bandwidth set on the field strength is 120 KHz when the frequency range is below 1GHz. The bandwidth set on the field strength is 1 MHz when the frequency range is above 1GHz.

4.4 TEST SPECIFICATION

According to EN55022 Class A



(Please refer to Page 4 for dated references which are related to the standard as mentioned above)

4.5 TEST DATA:

Please refer to appendix 2.

4.6 RESULT: PASS



5. HARMONIC CURRENT EMISSIONS MEASUREMENT

5.1 TEST SETUP

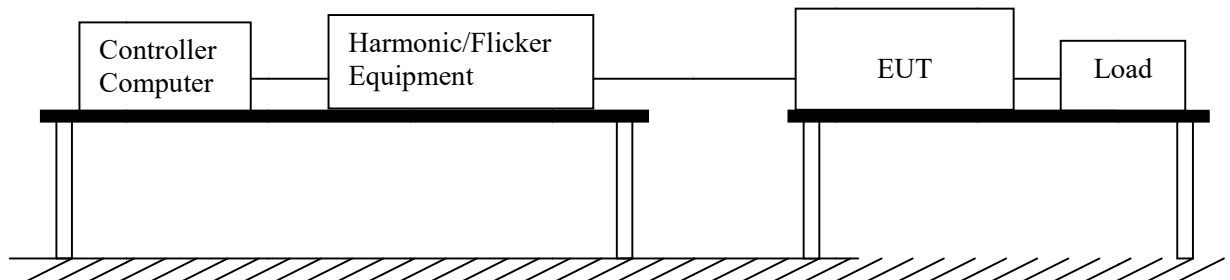

5.2 LIMIT OF HARMONIC CURRENT

Limit of Harmonic Currents

Harmonic Order	Maximum Permissible Harmonic Current (Ampere)	Harmonic Order	Maximum Permissible Harmonic Current (Ampere)
Odd Harmonic		Even Harmonic	
3	2.30	2	1.08
5	1.14	4	0.43
7	0.77	6	0.30
9	0.40	8 ≤ n ≤ 40	0.23 x 8/n
11	0.33		
13	0.21		
15 ≤ n ≤ 39	0.15 x 15/n		

5.3 TEST PROCEDURE

The EUT is supplied in series with power analyzer from a power source has the same normal voltage and frequency as the rated supply voltage and the equipment under test.

5.4 TEST SPECIFICATION

According to EN61000-3-2

(Please refer to Page 4 for dated references which are related to the standard as mentioned above)

5.5 TEST DATA:

Please refer to appendix 2.

5.6 RESULT:

PASS

6. VOLTAGE FLUCTUATIONS

6.1 TEST SETUP

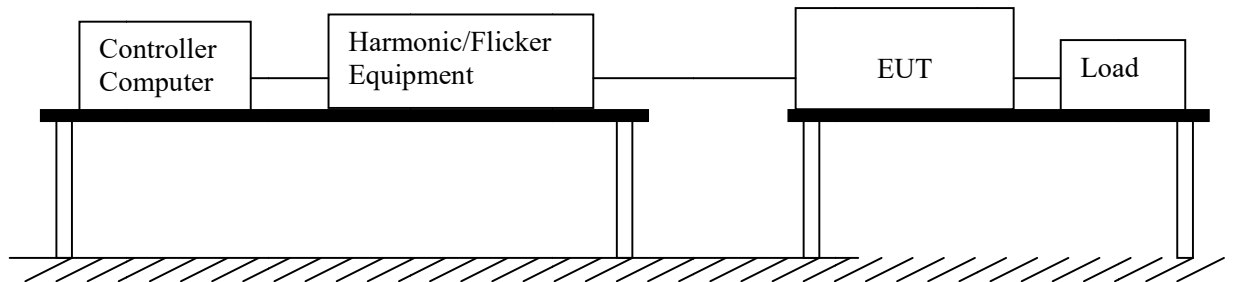

6.2 VOLTAGE FLUCTUATIONS TEST

Port:	AC mains
Basic Standard:	EN61000-3-3
Test Procedure	Refer to paragraph 6.3
Observation period:	For Pst 10min
	For Plt 2 hours

6.3 TEST PROCEDURE

The EUT is supplied in series with reference impedance from a power source with the voltage and frequency as the nominal supply voltage and frequency of the EUT.

6.4 TEST SPECIFICATION

EN61000-3-3

(Please refer to Page 4 for dated references which are related to the standard as mentioned above)

6.5 TEST DATA:

Please refer to appendix 2.

6.6 RESULT:

PASS

7. ELECTROSTATIC DISCHARGE IMMUNITY TEST (ESD)

7.1 TEST SPECIFICATION

Test is carried out according to EN61000-4-2, and the Test Level is subject to Table 1 of EN 55024.(Please refer to Page 4 for dated references which are related to the standard as mentioned above)

7.2 TEST SETUP

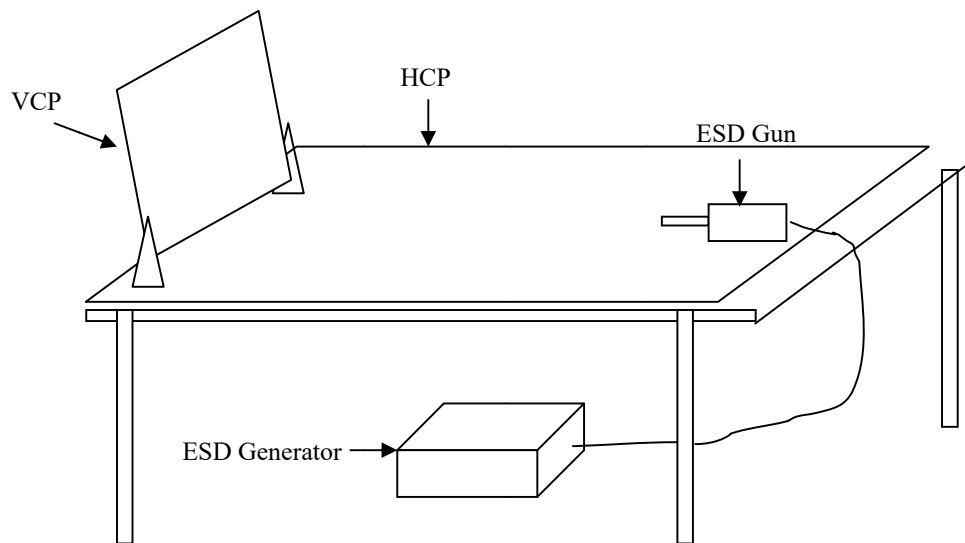

7.3 TEST LEVEL

Item	Test Specification	Unit	Performance Criteria
Enclosure Room	±2, 4, 8 (Air Discharge)	KV (Charge Voltage)	B
Electrostatic Discharge	±2,4 (Contact Discharge)		
Time between test	<u>1</u>	sec	

Number of test: 10 Discharges / Test point / Polarity / Level

Particular requirements: at least 200 discharges, 100 each at negative and positive polarity, at a minimum of four test points.

When the measurement was taken, The ESD discharger was performed in single discharge. For the single discharge time between successive single discharges will keep on one second. It was at least ten single discharges with positive and negative at the same selected pointed. The selected pointed, which was performed with electrostatic discharge, was marked on the red label on the EUT

Indirect applicant of discharge to the EUT

Vertical Coupling Plane (VCP)



The coupling plane, of dimensions 0.5m x 0.5m, is placed parallel to, and positioned at a distance 0.1m from, the EUT, with the discharge electrode touching the coupling plane.

The four faces of the EUT will be performed with electrostatic discharge. It was at least ten singles discharges with positive and negative at the same selected point.

Horizontal Coupling Plane (HCP)

The coupling plane is placed under the EUT. The generator shall be positioned vertically at a distance of 0.1m from the EUT, with the discharge electrode touching the coupling.

The four faces of the EUT will be performed with electrostatic discharge. It was at least ten single discharges with positive and negative at the same selected pointed.

7.4 TEST RESULT

Model: NP-8320

Temperature: 24°C , Humidity: 46 % RH

Test Point	Air Discharge	Contact Discharge	Performance Criteria	Result
HCP	----	±2, 4KV	A	PASS
VCP	----	±2, 4KV	A	PASS
CASE	----	±2, 4KV	A	PASS
Screw		±2, 4KV	A	PASS
USB2.0	±2, 4, 8KV	----	A	PASS
USB3.0	±2, 4, 8KV	----	A	PASS
HDMI	±2, 4, 8KV	----	A	PASS
VGA	±2, 4, 8KV	----	A	PASS
LAN1	±2, 4, 8KV	----	A	PASS
LAN2	±2, 4, 8KV	----	A	PASS
Audio-In	±2, 4, 8KV	----	A	PASS
Audio Out	±2, 4, 8KV	----	A	PASS
e-SATA	±2, 4, 8KV	----	A	PASS
Alarm IO	±2, 4, 8KV	----	A	PASS
Case	±2, 4, 8KV	----	A	PASS
Power button	±2, 4, 8KV	----	A	PASS
Reset button	±2, 4, 8KV	----	A	PASS
Power LED	±2, 4, 8KV	----	A	PASS
Ethernet LED	±2, 4, 8KV	----	A	PASS
Power SW	±2, 4, 8KV	----	A	PASS
Power connector	±2, 4, 8KV	----	A	PASS

Test Points please see arrows of below photo.



Red Dot: Contact / Blue Dot: Air

Test Points please see arrows of below photo.



Red Dot: Contact / Blue Dot: Air

Test Points please see arrows of below photo.



Red Dot: Contact / Blue Dot: Air

Test Points please see arrows of below photo.



Red Dot: Contact / Blue Dot: Air

Final Result:**PASS**

Remark:

Photos of test configuration please refer to appendix 1.

8. RADIATED SUSCEPTIBILITY MEASUREMENT (RS)

8.1 TEST SETUP

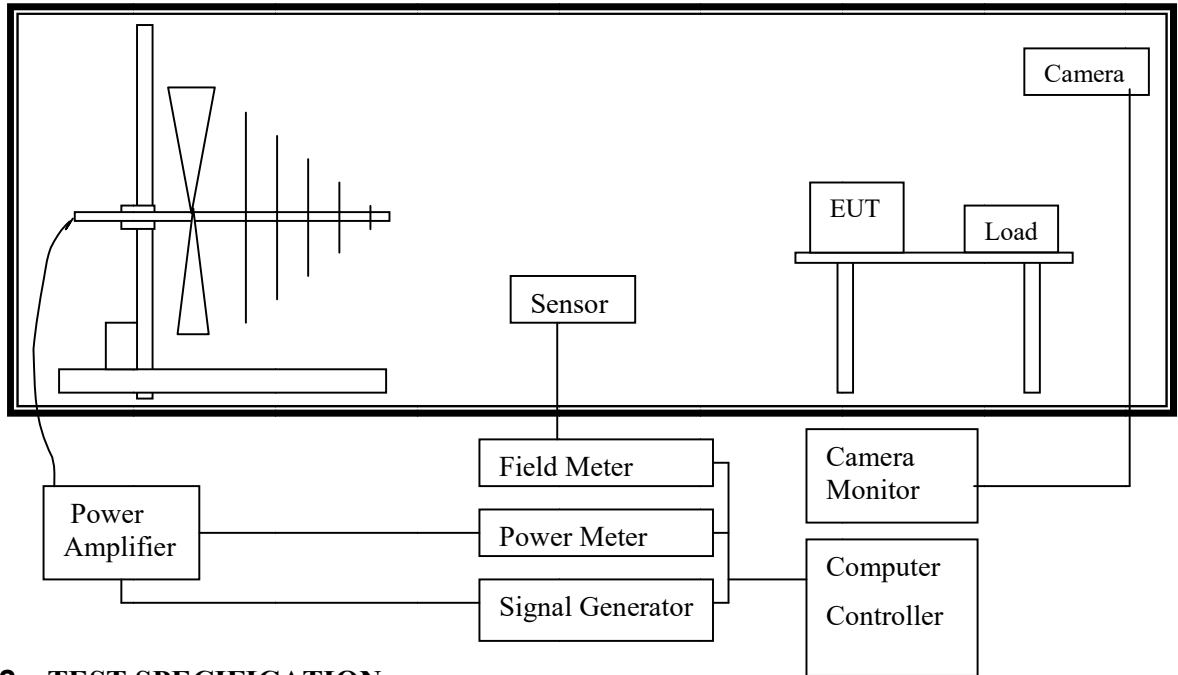

8.2 TEST SPECIFICATION

Test is carried out according to EN61000-4-3, and the Test Level is subject to Table 1 of EN 55024. (Please refer to Page 4 for dated references which are related to the standard as mentioned above)

8.3 TEST LEVEL

Item	Test Specification	Unit	Performance Criteria
Radio –Frequency	80~1000	MHz	A
Electromagnetic Field	3	V/m (unmodulated, rms)	
Amplitude Modulated	80	%AM (1KHz)	



8.4 TEST PROCEDURE

The EUT and load, which are placed on a wooden table whose height is 0.8 meter aboveground, are placed with one coincident with the calibration plane such that the distance from antenna to the EUT is 3 meters.

Both horizontal and vertical polarization of the antenna position and four sides of the EUT are set on measurement. In order to judge the EUT performance, a CCD camera is used to monitor the situation of EUT.

All the scanning conditions are as follows:

Condition of Test	Remarks
1. Field Strength	3V/m; Level 2
2. Radiated Signal	AM 80% modulated with 1KHz
3. Scanning Frequencies	80MHz ~ 1000MHz
4. Dwell Time	3 seconds
5. Frequency step size	1%
6. The rate of swept of frequency	1.5×10^{-3} decades/s
7. Antenna Polarity	HORIZONTAL & VERTICAL
8. The four sides of EUT are tested	FRONT, REAR, RIGHT, LEFT

8.5 TEST RESULT

Model: NP-8320

Temperature: 24°C , Humidity: 46 % RH

ANT SIDE	3V HORIZONTAL	3V VERTICAL	RESULT
FRONT	A	A	PASS
REAR	A	A	PASS
RIGHT	A	A	PASS
LEFT	A	A	PASS

Note: A means criteria A.

Final Result:**PASS**

Remark:

Photos of test configuration please refer to appendix 1.

9. ELECTRICAL FAST TRANSIENT/BURST (EFT)

9.1 TEST SETUP

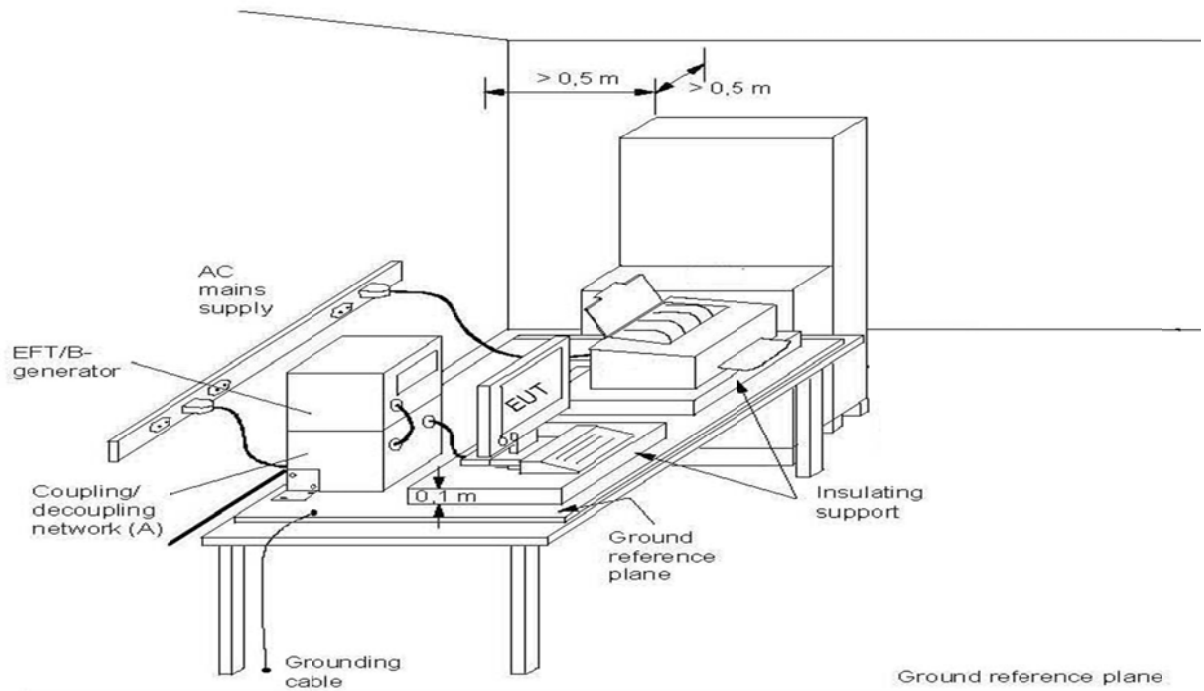

9.2 TEST SPECIFICATION

Test is carried out according to EN61000-4-4, and the Test Level is subject to Table 1 of EN 55024 (Please refer to Page 4 for dated references which are related to the standard as mentioned above)

9.3 TEST PROCEDURE

The EUT and load are placed on a ground reference plane and insulated from it by an insulating support $0,1 \text{ m} \pm 0,01 \text{ m}$ thick. The minimum area of the ground reference plane is $1 \text{ m} \times 1 \text{ m}$. It also projected beyond the EUT by at least 0.1meter on all sides.

For Input and Output AC power or DC Input and DC Output Power Ports:

The EUT is connected with the power mains through a coupling device that directly couples the EFT interference signal.

Each of the line and nature conductors is impressed with burst noise for 1 minute.

For Protective Earth Port:

The EUT is connected to the power mains through a coupling device that directly couples the EFT interference signal. The protective earth line (PE) is impressed with burst noise for 1 minute.

The length of power cord between the coupling device and the EUT shall be $0.5 \text{ m} \pm 0.05 \text{ m}$.

For signal Lines and Control Lines Test:

The EFT interference signal is through a coupling clamp device couples to the signal and control lines of the EUT with burst noise for 1 minute.



9.4 TEST LEVEL

Item	Test Specification		Unit	Performance Criteria
Test Voltage	AC Input Power Line	±0.5, ±1	KV (Peak)	B
	DC Input Power Line	±0.5		
	Signal & Telecommunication Port	±0.25, ±0.5		
Pulse Rise time & Duration	5/50		Tr/Ts (ns)	
Pulse Repetition	5		Rep. Frequency (KHz)	
Coupling of power line	L, N, PE, L+N, L+PE, N+PE, L+N+PE			

9.5 TEST RESULT

Model: NP-8320

Temperature: 24°C , Humidity: 46 % RH

Power Line							
TEST VOLTAGE	L	N	PE	L+N	L+PE	N+PE	L+N+PE
±1KV	A	A	A	A	A	A	A

Note: A means criteria A.

Signal Control Line	
TEST VOLTAGE	Performance Criteria
±0.5KV	A

Note: A means criteria A.

Final Result:**PASS**

Remark:

Photos of test configuration please refer to appendix 1.

10. SURGE

10.1 TEST SETUP

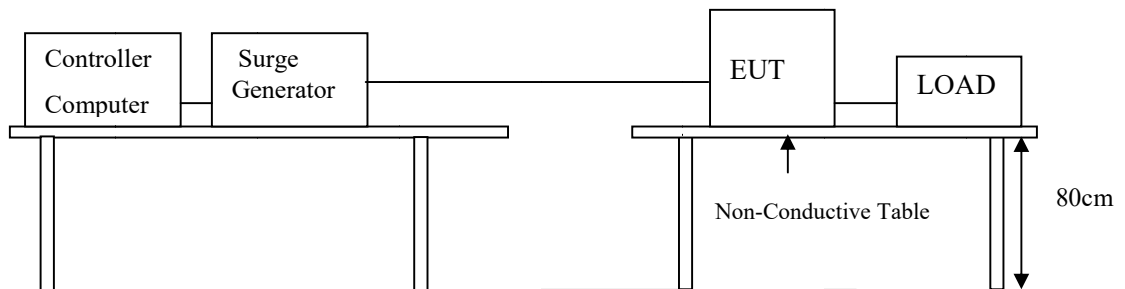

10.2 TEST SPECIFICATION

Test is carried out according to EN61000-4-5, and the Test Level is subject to Table 1 of EN 55024 (Please refer to Page 4 for dated references which are related to the standard as mentioned above)

10.3 TEST LEVEL

Item	Test Specification	Unit	Performance Criteria
DC Input and DC Output Power Ports			
Surge	1.2/50(8/20)	Tr/Ts (μs)	B
Line to Ground	±0.5	KV	
Line to Line	±0.5	KV	
Polarity	POSITIVE / NEGATIVE		

Item	Test Specification	Unit	Performance Criteria
AC Input and AC Output Power Ports			
Surge	1.2/50(8/20)	Tr/Ts (μs)	B
Line to Ground	±2	KV	
Line to Line	±1	KV	
Polarity	POSITIVE / NEGATIVE		
Phase shifting in a range between 0° to 360°			



Item	Test Specification	Unit	Performance Criteria
Signal & Telecommunication Port			
Surge	10/700	Tr/Ts (µs)	C
Line to Ground	±1	KV	
Line to Ground	±4	KV	
Polarity	POSITIVE / NEGATIVE		
For ports where primary protection is intended, surges are applied at voltages up to 4kV with the primary protectors fitted. Otherwise the 1kV test level is applied without primary protection in place.			

10.4 TEST PROCEDURE

The EUT and its load are placed on a table which is 0.8 meter height. The length of power cord between the coupling device and the EUT shall be 2 meters or less.

For Input and Output AC Power or DC Input and DC Output Power Ports:

The EUT is connected to the power mains through a coupling device that directly couples the Surge interference signal.

The Surge noise shall be applied synchronized to the voltage phase at 0°, 90°, 180°, 270° and the peak value of the AC voltage wave. (5 Positive and 5 Negative)

Each of line-earth and line-line is impressed with a sequence of five surge voltages with interval of 1 minute.

10.5 TEST RESULT

Model: NP-8320

Temperature: 24°C , Humidity: 46 % RH

AC Power Port

Environmental Phenomena	Test Specification	Units	Performance Criteria
Line to Line	±1	KV (Charge Voltage)	A
Line to Earth	±2	KV (Charge Voltage)	A

Final Result:**PASS**

Remark:

Photos of test configuration please refer to appendix 1.

11. IMMUNITY TEST TO CS CONDUCTED DISTURBANCE (CS)

11.1 TEST SETUP

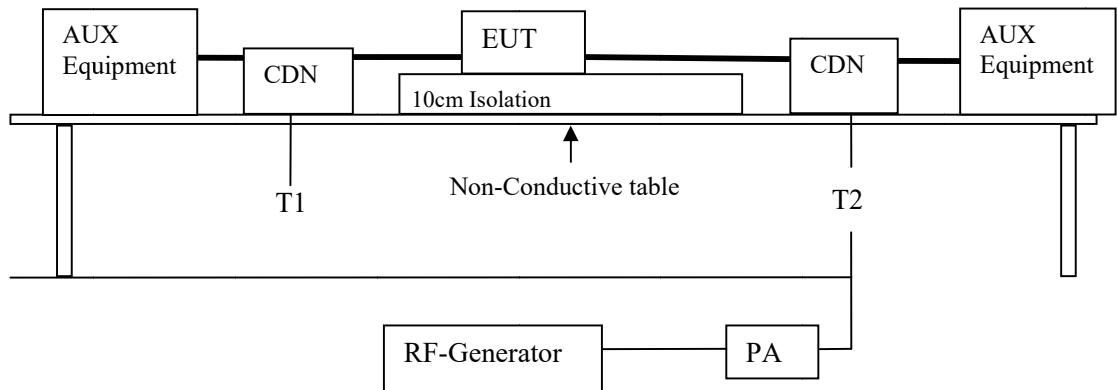

11.2 TEST SPECIFICATION

Test is carried out according to EN61000-4-6, and the Test Level is subject to Table 1 of EN 55024.(Please refer to Page 4 for dated references which are related to the standard as mentioned above)

11.3 TEST LEVEL

Item	Test Specification	Unit	Performance Criteria
Ports for Signal Lines			
Radio-Frequency	0.15 ~ 80	MHz	A
Common Mode	3	V (rms, Unmodulated)	
Amplitude Modulated	80	%AM (1KHz)	
	150	Source Impedance	
Ac Input and AC Output and DC Input and DC output Ports and Functional Earth Ports			
Radio-Frequency	0.15 ~ 80	MHz	
Common Mode	3	V (rms, Unmodulated)	A
Amplitude Modulated	80	%AM (1KHz)	
	150	Source Impedance	



11.4 TEST PROCEDURE

The EUT are placed on a table which is 0.8meter height and a ground reference plane on the table, the EUT are placed upon table and use 10cm insulation between the EUT and ground reference plane.

For AC Input and AC Output Power or DC Input and DC Output Power Ports

The EUT is connected to the power mains through a coupling and decoupling networks for Power supply lines. It also directly couples the disturbance signal into EUT.

Use CDN-M2 for two wires or CDN-M3 for three wires.

For Signal Lines and Control Lines Test:

The disturbance signal is through a coupling and decoupling networks (CDN) or EM-clamp which is to couple the signal and control lines of the EUT.

All scanning frequencies conditions are as following:

Condition of Test	Remarks
EN61000-4-6	
1. Field Strength	3V; Level 2
2. Radiated Signal	AM 80% modulated with 1KHz
3. Scanning Frequencies	0.15MHz ~ 80MHz
4. Dwell Time	3 seconds
5. Frequency step size Δf	1%
6. The rate of swept of frequency	1.5×10^{-3} decades/s

11.5 TEST RESULT

Model: NP-8320

Temperature: 24°C , Humidity: 46 % RH

TEST Specification	Unit	Performance Criteria
0.15 - 80	MHz	A
3	V	
80	% AM (1KHz)	

Final Result:**PASS**

Remark:

Photos of test configuration please refer to appendix 1.

12. POWER FREQUENCY MAGNETIC FIELD (MAGNETIC)

12.1 TEST SETUP

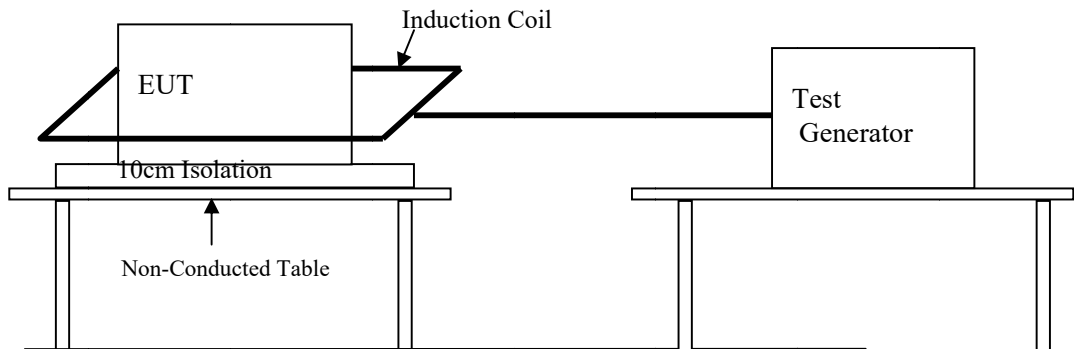

12.2 TEST SPECIFICATION

Test is carried out according to EN61000-4-8, and the Test Level is subject to Table 1 of EN 55024 (Please refer to Page 4 for dated references which are related to the standard as mentioned above)

12.3 TEST LEVEL

Item	Test Specification	Unit	Performance Criteria
Power-Frequency	50	Hz	A
Magnetic Field	1	A/m	

12.4 TEST PROCEDURE

The EUT and its load are placed on a table that is 0.8 meter above the metal ground plane dimension is at least 1 meter x 1 meter. The test magnetic field shall be placed at least than 3 meter distance from the induction coil.

The test magnetic field shall be applied by the immersion method to the EUT. The induction coil shall be rotated by 90° in order to expose the EUT to the test field with different orientation (X, Y, Z orientation).



12.5 TEST RESULT

Model: NP-8320

Temperature: 24°C , Humidity: 46 % RH

Environmental Phenomena	Test Specification	Units	Performance Criteria
Magnetic Field	1	A/m	A

Final Result:**PASS**

Remark:

Photos of test configuration please refer to appendix 1.

13. VOLTAGE DIPS AND INTERRUPTION MEASUREMENT

13.1 TEST SETUP

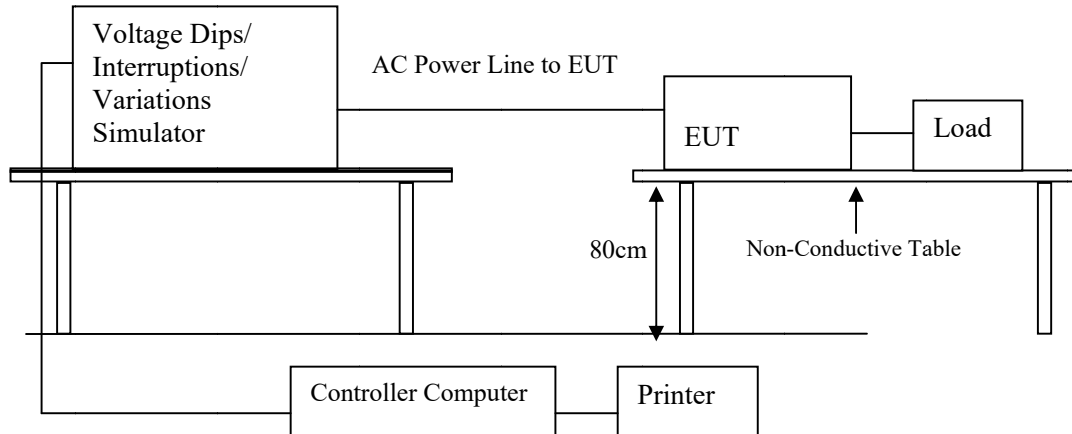

13.2 TEST SPECIFICATION

Test is carried out according to EN61000-4-11, and the Test Level is subject to Table 1 of EN 55024. (Please refer to Page 4 for dated references which are related to the standard as mentioned above)



13.3 TEST LEVEL

Class ^a	Test level and durations for voltage dips				
Class 1	Case-by-case according to the equipment requirements				
Class 2	0 % during 1/2 cycle	0 % during 1 cycle	70 % during 25/30 ^c cycles		
Class 3	0 % during 1/2 cycle	0 % during 1 cycle	40 % during 10/12 ^c cycles	70 % during 25/30 ^c cycles	80 % during 250/300 ^c cycles
Class X ^b	X	X	X	X	X

a: Classes as per EN61000-2-4.

b: To be defined by product committee. For equipment connected directly or indirectly to the public network, the levels must not be less severe than Class 2.

c: “25/30 cycles” means “25 cycles for 50 Hz test” and “30 cycles for 60 Hz tet”.

Class ^a	Test level and durations for short interruptions (t _s) (50Hz / 60Hz)
Class 1	Case-by-case according to the equipment requirements
Class 2	0 % during 250/300 ^c cycles
Class 3	0 % during 250/300 ^c cycles
Class X ^b	X

a: Classes as per EN61000-2-4.

b: To be defined by product committee. For equipment connected directly or indirectly to the public network, the levels must not be less severe than Class 2.

c: “250/300 cycles” means “250 cycles for 50 Hz test” and “300 cycles for 60 Hz test”.

13.4 TEST PROCEDURE

The EUT and its load are placed on a wooden table which is 0.8 meter above a metal ground plane which dimension is 1 meter x 1 meter, the thickness is 0.65mm. It projected beyond the EUT by at least 0.1 meter on all sides. The power cord shall be used the shortest power cord as specified by the manufacturer.

For Voltage Dips / Interruption Test:

The EUT is connected to the power mains through a coupling device that directly couples to the Voltage Dips and Interruption Generator.

The EUT shall be tested for 30% voltage dips of supplied voltage and duration time is 10ms, for 60% voltage dips of supplied voltage and duration time is 100ms with a sequence of three voltage dips with intervals of 10 seconds, and for 95% voltage interruption of supplied voltage and the duration time is 5000ms with a sequence of three voltage interruptions with intervals of 10 seconds.

Voltage phase shifting are shall occur at 0°, 45 °, 90 °, 135 °, 180 °, 225 °, 270 °, 315 ° of the voltage.



13.5 TEST RESULT

Model: NP-8320

Temperature: 24°C , Humidity: 46 % RH

Voltage Dips	Test Level % U _T	Reduction (%)	Duration	Performance Criteria
	<5	>95	0.5 (periods)	B
	70	30	25 (periods)	C

Voltage Interruptions	Test Level % U _T	Reduction (%)	Duration	Performance Criteria
	<5	>95	250(periods) 5000ms	C

Final Result:**PASS**

Remark:*The EUT was influenced during the test, but it returned to normal after the test.*

Photos of test configuration please refer to appendix 1.



14. PERFORMANCE CRITERIA

- A. During and after the test the EUT shall continue to operate as intended without operator intervention. No degradation of performance or loss of function is allowed below a minimum performance level specified by the manufacturer when the EUT is used as intended. The performance level may be replaced by a permissible loss of performance. If the minimum performance level or the permissible performance loss is not specified by the manufacturer, then either of these may be derived from the product description and documentation, and by what the user may reasonably expect from the EUT if used as intended.
- B. After the test, the EUT shall continue to operate as intended without operator intervention. No degradation of performance or loss of function is allowed, after the application of the phenomena below a performance level specified by the manufacturer, when the EUT is used as intended. The performance level may be replaced by a permissible loss of performance. During the test, degradation of performance is allowed. However, no change of operating state or stored data is allowed to persist after the test. If the minimum performance level (or the permissible performance loss) is not specified by the manufacturer, then either of these may be derived from the product description and documentation, and by what the user may reasonably expect from the EUT if used as intended.
- C. During and after testing, a temporary loss of function is allowed, provided the function is self-recoverable, or can be restored by the operation of the controls or cycling of the power to the EUT by the user in accordance with the manufacturer's instructions. Functions, and/or information stored in non-volatile memory, or protected by a battery backup, shall not be lost.



15. EMC MODIFICATION&ESTIMATED MEASUREMENT UNCERTAINTY

15.1 EMC MODIFICATION

No additional EMC solution was made during the Compliance testing.

15.2 ESTIMATED MEASUREMENT UNCERTAINTY

The estimated measurement uncertainty is calculated in accordance with CISPR16-4-2, the total uncertainty for this test is listed as below:

Uncertainty of Conducted Emission Measurement (150KHz~30MHz)

Contribution	Probability Distribution	150KHz – 30MHz
Receiver reading	Normal (k=2)	±0.26
Cable loss	Normal (k=2)	±0.22
AMN insertion loss	Rectangular	±0.3
RCV/SPA specification	Rectangular	±0.36
combined standard uncertainty Ue(y)	Normal	±1.60
Measuring uncertainty for a level of confidence of 95% U=2Ue(y)	Normal (k=2)	±3.2 dB

Uncertainty of Conducted Emission Measurement (9KHz~30MHz) ISN T8

Contribution	Probability Distribution	150KHz – 30MHz
Receiver reading	Normal (k=2)	± 0.14
Cable loss	Normal (k=2)	± 0.22
RCV/SPA specification	Rectangular	± 0.6
combined standard uncertainty Ue(y)	normal	±1.98
Measuring uncertainty for a level of confidence of 95% U=2Ue(y)	normal (k=2)	±3.9

Uncertainty of Radiated Emission Measurement (30MHz~1GHz)

Contribution	Probability Distribution	30MHz~1GHz
Receiver reading	Normal (k=2)	±0.16
Cable loss calibration	Normal (k=2)	±0.22
Antenna factor calibration	Rectangular	±1.00
Pre Amplifier Gain calibration	Rectangular	±0.22
RCV/SPA specification	Rectangular	±0.36
Site Imperfections	Triangular	±1.60
combined standard uncertainty Ue(y)	Normal	±1.38
Measuring uncertainty for a level of confidence of 95% U=2Ue(y)	Normal (k=2)	±2.7 dB



Uncertainty of Radiated Emission Measurement (1GHz~18GHz)

Contribution	Probability Distribution	1GHz~18GHz
Receiver reading	Normal (k=2)	±0.85
Cable loss calibration	Normal (k=2)	±0.61
Antenna factor calibration	Normal (k=2)	±2.00
Pre Amplifier Gain calibration	Normal (k=2)	±0.34
Frequency Response	Rectangular	±0.31
Attenuator	Rectangular	±0.36
Site Imperfections	Triangular	±1.60
Measurement Distance Variation	Rectangular	±0.16
combined standard uncertainty $U_e(y)$	Normal	±2.13
Measuring uncertainty for a level of confidence of 95% $U=2U_e(y)$	Normal (k=2)	±4.2 dB



Global Certification Corp.

Appendix 1

PHOTOS OF TEST CONFIGURATION

01 CE Front View



02 CE Rear View

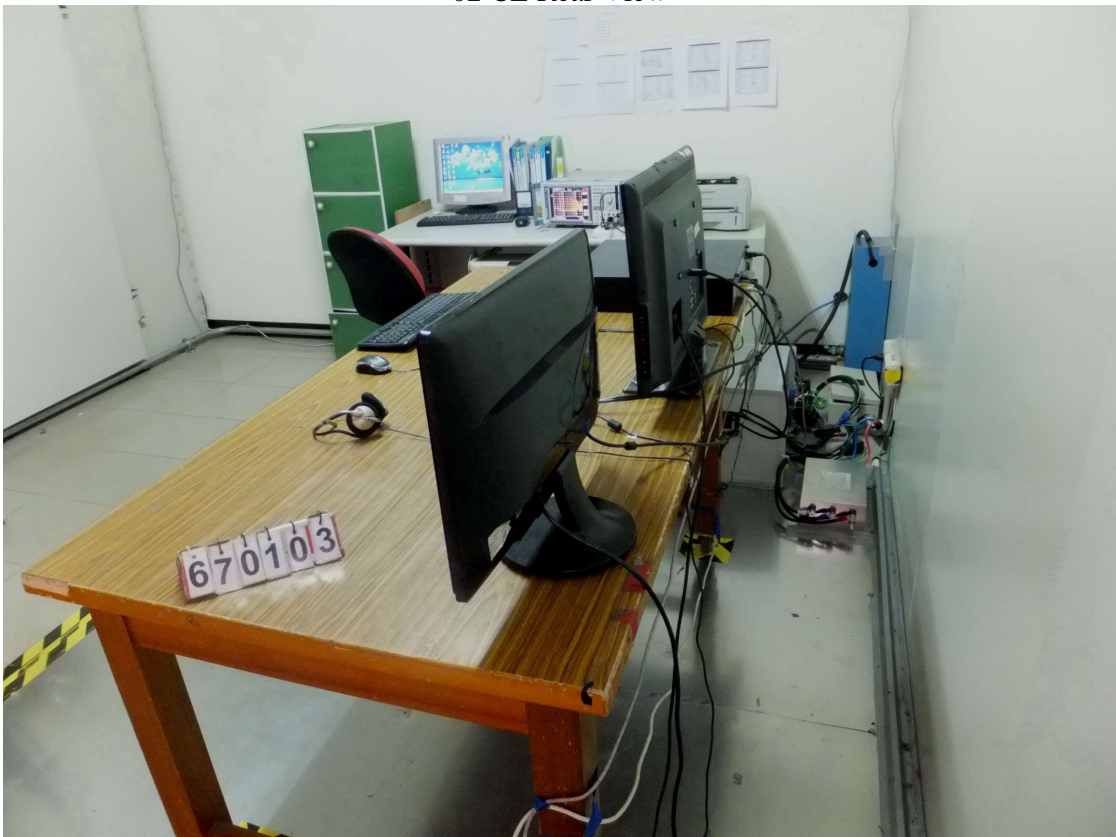

03 RE Front View



04 RE Rear View



05 RE 1-6G Front View (966)



06 RE 1-6G Rear View (966)



07 Harmonics & Flicker & Surge & DIPS



08 ESD



09 RS

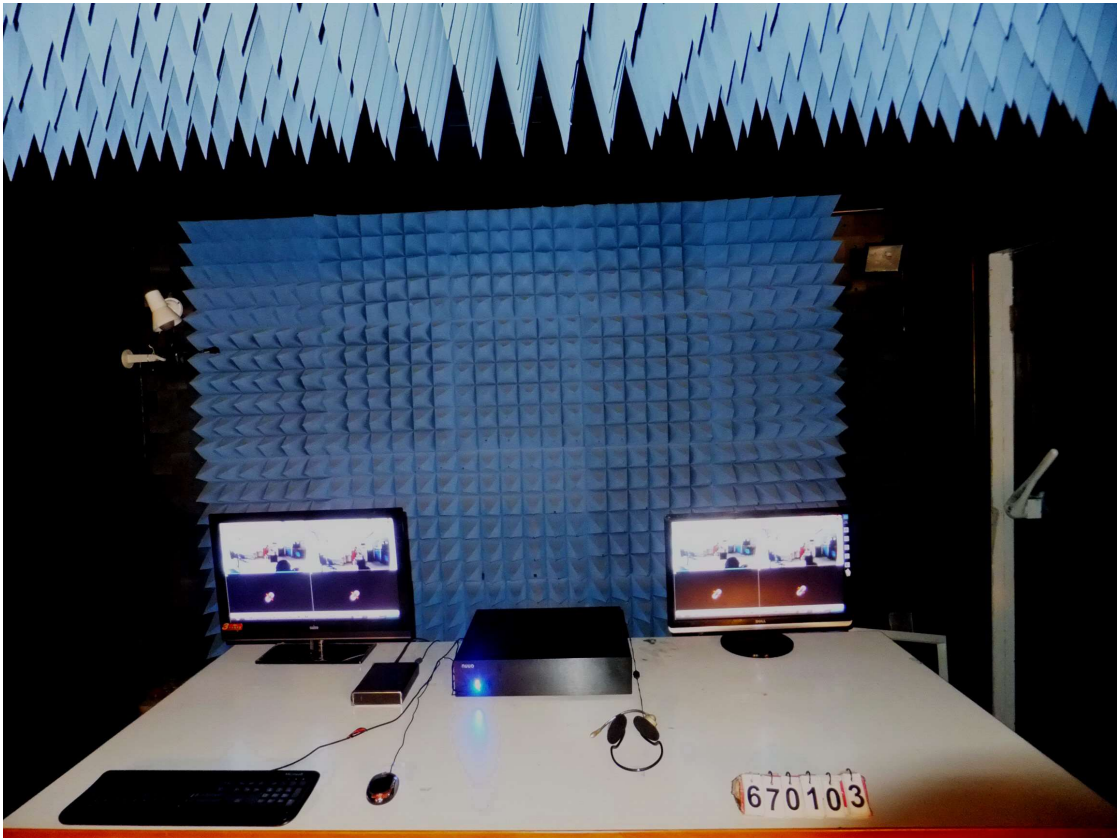

10 EFT

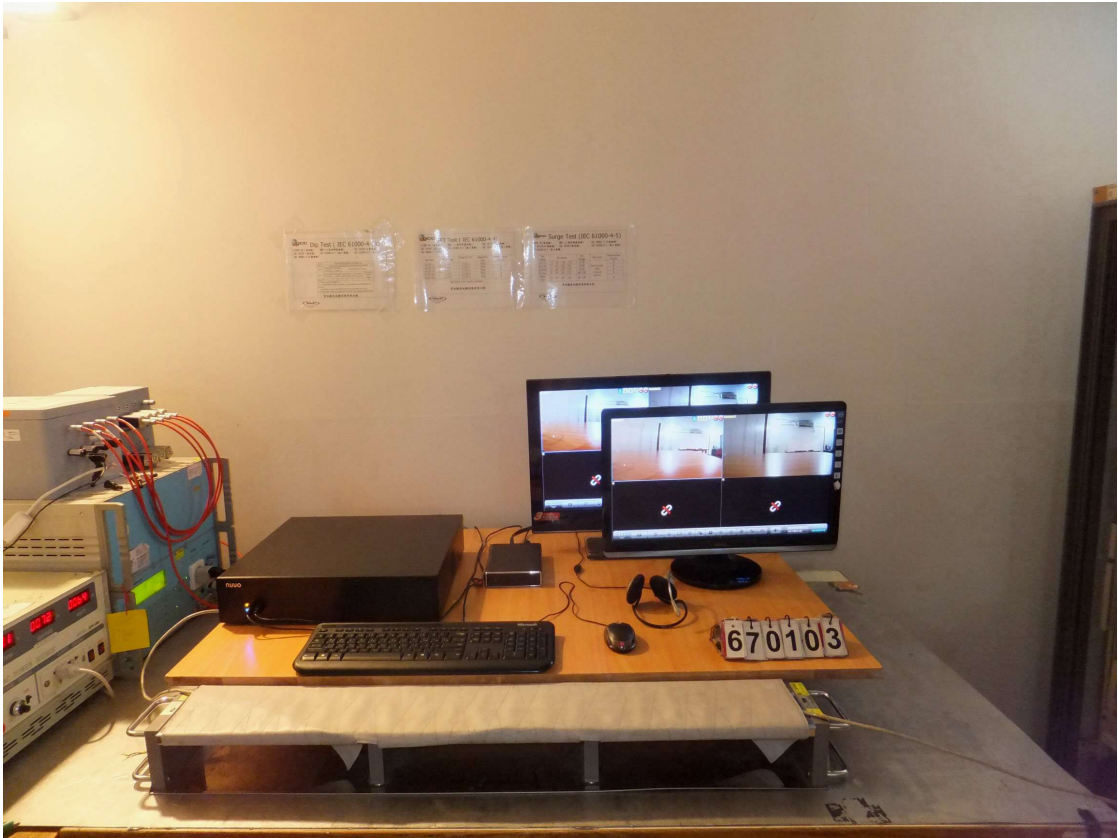

11 CS



12 PFMF





Global Certification Corp.

Appendix 2

TEST DATA

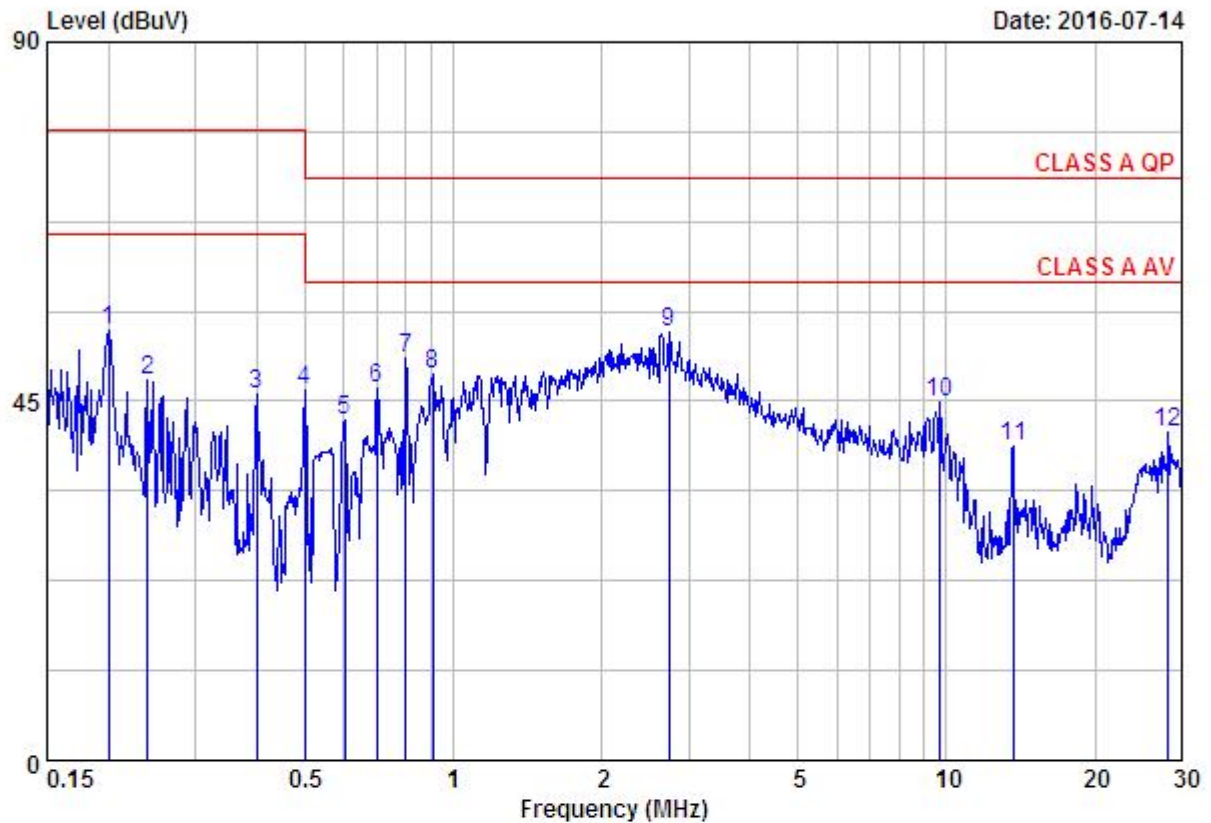

Site : Conduction Test Site 1
 Condition : CLASS A QP LINE
 : RBW:9 KHz VBW:300 KHz
 EUT : See Page 1 of EMC Report
 MODEL : See Page 1 for Details
 Test Mode : Recorder ; LAN 100M
 230Vac 50Hz 27.5°C 56%

Freq	Meter Level	System Factor	Cable Loss	LISN Factor	Real Level	Limit Line	Over Limit	Remark	
MHz	dBuV	dB	dB	dB	dBuV	dBuV	dBuV	dB	
1	0.20	53.89	0.00	0.02	-0.02	53.89	79.00	-25.11	Peak
2	0.24	47.51	0.00	0.02	-0.02	47.51	79.00	-31.49	Peak
3	0.40	45.83	0.00	0.03	-0.03	45.83	79.00	-33.17	Peak
4	0.50	46.40	0.00	0.03	-0.03	46.40	79.00	-32.60	Peak
5	0.60	42.56	0.00	0.03	-0.03	42.56	73.00	-30.44	Peak
6	0.70	46.74	0.00	0.03	-0.03	46.74	73.00	-26.26	Peak
7	0.80	50.44	0.01	0.04	-0.03	50.45	73.00	-22.55	Peak
8	0.91	48.33	0.01	0.04	-0.03	48.34	73.00	-24.66	Peak
9	2.74	53.69	0.02	0.07	-0.05	53.71	73.00	-19.29	Peak
10	9.71	44.90	0.02	0.13	-0.11	44.92	73.00	-28.08	Peak
11	13.62	39.41	0.02	0.15	-0.13	39.43	73.00	-33.57	Peak
12	28.15	41.10	-0.01	0.21	-0.22	41.09	73.00	-31.91	Peak

System Factor = Cable Loss + LISN Factor
 Real Level = Meter Level + System Factor
 Over Limit = Real Level - Limit Line

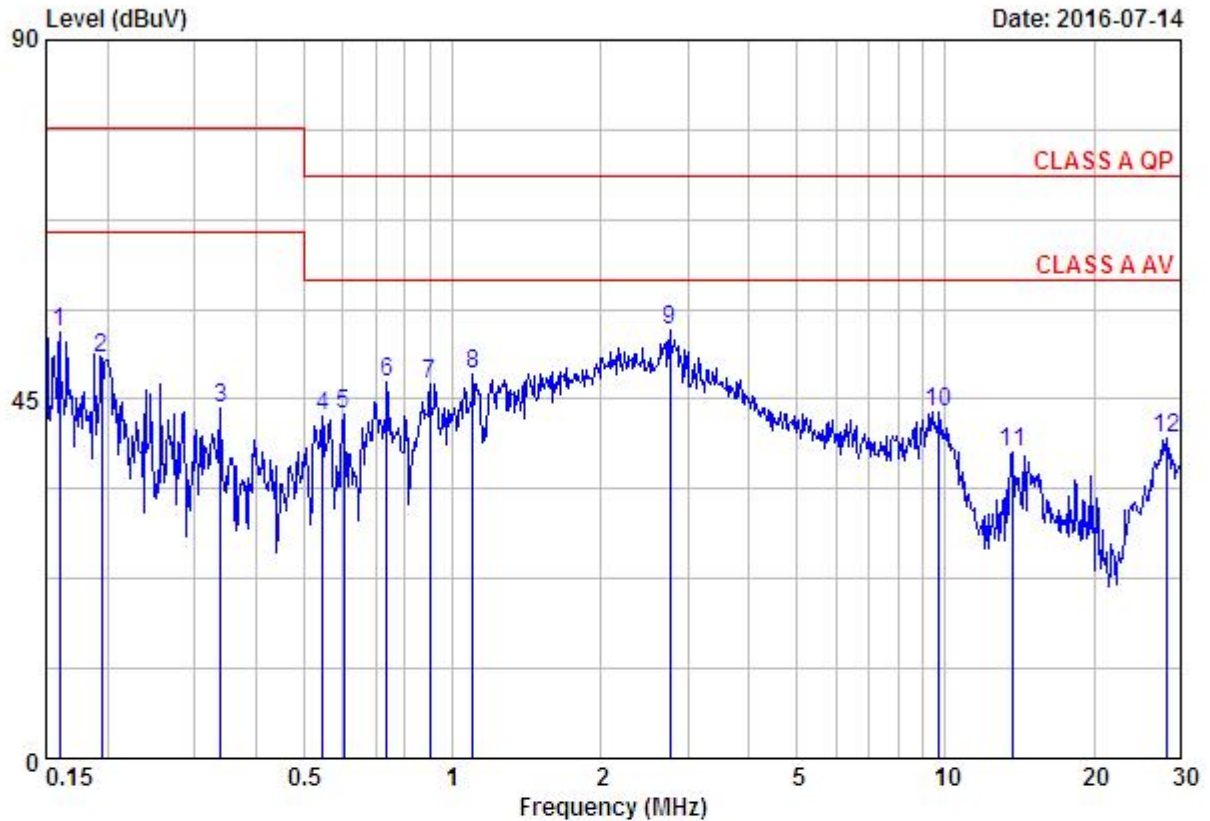

Site : Conduction Test Site 1
 Condition : CLASS A QP NEUTRAL
 : RBW:9 KHz VBW:300 KHz
 EUT : See Page 1 of EMC Report
 MODEL : See Page 1 for Details
 Test Mode : Recorder ; LAN 100M
 230Vac 50Hz 27.5°C 56%

Peak	Freq	Meter Level	System Factor	Cable Loss	LISN Factor	Real Level	Limit Line	Over Limit	Remark
	MHz	dBuV	dB	dB	dB	dBuV	dBuV	dBuV	dB
1	0.16	53.50	0.01	0.02	-0.01	53.51	79.00	-25.49	Peak
2	0.19	50.14	0.01	0.02	-0.01	50.15	79.00	-28.85	Peak
3	0.34	43.92	0.02	0.03	-0.01	43.94	79.00	-35.06	Peak
4	0.55	42.75	0.01	0.03	-0.02	42.76	73.00	-30.24	Peak
5	0.60	43.08	0.01	0.03	-0.02	43.09	73.00	-29.91	Peak
6	0.74	47.02	0.02	0.04	-0.02	47.04	73.00	-25.96	Peak
7	0.90	46.87	0.02	0.04	-0.02	46.89	73.00	-26.11	Peak
8	1.10	48.23	0.01	0.04	-0.03	48.24	73.00	-24.76	Peak
9	2.76	53.67	0.02	0.07	-0.05	53.69	73.00	-19.31	Peak
10	9.71	43.26	0.03	0.13	-0.10	43.29	73.00	-29.71	Peak
11	13.62	38.33	0.02	0.15	-0.13	38.35	73.00	-34.65	Peak
12	28.00	40.04	0.00	0.21	-0.21	40.04	73.00	-32.96	Peak

System Factor = Cable Loss + LISN Factor
 Real Level = Meter Level + System Factor
 Over Limit = Real Level - Limit Line



Date:2016-7-14

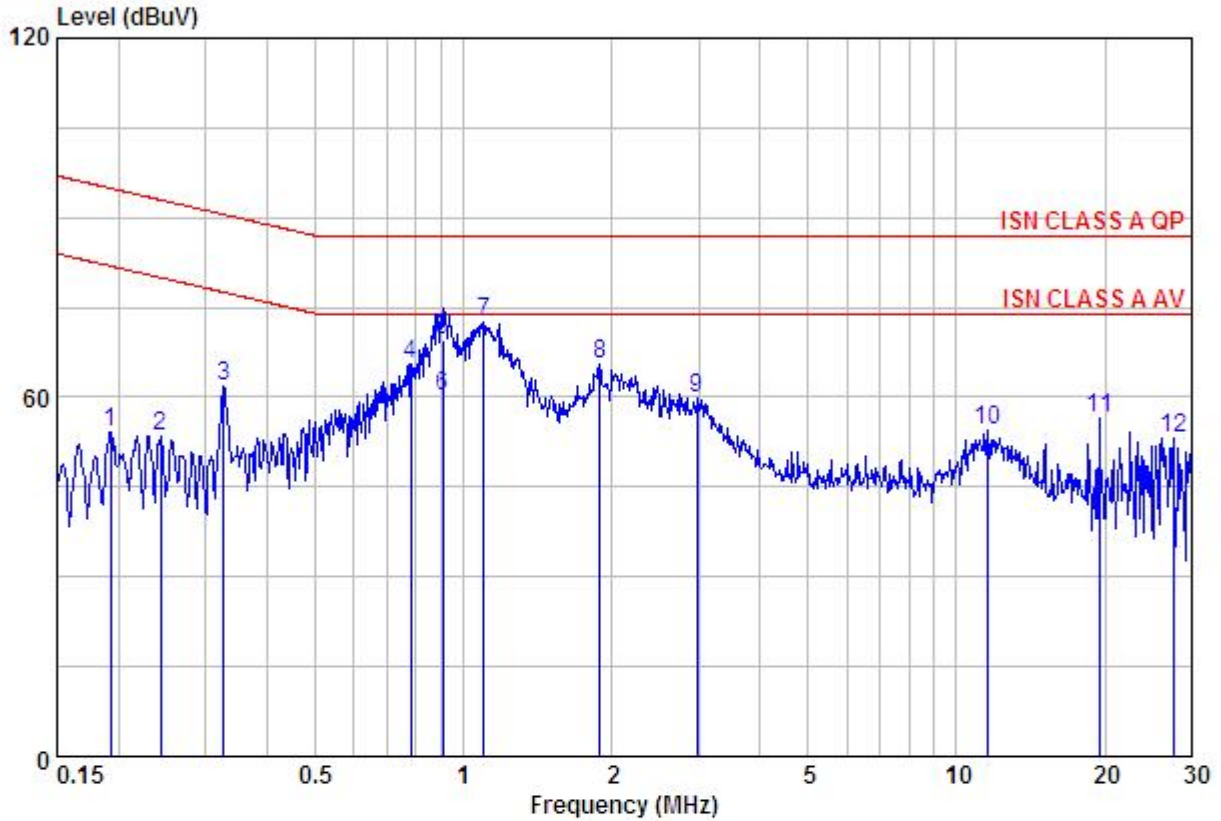

Site : GCC_CE-01
Condition : ISN CLASS A QP
: RBW:9 KHz VBW:300 KHz
EUT : See Page 1 of EMC Report
MODEL : See Page 1 for Details
Test Mode : Recorder ; LAN1 100M
T. / R. H. : 230Vac 50Hz 27.5°C 56%

	Meter	System	Cable	ISN	Real	Limit	Over		
Freq	Level	Factor	Loss	Factor	Level	Line	Limit	Remark	
MHz	dBuV	dB	dB	dB	dBuV	dBuV	dBuV	dB	
1	0.19	44.13	10.14	0.02	10.12	54.27	94.93	-40.66	Peak
2	0.24	43.34	10.07	0.02	10.05	53.41	93.00	-39.59	Peak
3	0.33	51.89	10.01	0.03	9.98	61.90	90.53	-28.63	Peak
4	0.78	55.76	9.85	0.04	9.81	65.61	87.00	-21.39	Peak
5	0.91	59.80	9.83	0.04	9.79	69.63	87.00	-17.37	QP
6	0.91	50.20	9.83	0.04	9.79	60.03	74.00	-13.97	Average
7	1.10	62.61	9.81	0.04	9.77	72.42	87.00	-14.58	Peak
8	1.89	55.64	9.78	0.06	9.72	65.42	87.00	-21.58	Peak
9	2.98	49.99	9.77	0.07	9.70	59.76	87.00	-27.24	Peak
10	11.56	44.48	9.91	0.14	9.77	54.39	87.00	-32.61	Peak
11	19.43	46.27	10.18	0.18	10.00	56.45	87.00	-30.55	Peak
12	27.56	42.66	10.56	0.21	10.35	53.22	87.00	-33.78	Peak

System Factor = Cable Loss + ISN Factor
Real Level = Meter Level + System Factor
Over Limit = Real Level - Limit Line



Date:2016-7-14

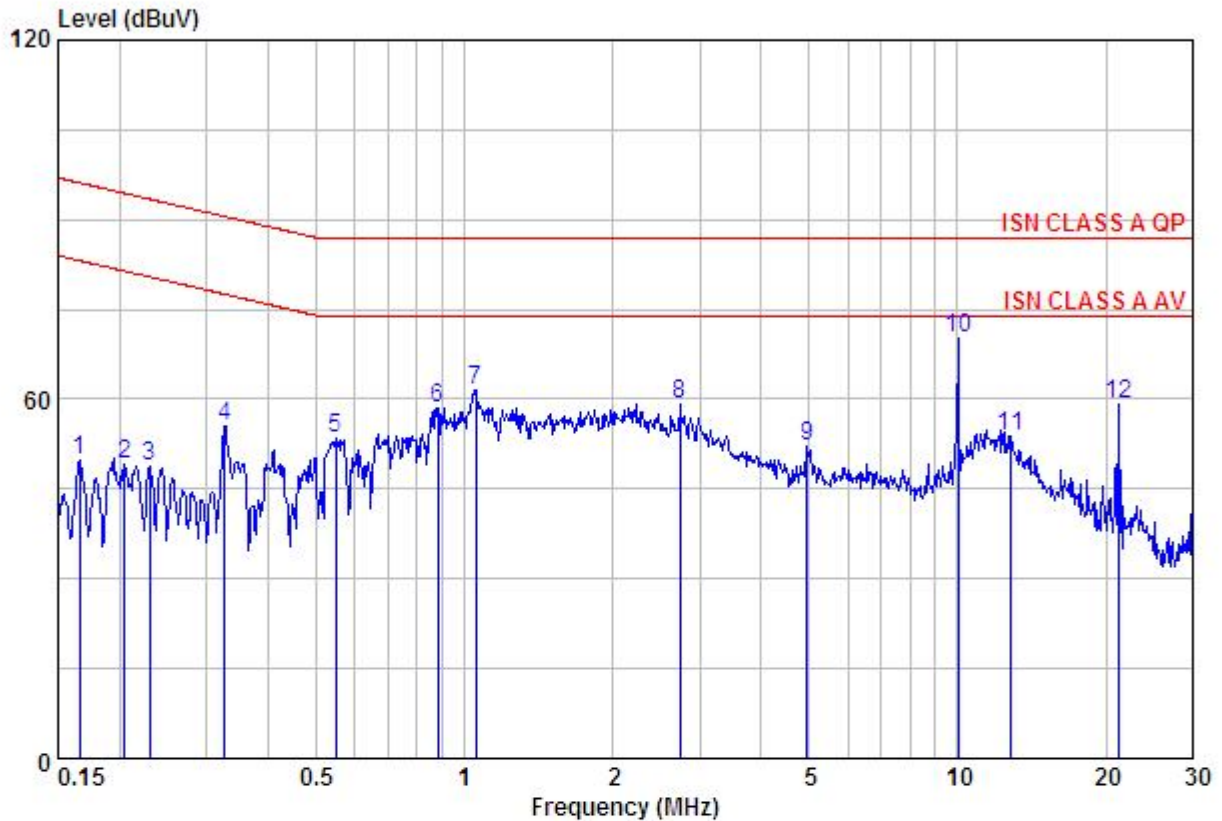

Site : GCC_CE-01
Condition : ISN CLASS A QP
: RBW:9 KHz VBW:300 KHz
EUT : See Page 1 of EMC Report
MODEL : See Page 1 for Details
Test Mode : Recorder ; LAN1 10M
T. / R. H. : 230Vac 50Hz 27.5°C 56%

	Meter	System	Cable	ISN	Real	Limit	Over		
Freq	Level	Factor	Loss	Factor	Level	Line	Limit	Remark	
MHz	dBuV	dB	dB	dB	dBuV	dBuV	dBuV	dB	
1	0.17	39.46	10.22	0.02	10.20	49.68	96.16	-46.48	Peak
2	0.21	39.09	10.11	0.02	10.09	49.20	94.40	-45.20	Peak
3	0.23	38.63	10.08	0.02	10.06	48.71	93.44	-44.73	Peak
4	0.33	45.46	10.01	0.03	9.98	55.47	90.53	-35.06	Peak
5	0.55	43.57	9.89	0.03	9.86	53.46	87.00	-33.54	Peak
6	0.88	48.80	9.84	0.04	9.80	58.64	87.00	-28.36	Peak
7	1.05	51.82	9.81	0.04	9.77	61.63	87.00	-25.37	Peak
8	2.74	49.40	9.77	0.07	9.70	59.17	87.00	-27.83	Peak
9	4.95	42.28	9.77	0.09	9.68	52.05	87.00	-34.95	Peak
10	10.02	60.17	9.87	0.13	9.74	70.04	87.00	-16.96	Peak
11	12.85	43.88	9.94	0.14	9.80	53.82	87.00	-33.18	Peak
12	21.15	48.90	10.25	0.18	10.07	59.15	87.00	-27.85	Peak

System Factor = Cable Loss + ISN Factor
Real Level = Meter Level + System Factor
Over Limit = Real Level - Limit Line



Date:2016-7-14

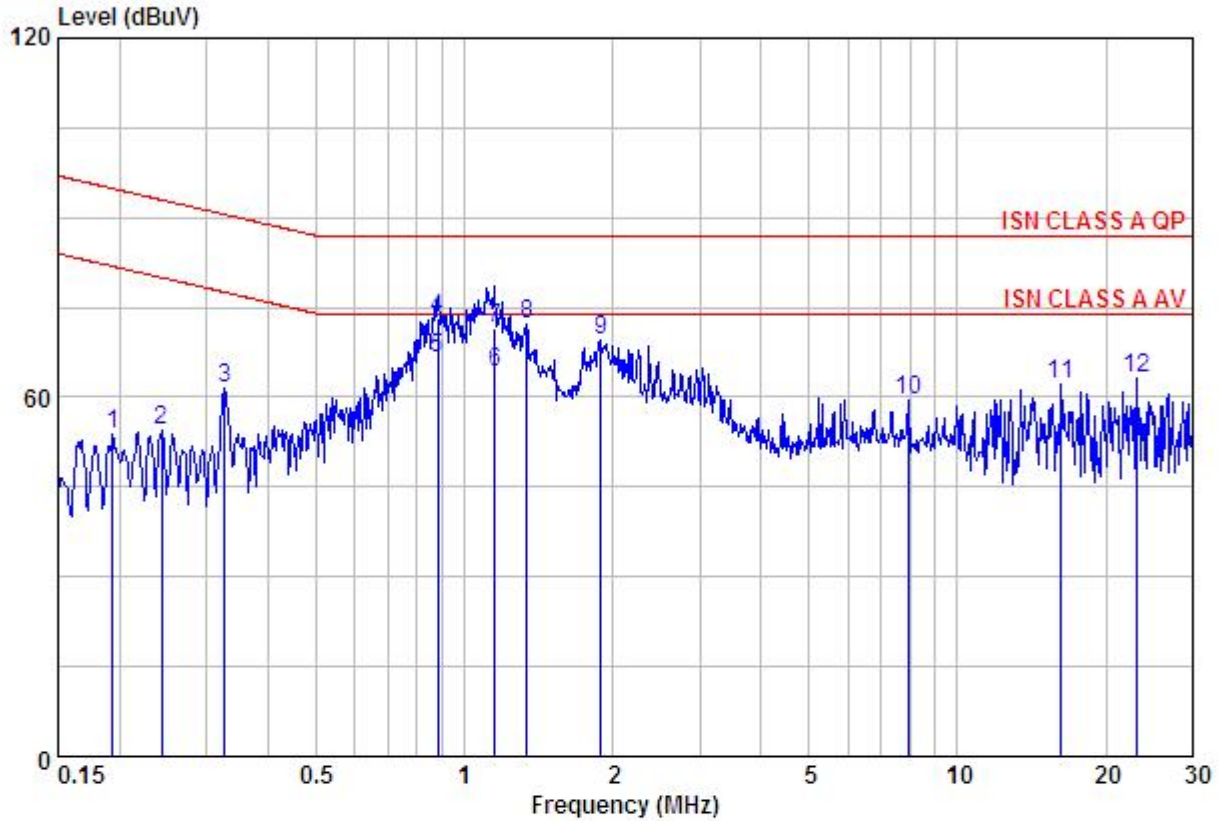

Site : GCC_CE-01
Condition : ISN CLASS A QP
: RBW:9 KHz VBW:300 KHz
EUT : See Page 1 of EMC Report
MODEL : See Page 1 for Details
Test Mode : Recorder ; LAN2
T. / R. H. : 230Vac 50Hz 27.5°C 56%

	Meter	System	Cable	ISN	Real	Limit	Over		
Freq	Level	Factor	Loss	Factor	Level	Line	Limit	Remark	
MHz	dBuV	dB	dB	dB	dBuV	dBuV	dBuV	dB	
1	0.19	43.53	10.14	0.02	10.12	53.67	94.89	-41.22	Peak
2	0.24	44.28	10.07	0.02	10.05	54.35	93.00	-38.65	Peak
3	0.33	51.52	10.01	0.03	9.98	61.53	90.53	-29.00	Peak
4	0.88	63.49	9.84	0.04	9.80	73.33	87.00	-13.67	QP
5	0.88	56.69	9.84	0.04	9.80	66.53	74.00	-7.47	Average
6	1.15	54.30	9.81	0.04	9.77	64.11	74.00	-9.89	Average
7	1.15	61.80	9.81	0.04	9.77	71.61	87.00	-15.39	QP
8	1.34	62.55	9.80	0.05	9.75	72.35	87.00	-14.65	Peak
9	1.89	59.77	9.78	0.06	9.72	69.55	87.00	-17.45	Peak
10	7.94	49.63	9.84	0.12	9.72	59.47	87.00	-27.53	Peak
11	16.23	52.19	10.04	0.16	9.88	62.23	87.00	-24.77	Peak
12	23.14	52.84	10.35	0.19	10.16	63.19	87.00	-23.81	Peak

System Factor = Cable Loss + ISN Factor
Real Level = Meter Level + System Factor
Over Limit = Real Level - Limit Line

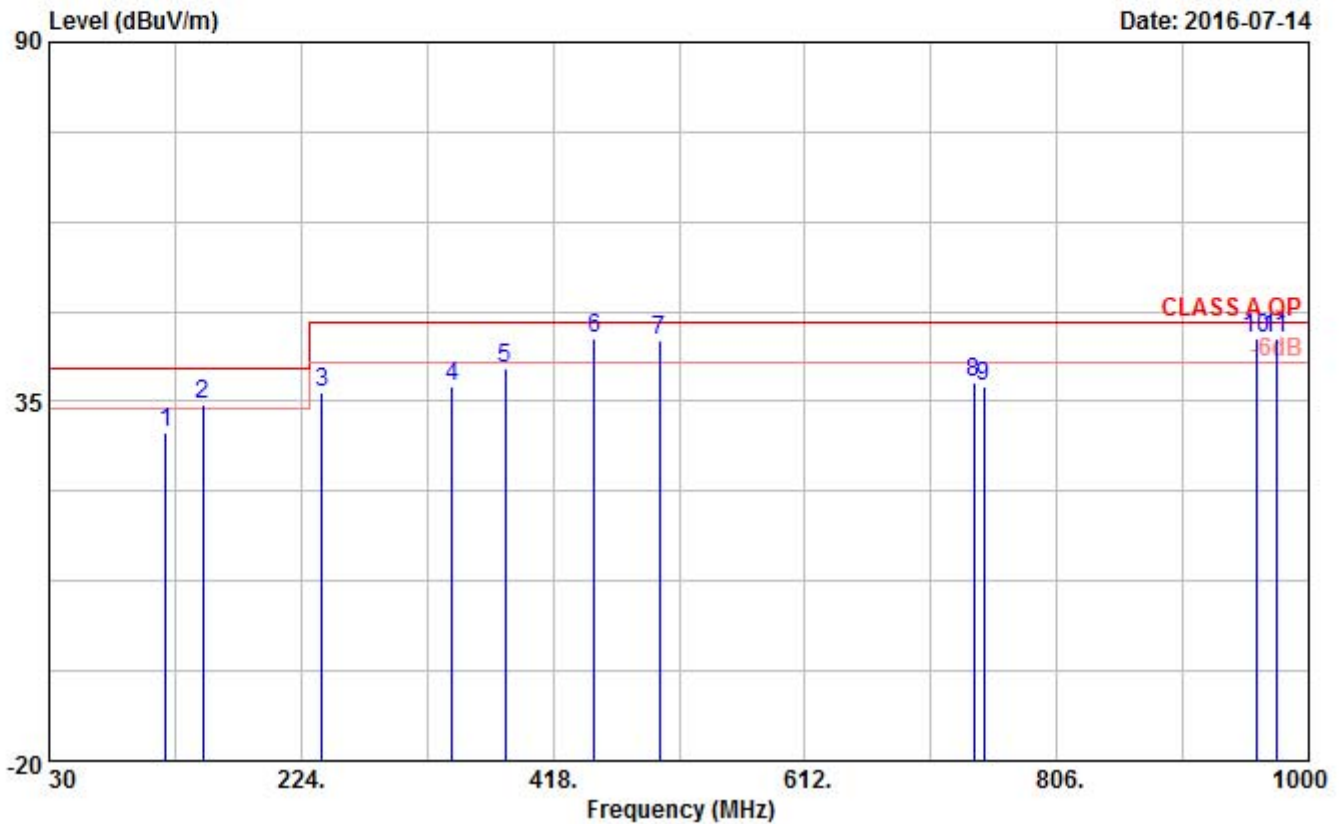

Site : GCC_RE-01
Condition : CLASS A QP VERTICAL
: RBW:120 KHz VBW:300 KHz
EUT : See Page 1 of EMC Report
MODEL : See Page 1 for Details
Test mode : Recorder ; LAN 100M
230Vac 50Hz 28.5°C 59%

	Meter	System	Cable	Antenna	Preamp	Real	Limit	Over	
	Freq	Level	Factor	Loss	Factor	Gain	Level	Line	Limit Remark
	MHz	dBuV	dB/m	dB	dB/m	dB	dBuV/m	dBuV/m	dB
1	120.00	44.38	-14.24	2.25	14.30	30.79	30.14	40.00	-9.86 QP
2	148.34	49.98	-15.47	2.50	12.83	30.80	34.51	40.00	-5.49 QP
3	240.00	52.29	-15.96	3.28	11.60	30.84	36.33	47.00	-10.67 QP
4	340.40	49.96	-12.59	4.07	14.21	30.87	37.37	47.00	-9.63 QP
5	381.14	51.31	-11.40	4.33	15.15	30.88	39.91	47.00	-7.09 QP
6	450.00	53.67	-9.11	4.74	17.00	30.85	44.56	47.00	-2.44 QP
7	500.01	52.09	-7.88	5.03	17.90	30.81	44.21	47.00	-2.79 QP
8	741.98	40.87	-2.84	6.29	21.00	30.13	38.03	47.00	-8.97 QP
9	750.01	39.93	-2.67	6.33	21.10	30.10	37.26	47.00	-9.74 QP
10	960.00	43.49	1.26	7.37	23.26	29.37	44.75	47.00	-2.25 QP
11	975.00	42.90	1.62	7.44	23.50	29.32	44.52	47.00	-2.48 QP

System Factor = Cable Loss + Antenna Factor - Preamp Gain
Real Level = Meter Level + System Factor
Over Limit = Real Level - Limit Line

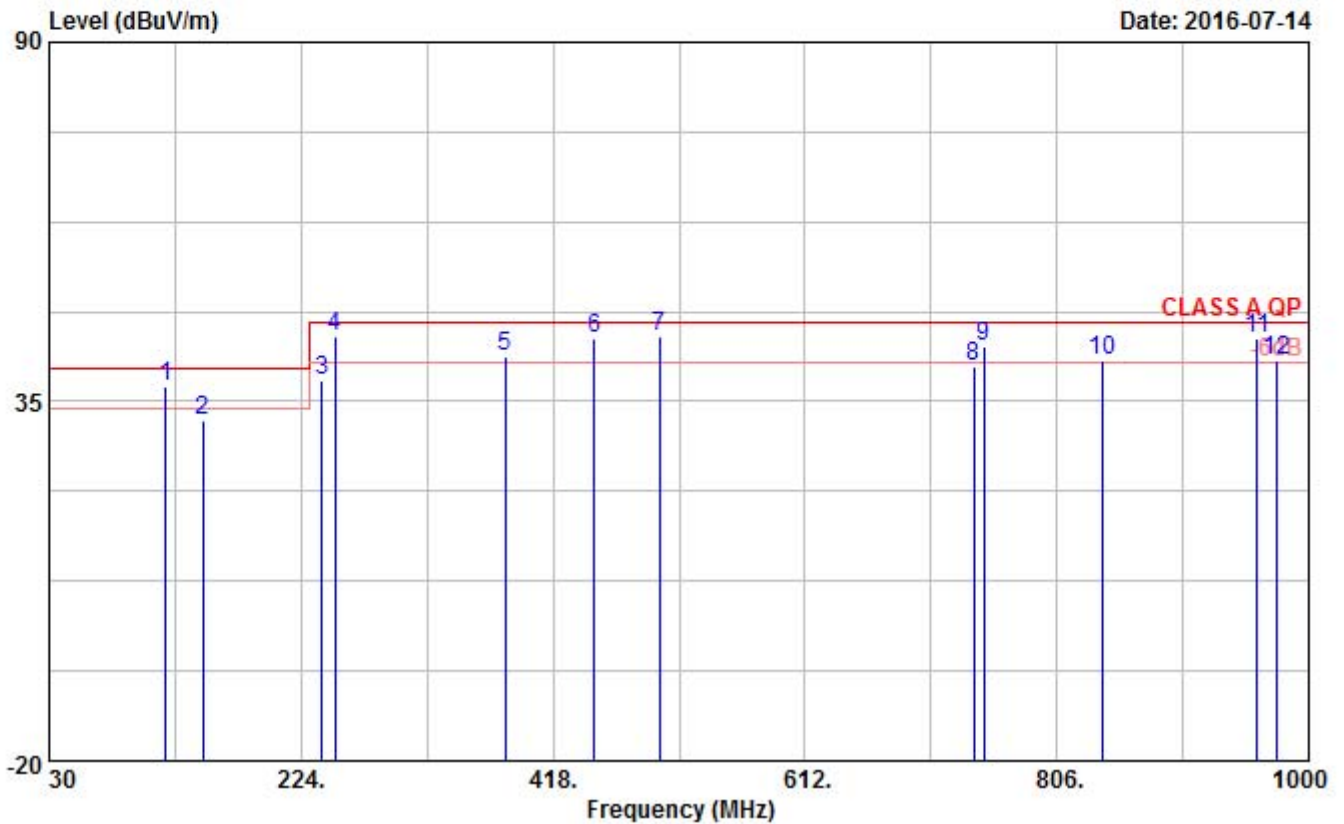

Site : GCC_RE-01
 Condition : CLASS A QP HORIZONTAL
 : RBW:120 KHz VBW:300 KHz
 EUT : See Page 1 of EMC Report
 MODEL : See Page 1 for Details
 Test mode : Recorder ; LAN 100M
 230Vac 50Hz 28.5°C 59%

	Meter	System	Cable	Antenna	Preamp	Real	Limit	Over	
	Freq	Level	Factor	Loss	Factor	Gain	Level	Line	Limit Remark
	MHz	dBuV	dB/m	dB	dB/m	dB	dBuV/m	dBuV/m	dB
1	120.00	51.40	-14.24	2.25	14.30	30.79	37.16	40.00	-2.84 QP
2	148.34	47.69	-15.47	2.50	12.83	30.80	32.22	40.00	-7.78 QP
3	240.01	54.05	-15.96	3.28	11.60	30.84	38.09	47.00	-8.91 QP
4	250.02	60.86	-15.89	3.36	11.60	30.85	44.97	47.00	-2.03 QP
5	381.14	53.21	-11.40	4.33	15.15	30.88	41.81	47.00	-5.19 QP
6	450.02	53.82	-9.11	4.74	17.00	30.85	44.71	47.00	-2.29 QP
7	500.01	52.71	-7.88	5.03	17.90	30.81	44.83	47.00	-2.17 QP
8	741.98	43.27	-2.84	6.29	21.00	30.13	40.43	47.00	-6.57 QP
9	750.01	46.20	-2.67	6.33	21.10	30.10	43.53	47.00	-3.47 QP
10	840.92	42.35	-0.92	6.79	22.05	29.76	41.43	47.00	-5.57 QP
11	960.02	43.27	1.26	7.37	23.26	29.37	44.53	47.00	-2.47 QP
12	974.78	39.65	1.60	7.43	23.50	29.33	41.25	47.00	-5.75 QP

System Factor = Cable Loss + Antenna Factor - Preamp Gain
 Real Level = Meter Level + System Factor
 Over Limit = Real Level - Limit Line



Data: 3

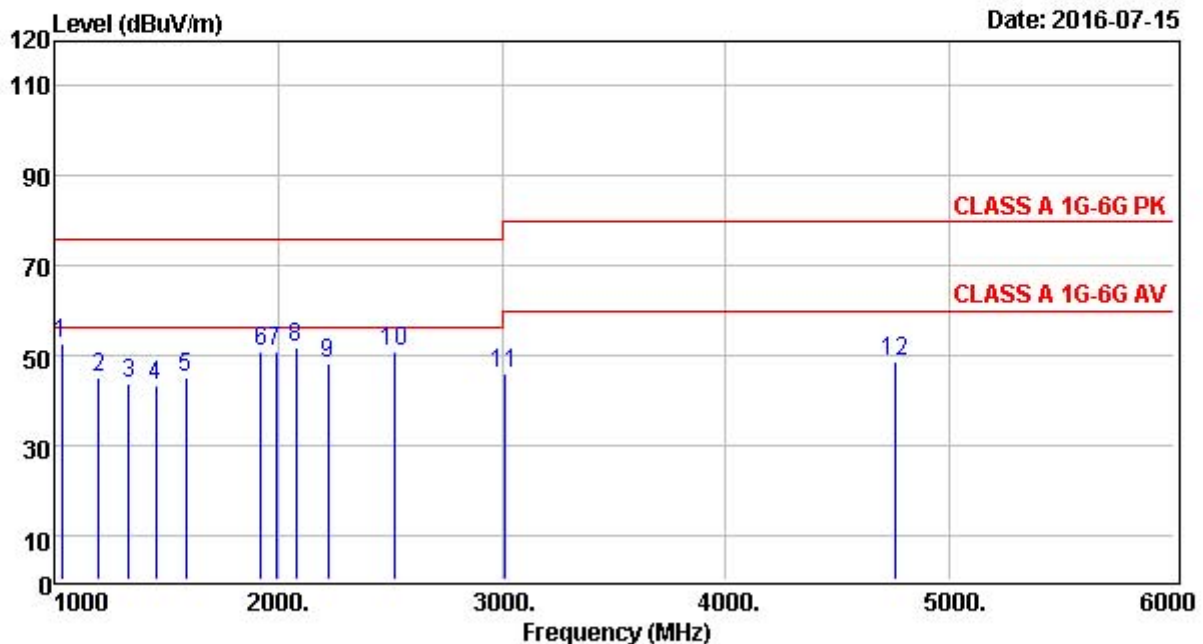

Site : GCC_RE-02
Condition : CLASS A 1G-6G PK VERTICAL
: RBW:1000 VBW:1000
EUT : See Page 1 of EMC Report
MODEL : See Page 1 for Details
MEMO : Recorder ; LAN 100M
T/H : 230Vac 50Hz 27.8°C 59%
:
:

	Meter	System	Cable	Antenna	Preamp	Real	Limit	Over	
Freq	Level	Factor	Loss	Factor	Gain	Level	Line	Limit	Remark
	MHz	dBuV	dB/m	dB	dB/m	dB	dBuV/m	dBuV/m	dB
1	1035.00	76.93	-24.31	2.81	28.07	55.19	52.62	76.00	-23.38 Peak
2	1200.00	69.31	-24.28	3.04	27.94	55.26	45.03	76.00	-30.97 Peak
3	1335.00	67.82	-24.25	3.24	27.83	55.32	43.57	76.00	-32.43 Peak
4	1455.00	67.31	-24.22	3.41	27.74	55.37	43.09	76.00	-32.91 Peak
5	1590.00	68.27	-23.37	3.61	28.38	55.36	44.90	76.00	-31.10 Peak
6	1925.00	70.98	-20.17	4.15	30.93	55.25	50.81	76.00	-25.19 Peak
7	1990.00	70.58	-19.55	4.25	31.42	55.22	51.03	76.00	-24.97 Peak
8	2080.00	70.78	-19.24	4.34	31.60	55.18	51.54	76.00	-24.46 Peak
9	2225.00	67.04	-18.87	4.46	31.77	55.10	48.17	76.00	-27.83 Peak
10	2520.00	68.82	-18.13	4.71	32.12	54.96	50.69	76.00	-25.31 Peak
11	3010.00	63.38	-17.36	5.19	32.70	55.25	46.02	80.00	-33.98 Peak
12	4755.00	62.86	-14.41	6.54	34.00	54.95	48.45	80.00	-31.55 Peak

System Factor = Cable Loss + Antenna Factor - Preamp Gain
Real Level = Meter Level + System Factor
Over Limit = Real Level - Limit Line



Data: 4

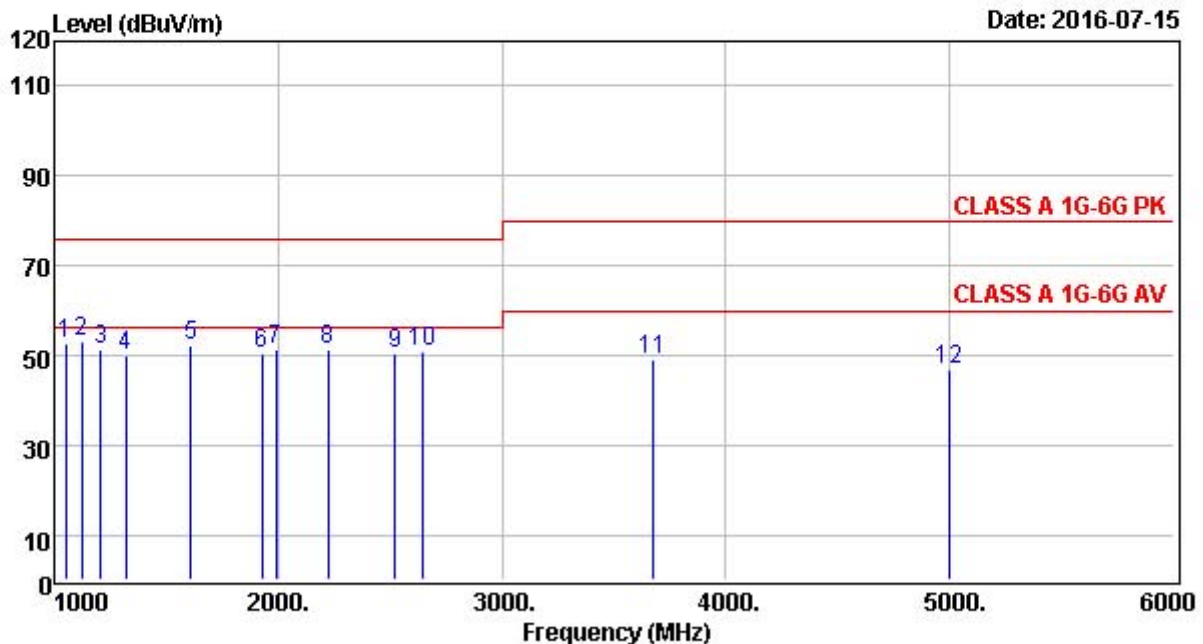

Site : GCC RE-02
 Condition : CLASS A 1G-6G PK HORIZONTAL
 : RBW:1000 VBW:1000
 EUT : See Page 1 of EMC Report
 MODEL : See Page 1 for Details
 MEMO : Recorder ; LAN 100M
 T/H : 230Vac 50Hz 27.8°C 59%
 :
 :

	Meter	System	Cable	Antenna	Preamp	Real	Limit	Over	
Freq	Level	Factor	Loss	Factor	Gain	Level	Line	Limit	Remark
	MHz	dBuV	dB/m	dB	dB/m	dB	dBuV/m	dBuV/m	dB
1	1050.00	76.76	-24.30	2.83	28.06	55.19	52.46	76.00	-23.54 Peak
2	1125.00	77.21	-24.28	2.94	28.00	55.22	52.93	76.00	-23.07 Peak
3	1210.00	75.39	-24.27	3.06	27.93	55.26	51.12	76.00	-24.88 Peak
4	1320.00	74.02	-24.26	3.21	27.84	55.31	49.76	76.00	-26.24 Peak
5	1610.00	75.44	-23.16	3.65	28.54	55.35	52.28	76.00	-23.72 Peak
6	1930.00	70.65	-20.11	4.16	30.97	55.24	50.54	76.00	-25.46 Peak
7	1990.00	70.79	-19.55	4.25	31.42	55.22	51.24	76.00	-24.76 Peak
8	2225.00	70.25	-18.87	4.46	31.77	55.10	51.38	76.00	-24.62 Peak
9	2525.00	68.63	-18.13	4.71	32.13	54.97	50.50	76.00	-25.50 Peak
10	2645.00	68.94	-17.94	4.83	32.27	55.04	51.00	76.00	-25.00 Peak
11	3675.00	65.36	-16.45	5.76	32.92	55.13	48.91	80.00	-31.09 Peak
12	5000.00	60.80	-14.17	6.65	34.00	54.82	46.63	80.00	-33.37 Peak

System Factor = Cable Loss + Antenna Factor - Preamp Gain
 Real Level = Meter Level + System Factor
 Over Limit = Real Level - Limit Line

Harmonics – Class-A per Ed. 3.2 (2009)(Run time)

EUT: Network Video Recorder Tested by: Bob
Test category: Class-A per Ed. 3.2 (2009) (European limits) Test Margin: 100
Test date: 2016/7/13
Data file name: H-000231.cts_data
Comment: 20160713
Customer: 670103

Test Result: Pass Source qualification: Normal

Current & voltage waveforms

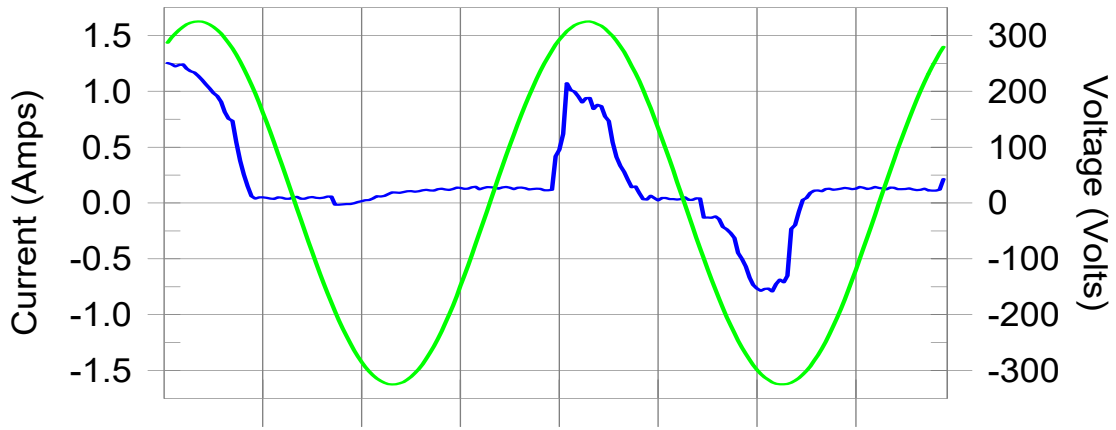

Harmonics and Class A limit line European Limits

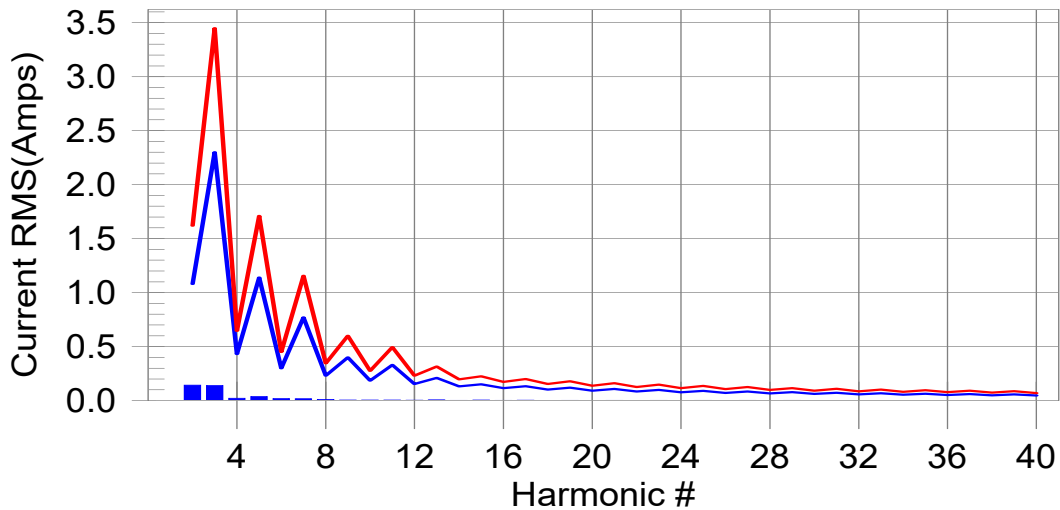

Test result: Pass Worst harmonic was #2 with 8.81% of the limit.

Current Test Result Summary (Run time)

EUT: Network Video Recorder Tested by: Bob
Test category: Class-A per Ed. 3.2 (2009) (European limits) Test Margin: 100
Test date: 2016/7/13
Data file name: H-000231.cts_data
Comment: 20160713
Customer: 670103

Test Result: Pass Source qualification: Normal
THC(A): 0.16 I-THD(%): 54.19 POHC(A): 0.000 POHC Limit(A): 0.251

Highest parameter values during test:

V_RMS (Volts): 229.88	Frequency(Hz): 50.00
I_Peak (Amps): 1.259	I_RMS (Amps): 0.465
I_Fund (Amps): 0.312	Crest Factor: 2.989
Power (Watts): 67.5	Power Factor: 0.746

Harm#	Harms(avg)	100%Limit	%of Limit	Harms(max)	150%Limit	%of Limit	Status
2	0.095	1.080	8.8	0.142	1.620	8.79	Pass
3	0.127	2.300	5.5	0.141	3.450	4.09	Pass
4	0.016	0.430	3.8	0.022	0.645	3.37	Pass
5	0.027	1.140	2.4	0.038	1.710	2.21	Pass
6	0.011	0.300	3.7	0.018	0.450	3.95	Pass
7	0.013	0.770	1.6	0.017	1.155	1.51	Pass
8	0.007	0.230	3.2	0.011	0.345	3.12	Pass
9	0.004	0.400	1.0	0.005	0.600	0.84	Pass
10	0.005	0.184	2.5	0.006	0.276	2.02	Pass
11	0.004	0.330	1.2	0.006	0.495	1.25	Pass
12	0.003	0.153	1.7	0.003	0.230	1.47	Pass
13	0.004	0.210	2.0	0.006	0.315	2.03	Pass
14	0.002	0.131	1.4	0.002	0.197	1.24	Pass
15	0.003	0.150	1.9	0.004	0.225	1.91	Pass
16	0.002	0.115	1.7	0.003	0.173	1.51	Pass
17	0.002	0.132	1.7	0.004	0.199	1.77	Pass
18	0.001	0.102	1.1	0.002	0.153	1.05	Pass
19	0.002	0.118	1.5	0.003	0.178	1.44	Pass
20	0.001	0.092	1.5	0.002	0.138	1.50	Pass
21	0.002	0.107	1.8	0.003	0.161	1.70	Pass
22	0.001	0.084	1.4	0.002	0.125	1.24	Pass
23	0.002	0.098	1.7	0.002	0.147	1.52	Pass
24	0.001	0.077	1.2	0.001	0.115	1.09	Pass
25	0.002	0.090	1.8	0.003	0.135	1.87	Pass
26	0.001	0.071	1.3	0.001	0.106	1.32	Pass
27	0.002	0.083	1.8	0.002	0.125	1.94	Pass
28	0.001	0.066	1.5	0.001	0.099	1.25	Pass
29	0.002	0.078	2.2	0.002	0.116	2.00	Pass
30	0.001	0.061	1.6	0.001	0.092	1.50	Pass
31	0.001	0.073	1.8	0.002	0.109	1.69	Pass
32	0.001	0.058	2.0	0.002	0.086	1.91	Pass
33	0.001	0.068	2.0	0.002	0.102	1.75	Pass
34	0.001	0.054	1.4	0.001	0.081	1.34	Pass
35	0.001	0.064	1.4	0.001	0.096	1.39	Pass
36	0.001	0.051	1.8	0.001	0.077	1.65	Pass
37	0.001	0.061	1.6	0.001	0.091	1.54	Pass
38	0.001	0.048	1.5	0.001	0.073	1.37	Pass
39	0.001	0.058	1.3	0.001	0.087	1.52	Pass
40	0.001	0.046	1.7	0.001	0.069	1.48	Pass

Voltage Source Verification Data (Run time)

EUT: Network Video Recorder Tested by: Bob
Test category: Class-A per Ed. 3.2 (2009) (European limits) Test Margin: 100
Test date: 2016/7/13
Data file name: H-000231.cts_data
Comment: 20160713
Customer: 670103

Test Result: Pass Source qualification: Normal

Highest parameter values during test:

Voltage (Vrms):	229.88	Frequency(Hz):	50.00
I_Peak (Amps):	1.259	I_RMS (Amps):	0.465
I_Fund (Amps):	0.312	Crest Factor:	2.989
Power (Watts):	67.5	Power Factor:	0.746

Harm#	Harmonics	V-rms	Limit V-rms	% of Limit	Status
2		0.104	0.460	22.56	OK
3		0.474	2.069	22.92	OK
4		0.020	0.460	4.44	OK
5		0.056	0.920	6.04	OK
6		0.013	0.460	2.73	OK
7		0.022	0.690	3.15	OK
8		0.017	0.460	3.76	OK
9		0.021	0.460	4.49	OK
10		0.012	0.460	2.54	OK
11		0.010	0.230	4.52	OK
12		0.015	0.230	6.41	OK
13		0.012	0.230	5.37	OK
14		0.008	0.230	3.69	OK
15		0.008	0.230	3.47	OK
16		0.014	0.230	5.94	OK
17		0.013	0.230	5.87	OK
18		0.017	0.230	7.22	OK
19		0.006	0.230	2.70	OK
20		0.017	0.230	7.48	OK
21		0.010	0.230	4.36	OK
22		0.008	0.230	3.55	OK
23		0.005	0.230	2.02	OK
24		0.008	0.230	3.50	OK
25		0.007	0.230	2.89	OK
26		0.011	0.230	4.65	OK
27		0.006	0.230	2.78	OK
28		0.008	0.230	3.56	OK
29		0.007	0.230	3.13	OK
30		0.009	0.230	3.90	OK
31		0.009	0.230	4.00	OK
32		0.012	0.230	5.42	OK
33		0.016	0.230	7.05	OK
34		0.015	0.230	6.35	OK
35		0.014	0.230	6.24	OK
36		0.013	0.230	5.71	OK
37		0.011	0.230	4.73	OK
38		0.009	0.230	3.83	OK
39		0.007	0.230	2.90	OK
40		0.013	0.230	5.77	OK

Flicker Test Summary per EN/IEC61000-3-3 (Run time)

EUT: Network Video Recorder
Test category: All parameters (European limits)
Test date: 2016/7/13
Data file name: F-000285.cts_data
Comment: 20160713
Customer: 670103

Tested by: Bob
Test Margin: 100

Test Result: Pass

Status: Test Completed

Pst_i and limit line

European Limits

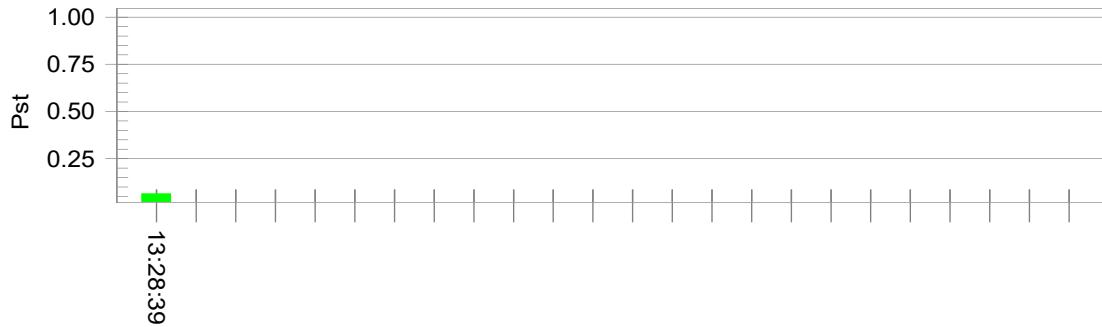

Plt and limit line

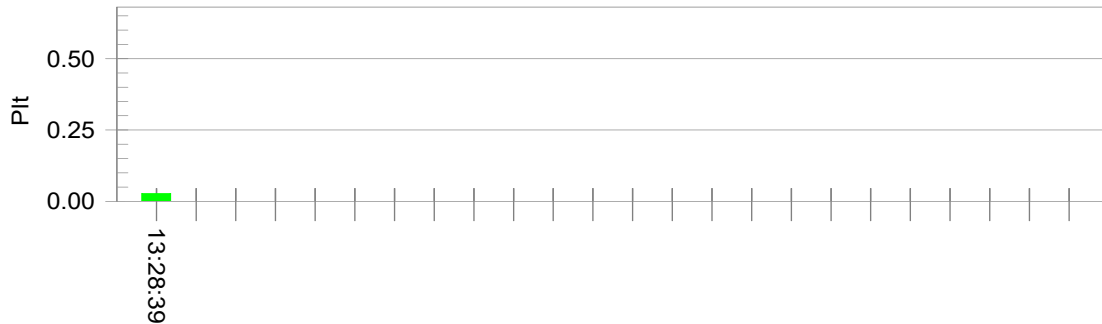

Parameter values recorded during the test:

Vrms at the end of test (Volt):	229.78		
Highest dt (%):	0.00	Test limit (%):	N/A N/A
T-max (mS):	0	Test limit (mS):	500.0 Pass
Highest dc (%):	0.00	Test limit (%):	3.30 Pass
Highest dmax (%):	0.00	Test limit (%):	4.00 Pass
Highest Pst (10 min. period):	0.064	Test limit:	1.000 Pass
Highest Plt (2 hr. period):	0.028	Test limit:	0.650 Pass