



CE EMC TEST REPORT

FOR

Network Video Recorder

Model : NP-2160, NP-20X0, NP-2XX0, NVP-20X0, NVP-200X,
NVP-2XX0, NVR-BK2XX(X=0~16)

Trade Name: NUUO

Issued to

NUUO Inc.

10F., No.285, Sec. 2, Wenhua Rd. Banqiao Dist., New Taipei City 220, Taiwan
(R.O.C.)

Issued by

Global Certification Corp.

No.146, Sec. 2, Xiangzhang Rd., Xizhi Dist., New Taipei City 221,
Taiwan (R.O.C.)



Note: This test refers exclusively to the test presented test model and sample. This report shall not be reproduced except in full, without the written approval of Global Certification Corporation. This document may be altered or revised by Global Certification Corporation. Personnel only, and shall be noted in the revision section of the document.



Revision History

Revision	No.	Report Number	Issue Date	Description	Author/ Revised by
1.	810203	810203	Feb. 05, 2018	Original Report	Judy



TABLE OF CONTENTS	3
1. GENERAL INFORMATION	6
1.1 DESCRIPTION OF THE TESTED SAMPLES	7
1.2 I/O PORT OF THE EUT	7
1.3 TEST METHODOLOGY	8
1.4 DESCRIPTION OF THE SUPPORT EQUIPMENT	9
1.5 FEATURES OF EUT	10
2. INSTRUMENT AND CALIBRATION	11
2.1 MEASURING INSTRUMENT CALIBRATION	11
2.2 TEST AND MEASUREMENT EQUIPMENT	11
2.3 TEST PERFORMED	12
2.4 APPENDIX	13
3. CONDUCTED EMISSION MEASUREMENT	15
3.1 TEST SETUP	15
3.2 LIMIT	15
3.3 TEST PROCEDURE	15
3.4 TEST SPECIFICATION	16
3.5 TEST DATA:	16
3.6 RESULT	16
3.7 LIMIT OF CONDUCTED COMMON MODE DISTURBANCE AT TELECOMMUNICATION PORTS	16
3.8 TEST DATA	16
3.9 RESULT	16
4. RADIATED EMISSION MEASUREMENT	17
4.1 TEST SETUP	17
4.2 LIMIT	19
4.3 TEST PROCEDURE	20
4.4 TEST SPECIFICATION	20
4.5 TEST DATA	20
4.6 RESULT	20
5. CONDUCTED DIFFERENTIAL VOLTAGE EMISSIONS MEASUREMENT	21
5.1 TEST SETUP	21
5.2 LIMIT	22
5.3 TEST PROCEDURE	23
5.4 TEST SPECIFICATION	24
5.5 TEST DATA	24
5.6 RESULT	24
6. HARMONIC CURRENT EMISSIONS MEASUREMENT	25
6.1 TEST SETUP	25
6.2 LIMIT OF HARMONIC CURRENT	25
6.3 TEST PROCEDURE	25
6.4 TEST SPECIFICATION	25
6.5 TEST DATA	25
6.6 RESULT	25
7. VOLTAGE FLUCTUATIONS	26
7.1 TEST SETUP	26
7.2 VOLTAGE FLUCTUATIONS TEST	26
7.3 TEST PROCEDURE	26
7.4 TEST SPECIFICATION	26
7.5 TEST DATA	26



7.6	RESULT	26
8.	ELECTROSTATIC DISCHARGE IMMUNITY TEST (ESD)	27
8.1	TEST SPECIFICATION	27
8.2	TEST SETUP	27
8.3	TEST LEVEL	27
8.4	TEST RESULT	28
9.	RADIATED SUSCEPTIBILITY MEASUREMENT (RS)	32
9.1	TEST SETUP	32
9.2	TEST SPECIFICATION	32
9.3	TEST LEVEL	32
9.4	TEST PROCEDURE	33
9.5	TEST RESULT	33
10.	ELECTRICAL FAST TRANSIENT/BURST (EFT)	34
10.1	TEST SETUP	34
10.2	TEST SPECIFICATION	34
10.3	TEST PROCEDURE	34
10.4	TEST LEVEL	35
10.5	TEST RESULT	35
11.	SURGE	36
11.1	TEST SETUP	36
11.2	TEST SPECIFICATION	36
11.3	TEST LEVEL	36
11.4	TEST PROCEDURE	37
11.5	TEST RESULT	37
12.	IMMUNITY TEST TO CS CONDUCTED DISTURBANCE (CS)	38
12.1	TEST SETUP	38
12.2	TEST SPECIFICATION	38
12.3	TEST LEVEL	38
12.4	TEST PROCEDURE	39
12.5	TEST RESULT	39
13.	POWER FREQUENCY MAGNETIC FIELD (MAGNETIC)	40
13.1	TEST SETUP	40
13.2	TEST SPECIFICATION	40
13.3	TEST LEVEL	40
13.4	TEST PROCEDURE	40
13.5	TEST RESULT	41
14.	VOLTAGE DIPS AND INTERRUPTION MEASUREMENT	42
14.1	TEST SETUP	42
14.2	TEST SPECIFICATION	42
14.3	TEST LEVEL	43
14.4	TEST PROCEDURE	43
14.5	TEST RESULT	44
15.	PERFORMANCE CRITERIA	45
16.	EMC MODIFICATION & ESTIMATED MEASUREMENT UNCERTAINTY	46
16.1	EMC MODIFICATION	46
16.2	ESTIMATED MEASUREMENT UNCERTAINTY	46

APPENDIX 1

PHOTOS OF TEST CONFIGURATION



APPENDIX 2

TEST DATA

APPENDIX 3

PHOTOS OF EUT



1. GENERAL INFORMATION

Applicant : NUUO Inc.
Address : 10F., No.285, Sec. 2, Wenhua Rd. Banqiao Dist., New Taipei City 220, Taiwan (R.O.C.)
Manufacturer : NUUO Inc.
Address : 10F., No.285, Sec. 2, Wenhua Rd. Banqiao Dist., New Taipei City 220, Taiwan (R.O.C.)
EUT : Network Video Recorder
Model No. : NP-2160, NP-20X0, NP-2XX0, NVP-20X0, NVP-200X, NVP-2XX0, NVR-BK2XX(X=0~16)
Trade Name : NUUO
Model Differences : **The major electrical and mechanical constructions of series models are identical to the basic model, except different software and for ODM. The model, NP-2160 is the testing sample, and the final test data are shown on this test report.**

Test Standards:

EMI : Class B

EN 55032: 2015

EN 61000-3-2:2014

EN 61000-3-3:2013

EMS :

EN 55024:2010

EN 61000-4-2 : 2009

EN 61000-4-3 : 2006+A2:2010

EN 61000-4-4 : 2012

EN 61000-4-5 : 2014

EN 61000-4-6 : 2014

EN 61000-4-8 : 2010

EN 61000-4-11 : 2004

According to the applicant's declaration this EUT is a Class B product.

The above equipment was tested by Global Certification Corp. For compliance with the requirements set forth in the EUROPEAN COUNCIL Directive 2014/30/EU and the technical standards mentioned above. The results of testing in this report apply only to the product/system, which was tested.

The test was carried out on Jan. 31, 2018 and this test report shall not be reproducing in part without written approval of Global Certification Corp.

Tested By:

Approved by:

Feb. 05, 2018
Date

Eason Hsu, Engineer

Feb. 05, 2018
Date

Adam Chou, Manager



1.1 DESCRIPTION OF THE TESTED SAMPLES

EUT

EUT Type : Normal Type Engineering Type

EUT Name : Network Video Recorder

Model No. : NP-2160

EUT Power Type : AC Power
 DC Power
 DCV from PC
 DCV from Adaptor

EUT Power Rating : I/P: 100~240Vac, 50~60Hz, 1.8A
O/P: 12Vdc  5.0A, 60W

The frequency of the EUT

Highest Operating Frequency : 2GHz

EUT Received Date : Dec. 26, 2017

EMC Test Completed Date : Jan. 31, 2018

1.2 I/O PORT OF THE EUT

I/O port type	Q'ty	Tested with
USB Type A Port	5	5
VGA Port	1	1
HDMI Port	1	1
RS232 Port	1	1
LAN Port	2	2
eSATA Port	1	1
Audio Port	3	3



1.3 TEST METHODOLOGY

EUT SYSTEM OPERATION

1. The EUT was configured according to EN55032 Class B
2. All I/O ports are connected to the appropriate peripherals.
3. Photos of test configuration please refer to appendix 1.
4. Perform the EMC testing procedures, and measure the maximum emission noise.
5. The combined texts of the International Standard CISPR 32:2015 with agreed common modifications were approved by CENELEC as EN 55032:2015
6. EUT Operating Mode: A Full screen consisting of repeated "H" or "Color bar" patterns should be continuously scrolled down under EMCTEST.

DECISION OF FINAL TEST MODE

The EUT was pre-tested under operating condition .

The power rating of EUT is designed with AC power of rating 100-240Vac, 50/60Hz. For radiated and conducted emission evaluation, 230Vac($\pm 10\%$)/50Hz & 110Vac($\pm 10\%$)/60Hz ,had been covered during the pre-test. The worst data was recorded in the applied test report.

Harmonic , Flick and Immunity testing power were 230Vac/50Hz.

Mode : Recording 1920*1080



1.4 DESCRIPTION OF THE SUPPORT EQUIPMENT

Setup Diagram

See test photographs attached in appendix 1 for the actual connections between EUT and support equipment.

Support Equipment

Peripherals Devices:

OUTSIDE SUPPORT EQUIPMENT							
No.	Equipment	Model	Serial No.	FCC ID/ BSMI ID	Trade name	Data Cable	Power Cord
1.	MONITOR	288P6L	AU5A142 1009987	DOC	PHILIPS	Shielded 1.8m	Unshielded 1.8m
2.	MONITOR	P2415Qb	CN-OGTT PW-74261 -SCN-06G L	DOC	Dell	Shielded 1.8m	Unshielded 1.8m
3.	USB3.0 storage	TS8GJF700	N/A	DOC	TRANSCE ND	Shielded 1.0m	N/A
4.	USB3.0 storage	TS8GJF700	N/A	DOC	TRANSCE ND	Shielded 1.0m	N/A
5.	USB3.0 storage	TS8GJF700	N/A	DOC	TRANSCE ND	Shielded 1.0m	N/A
6.	MOUSE	62278	622783291 607150580 7	DOC	steelseries	Unshielded 1.8m / USB	N/A
7.	KEY BOARD	SK-8115	N/A	DOC	DELL	Shielded 1.2m / USB	N/A
8.	EAR PHONE	E220	N/A	N/A	DeeJay	Unshielded 2m	N/A
9.	eSATA	N/A	N/A	N/A	N/A	Unshielded 0.5m	N/A
10.	HDD	N/A	N/A	N/A	Akiti	N/A	N/A
11.	NB	P L41SA1	SZSL41S A1745005 18	DOC	ELITEGRO UP	Unshielded 15m	Unshielded 1.8m
12.	CCD	E911	N/A	N/A	ACTi	Unshielded 1.8m	N/A
EUT ACCESSORIES/COMPONEBNTS							
No.	Equipment	Model	Serial No.	FCC ID/ BSMI ID	Trade name	Data Cable	Power Cord
1.	PCB1	NEW N8-V0.1	N/A	N/A	N/A	N/A	N/A
2.	PCB2	FP-PWR REV:2.0	N/A	N/A	NUUO	N/A	N/A
3.	PCB3	FP-USB REV:1.0	N/A	N/A	NUUO	N/A	N/A
4.	Adapter	PA1060-120T IA500	N/A	VOC	Powertron	N/A	Unshielded 1.8m



5.	FAN	MF40101V1-1Q01U-S99	N/A	N/A	SUNON	N/A	N/A
6.	remote controller	N/A	N/A	N/A	NUUO	N/A	N/A
7.	Power Cable	N/A	N/A	N/A	N/A	N/A	Unshielded 0.8m
8.	DC Cable	N/A	N/A	N/A	N/A	Unshielded 1.4m	N/A

Note: All the above equipment/cable were placed in worse case position to maximize emission signals during emission test.

Grounding: Grounding was in accordance with the manufacturer's requirement and conditions for the intended use.

1.5 FEATURES OF EUT

Please refer to user manual or product specification.



2. INSTRUMENT AND CALIBRATION

2.1 MEASURING INSTRUMENT CALIBRATION

The measuring equipment utilized to perform the tests documented in the report has been calibrated once a year or in accordance with the manufacturer’s recommendations, and is traceable to recognized national standards.

2.2 TEST AND MEASUREMENT EQUIPMENT

The following list contains measurement equipment used for testing. The equipment conforms to the requirement of CISPR 16-1-1, CISPR16-1-4, CISPR 16-2-3 and other required standards.

Calibration of all test and measurement, including any accessories that may effect such calibration, is checked frequently to ensure the accuracy. Adjustments are made and correction factors are applied in accordance with the instructions contained in the respective.

TABLE 1 LIST OF TEST AND MEASUREMENT EQUIPMENT

Conducted Emission Measurement (Test Site ID: GCC_CE-01)					
Instrument	Manufacturer	Model No.	Serial No.	Calibration Due Date	Note
EMC Test Receiver	R&S	ESCI	100438	Dec. 08, 2018	
LISN #1	SCHWARZBECK	NNLK8121	550213	Aug. 19, 2018	For EUT
LISN #2	EMCO	Feb-25	9001-1400	N/A	For Support Unit
RF Cable	Huber+Suhner	RG223/U	Cable-001	Dec.17, 2018	
Impedance Stabilization	Teseq GmbH	ISNT800	23334	Nov. 08, 2018	
Absorbing Clamp	COM-POWER	AB-050	421915	Aug. 17,2019	
RF Cable	Huber+Suhner	5D-FB	CABLE-007	Aug. 16,2019	
Test Software	AUDIX	E3	6.2008-10-2C	N/A	
3m/10m Open Area Test Site Radiated Emission Measurement (Test Site ID: GCC_RE-01)					
Instrument	Manufacturer	Model No.	Serial No.	Calibration Due Date	Note
EMC Test Receiver	R&S	FSV40	101088	Sep. 28, 2018	
Bilog Antenna	SUNOL	JB1	A052104	Oct. 25, 2018	
RF Cable	JYE BAO	RG214/U	Cable-002	Sep. 27, 2018	
Pre-Amplifier	WIRELESS	FPA-6592G	60021	Oct. 20, 2018	
Test Software	AUDIX	E3	6.2009-5-7a(n)gcc	N/A	
966 3m EMC Chamber Radiated Emission Measurement (Test Site ID: GCC_RE-02 and GCC_RE-02G)					
Instrument	Manufacturer	Model No.	Serial No.	Calibration Due Date	Note
EMC Test Receiver	R&S	FSV40	101088	Sep. 28, 2018	
Bilog Antenna	SUNOL	JB1	A052204	Feb. 21, 2018	
Pre-Amplifier	WIRELESS	FPA-6592G	60028	Sep. 28, 2018	
RF Cable NSA Rx	HUBER + UHNER	RG213/U	Cable-004	Sep. 27, 2018	
Double Ridged Guide HORN ANTENNA	EST.LINDGREN	3117	119028	Apr.18, 2019	
SMA Cable	HUBER SUHNER	EMC104-SM-SM-10	170238	Mar. 05, 2018	



		00			
RF Cable (sVSWR TX)	Huber Suhnr	SUCOFLEX 104	293864/4	Mar. 05, 2018	
Microwave Preamplifier	EMCINSTRUMENT	EMC051845	980059	Apr. 17, 2019	
TEST SOFTWARE	AUDIX	E3	6.101222	N/A	
Power Harmonic and Voltage Fluctuations Measurement (Test Site ID: GCC_HF-01)					
Instrument	Manufacturer	Model No.	Serial No.	Calibration Due Date	Note
5KV AC Power Source	SCHAFFNER	NSG1007	55869	Sep. 20, 2018	
Signal Conditioning	SCHAFFNER	CCN1000-1	72281	Sep. 20, 2018	
EMS					
Instrument	Manufacturer	Model No.	Serial No.	Calibration Due Date	Note
EN61000-4-2 (Test Site ID: GCC_EMS-01)					
ESD Generator	TESEQ	NSG437	313	Sep. 07, 2018	
EN61000-4-3 (Test Site ID: GCC_EMS-02)					
RF Power Meter	BOONTON	4231A	110602	Jul. 18, 2018	
Signal Generator	R&S	SM300	101722	Jul. 13, 2018	
Electric Field probe	ETS-LINDGREN	HI-6005	29837	N/A	
Power Amplifier	SCHAFFNER	CBA9413B	4039	N/A	
Power Amplifier	TESEQ	CBA3G-050	T43752	N/A	
Switch Network	TESEQ	RFB2000	26336	N/A	
RF Power sensor	BOONTON	51011-EMC	33109	Jul. 18, 2018	
EN61000-4-4/ EN61000-4-5/ EN61000-4-8/ EN61000-4-11 (Test Site ID: GCC_EMS-03)					
EMC Immunity Test system	EMC PARTNERAG	TRA200IN6	739	Sep. 07, 2018	
Conducted disturbances generator	FRANKONIA	CIT10/75	102D3233	Sep. 25, 2018	
Induction Coil Interface	SCHAFFNER	2141	6019	Jul. 01, 2018	
TRIAxIAL ELF Magnetic Field Meter	SYPRIS	4090	4090070316	Jun. 02, 2018	
ANTENNA	EMC PARTNER AG	MF1000	117	Sep. 07, 2018	
EN61000-4-6 (Test Site ID: GCC_EMS-04)					
CDN	SCHAFFNER	CDN M316	20653	Nov. 09, 2018	
CDN	SCHAFFNER	CDN M216	19286	Nov. 09, 2018	
CDN	FRANKONIA	RJ45	60050134	Nov. 09, 2018	
6dB Attenuator	FRANKONIA	75-A-FFN-06	102D3233	N/A	
EM Injection Clamp	FCC	F-203I-23MM	471	Sep. 21, 2019	
Conducted disturbances generator	FRANKONIA	CIT10/75	102D3233	Sep. 25, 2018	

※ Calibration interval of instruments listed above is one year

2.3 TEST PERFORMED

Conducted emissions were investigated over the frequency range from 0.15MHz to 30MHz using a receiver which resolution bandwidth is set at 9 KHz.



Radiated emissions were investigated over the frequency range from 30MHz to 1000MHz using a receiver which resolution bandwidth is set at 120KHz. Radiated measurement was performed at distance that from an antenna to EUT is 10 meters.

2.4 APPENDIX

Appendix A: Measurement Procedure for Main Power Port Conducted Emissions

The measurements are performed in a Global lab's room; The EUT was placed on non-conductive 1.0m x 1.5m table, which is 0.8 meter above an earth-grounded.

Power to the EUT was provided through the LISN which has the Impedance (50ohm/50uH) vs. Frequency Characteristic in accordance with the standard. Power to the LISNs was filtered to eliminate ambient signal interference and these filters were bonded to the ground plane. Peripheral equipment required to provide a functional system (support equipment) for EUT testing was powered from the second LISN through a ganged, metal power outlet box which is bonded to the ground plane at the LISN.

If the EUT is supplied with a flexible power cord, the power cord length in excess of the distance separating the EUT from the LISN shall be folded back and forth at the center of the lead so as to form a bundle not exceeding 40cm in length. If the EUT is provided with a permanently coiled power cord, bundling of the cord is not required. If the EUT is supplied without a power cord, the EUT shall be connected to the LISN by a power cord of the type specified by the manufacturer which shall not be longer than 1 meter. The excess power cord shall be bundled as described above. If a non-flexible power cord is provided with the EUT, it shall be cut to the length necessary to attach the EUT to the LISN and shall not be bundled.

The interconnecting cables were arranged and moved to get the maximum measurement. Both the line of power cord and hot and neutral, was measured.

The highest emissions were analyzed in details by operating the spectrum analyzer in fixed tuned mode to determine the nature of the emissions and to provide information which could be useful in reducing their amplitude.

Appendix B: Test Procedure for Radiated Emissions

Preliminary Measurements in the Anechoic Chamber

The radiated emissions are initially measured in the anechoic chamber at a measurement distance of 3 meters. Desktop EUT are placed on a wooden stand 0.8 meter in height. The measurement antenna is 3 meters from the EUT. The test setup in anechoic chamber is the same as open site. The turntable rotated 360°. The antenna height is 1 meter. The primary objective of the radiated measurements in the anechoic chamber is to identify the frequency spectrum in the absence of the electromagnetic environment existing on the open test site. The frequencies can then be pre-selected on the open test site to obtain the corresponding amplitude. The initial scan is made with the spectrum analyzer in automatic sweep mode. The spectrum peaks are then measured manually to determine the exact frequencies.



Measurements on the Open Site or Chamber

The radiated emissions test will then be repeated on the open site or chamber to measure the amplitudes accurately and without the multiple reflections existing in the shielded room. The EUT and support equipments are set up on the turntable. Desktop EUT are set up on a wooden stand 0.8 meter above the ground.

For the initial measurements, the receiving antenna is varied from 1 to 4 meter height and is changed in the vertical plane from vertical to horizontal polarization at each frequency. Both reading are recorded with the quasi-peak detector with 120 KHz bandwidth. For frequency between 30 MHz and 1000MHz, the reading is recorded with peak detector or quasi-peak detector. For the frequency range is above 1 GHz, the EUT was positioned such that distance from antenna to the EUT is 3 meters. The bandwidth set on the field strength is 1 MHz when the frequency range is above 1GHz.

At the highest amplitudes observed, the EUT is rotated in the horizontal plane while changing the antenna polarization in the vertical plane to maximize the reading. The interconnecting cables were arranged and moved to get the maximum measurement. Once the maximum reading is obtained, the antenna elevation and polarization will be varied between specified limits to maximize the readings.

3. CONDUCTED EMISSION MEASUREMENT

3.1 TEST SETUP

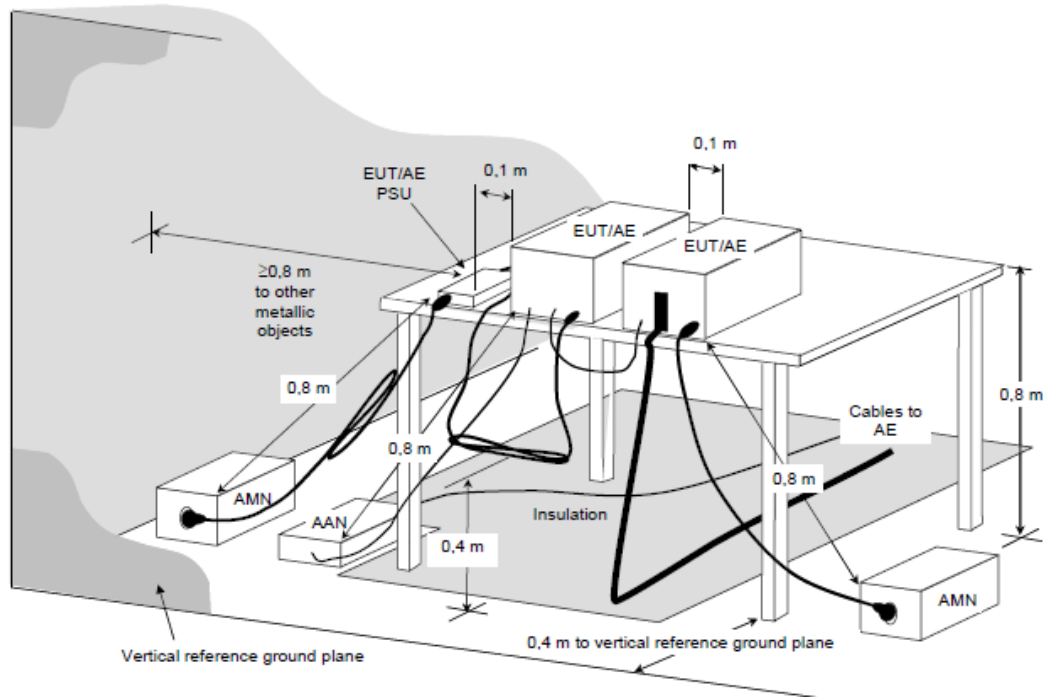

3.2 LIMIT

Frequency range (MHz)	CLASS A		CLASS B		Receiver RBW
	QP dB(uV)	Average dB(uV)	QP dB(uV)	Average dB(uV)	
0.15-0.5	79 dBuV	66 dBuV	66 - 56 dBuV	56 - 46 dBuV	9KHz
0.5-5.0	73 dBuV	60 dBuV	56 dBuV	46 dBuV	9KHz
5.0-30.0	73 dBuV	60 dBuV	60 dBuV	50 dBuV	9KHz

Remark: In the above table, the tighter limit applies at the band edges.

3.3 TEST PROCEDURE

The EUT and simulators are connected to the main power through a line impedance stabilization network (LISN). It provides a 50 ohm / 50 μH coupling impedance for the measuring equipment. The peripheral devices are also connected to the main power through a LISN that provides a 50 ohm / 50 μH coupling impedance with 50 ohm termination. (Please refer to the block diagram of the test setup and photograph.)

Both sides of AC line are checked for the maximum conducted emission interference. In order to find the maximum emissions, the relating positions of equipment and all of the interference cables must be changed according to EN55032 regulations: The measurement procedure on conducted emission interference.

The resolution bandwidth of the field strength meter is set at 9 KHz.



3.4 TEST SPECIFICATION

According to EN55032 Class B

(Please refer to Page 4 for dated references which are related to the standard as mentioned above)

3.5 TEST DATA:

Please refer to appendix 2.

3.6 RESULT:

PASS

3.7 LIMIT OF CONDUCTED COMMON MODE DISTURBANCE AT TELECOMMUNICATION PORTS:

Frequency Range MHz	Class A		Class B		Receiver RBW
	Quasi Peak (dBuV)	Average	Quasi Peak (dBuV)	Average	
0.15 ~ 0.5	97 - 87	84 - 74	84 - 74	74 - 64	9KHz
0.5 ~ 30	87	74	74	64	9KHz

The limits decrease linearly with the logarithm of the frequency in the range 0.15 MHz to 0.5MHz.

Remark:

1. Measuring highest data rate mode: ①LAN1 Link 10M ②LAN1 Link 100M
③ LAN2 Link 10M ④ LAN2 Link 100M
2. The Worst Mode: ②LAN1 Link 100M
3. Deviations from the test standards and rules: None.
4. “*” , means this data is peak measuring as peak value is under Q.P. Limit or Average Limit 3dB margin.

3.8 TEST DATA:

Please refer to appendix 2.

3.9 RESULT:

PASS

4. RADIATED EMISSION MEASUREMENT

4.1 TEST SETUP

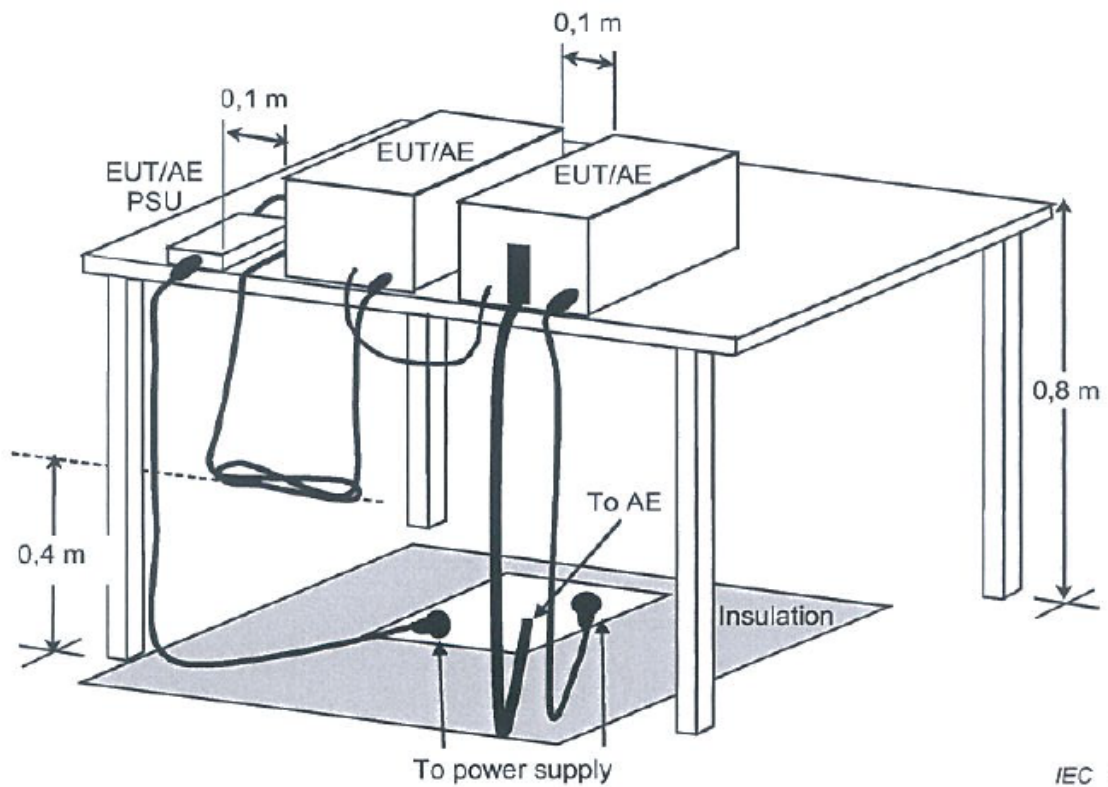

Below 1GHz

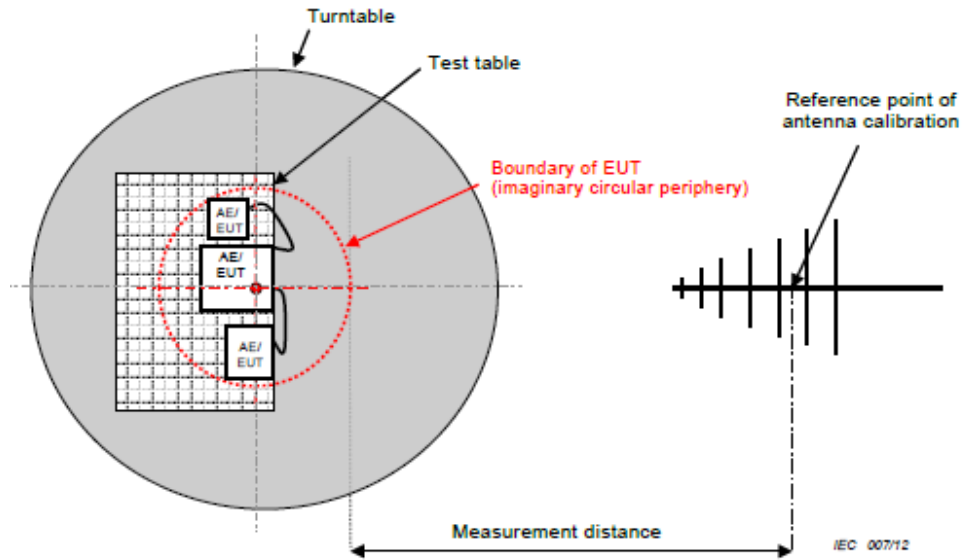

Above 1GHz

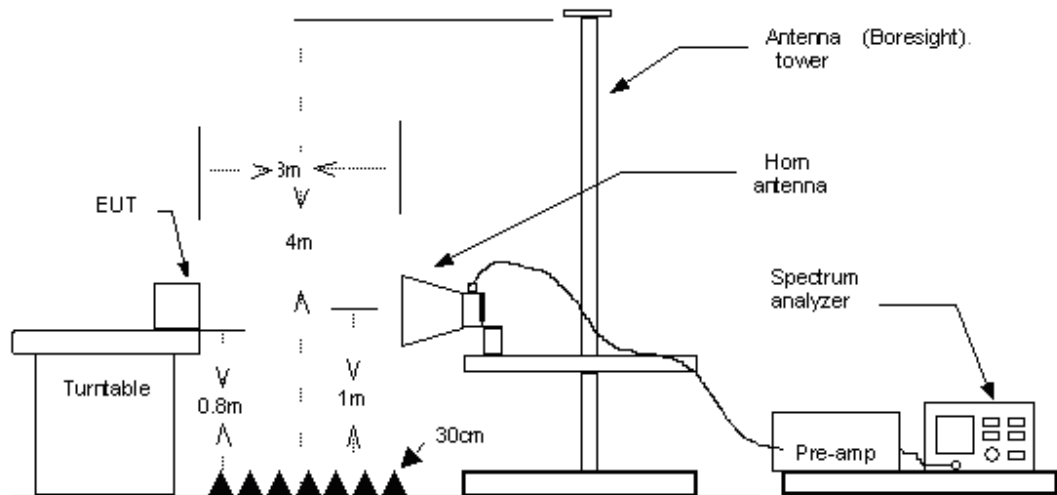



4.2 LIMIT

Frequency	Class A		Class B		Receiver RBW
MHz	Distance (Meter)	Limit dB μ V/m	Distance (Meter)	Limit dB μ V/m	
30 ~ 230	10	40	10	30	120KHz
	3	50	3	40	
230 ~ 1000	10	47	10	37	120KHz
	3	57	3	47	

Frequency range GHz	Class A		Class B		Receiver RBW
	Average limit dB(μ V/m)	Peak limit dB(μ V/m)	Average limit dB(μ V/m)	Peak limit dB(μ V/m)	
1 to 3	56	76	50	70	1MHz
3 to 6	60	80	54	74	1MHz

NOTE The lower limit applies at the transition frequency.

Remark: In the above table, the tighter limit applies at the band edges

Radiated emissions from FM receivers

Frequency range MHz	Measurement		Class B limit dB(μ V/m)		
	Distance m	Detectortype / bandwidth	Fundamental	Harmonics	
			OATS / SAC (see Table A.1)	OATS / SAC (see Table A.1)	
30 – 230	10	Quasi peak/ 120kHz	50	42	
230 – 300				42	
300 – 1000				46	
30 – 230	3		Quasi peak/ 120kHz	60	52
230 – 300					52
300 – 1000					56

These relaxed limits apply only to emissions at the fundamental and harmonic frequencies of the local oscillator. Signals at all other frequencies shall be compliant with the limits given in 7.3.1 Class B Limit



4.3 TEST PROCEDURE

The EUT and its simulators are placed on turn table, non-conductive and wooden table, which is 0.8 meter above ground. The turn table rotates 360 degrees to determine the position of the maximum emission level. The EUT was positioned such that distance from antenna to the EUT is 10 meters(OATS) or 3 meters(SAC). For the frequency range is above 1 GHz, the EUT was positioned such that distance from antenna to the EUT is 3 meters.

The antenna is moved up and down between 1 meter and 4 meters to receive the maximum emission level.

Both horizontal and vertical polarizations of the antenna are set on measurement. In order to find the maximum emission, all of the interference cables must be manipulated according to EN55032 regulations: the test procedure of the radiated emission measurement.

The bandwidth set on the field strength is 120 KHz when the frequency range is below 1GHz. The bandwidth set on the field strength is 1 MHz when the frequency range is above 1GHz.

4.4 TEST SPECIFICATION

According to EN55032 Class B

(Please refer to Page 4 for dated references which are related to the standard as mentioned above)

4.5 TEST DATA:

Please refer to appendix 2.

4.6 RESULT:

PASS



5. CONDUCTED DIFFERENTIAL VOLTAGE EMISSIONS MEASUREMENT

5.1 TEST SETUP

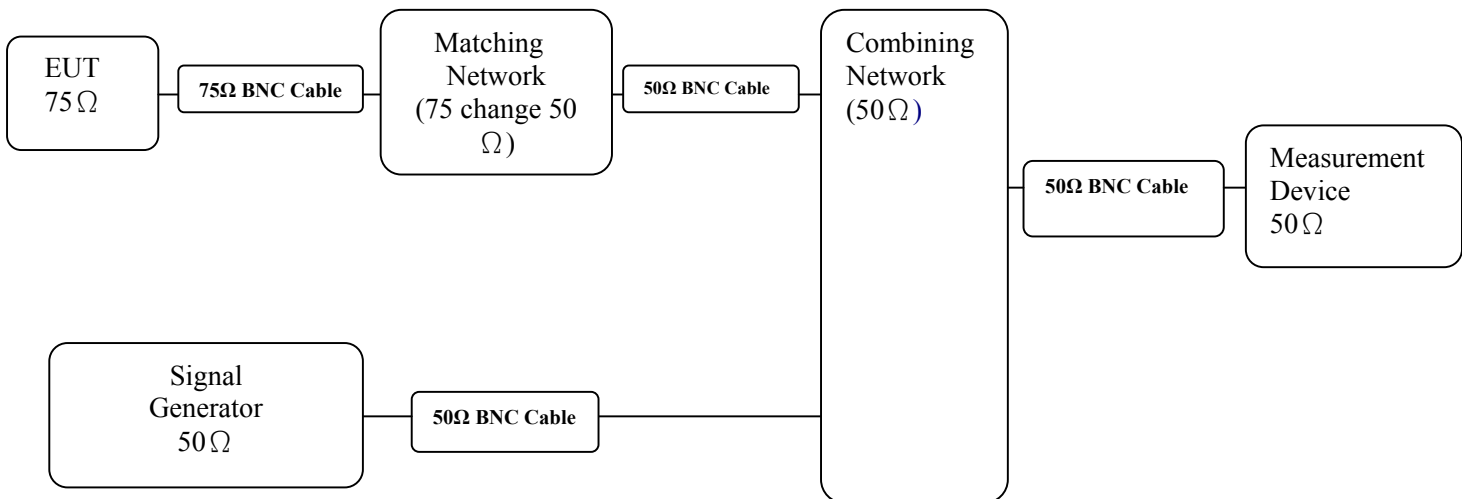



5.2 LIMIT

Applicable to				
1. TV broadcast receiver tuner ports with an accessible connector				
2. RF modulator output ports				
3. FM broadcast receiver tuner ports with an accessible connector				
Frequency range MHz	Class B limits dB(μV) 75 Ω			Applicability
	other	Local Oscillator Fundamental	Local Oscillator Harmonics	
30 – 950	46	46	46	See a)
950 – 2 150	46	54	54	
950 – 2 150	46	54	54	See b)
30 – 300	46	54	50	See c)
300 – 1 000			52	
30 – 300	46	66	59	See d)
300 – 1 000			52	
30 – 950	46	76	46	See e)
950 – 2 150		n/a	54	

a) Television receivers (analogue or digital), video recorders and PC TV broadcast receiver tuner cards working in channels between 30 MHz and 1 GHz, and digital audio receivers.

b) Tuner units (not the LNB) for satellite signal reception.

c) Frequency modulation audio receivers and PC tuner cards.

d) Frequency modulation car radios.

e) Applicable to EUTs with RF modulator output ports (for example DVD equipment, video recorders, camcorders and decoders etc.) designed to connect to TV broadcast receiver tuner ports.

Testing is required at only one EUT supply voltage and frequency.

The term 'other' refers to all emissions other than the fundamental and the harmonics of the local oscillator.

The test shall be performed with the device operating at each reception channel.

The test shall cover the entire frequency range.



5.3 TEST PROCEDURE

Procedure of Preliminary Test

- The equipment was set up as per the test configuration to simulate typical usage per the user's manual. The EUT was placed on a wooden table with a height of 0.8 meters was used that was placed on the ground plane.
- Support equipment, if needed, was placed as per EN 55032.
- All I/O cables were positioned to simulate typical usage as per EN 55032.
- The EUT received AC power source, from the outlet socket. All support equipment received power was from another socket.
- Added a $75\Omega \rightarrow 50\Omega$ matching network, between EUT and EMI test receiver to get impedance match condition during the test.
- The output level of the auxiliary signal generator shall be set to give the value of 60 dB (μV) for FM receiver or 70 dB (μV) for TV and VCR to the input of the frequency-modulation or television receiver (or video recorder) respectively, on a 75Ω impedance. An additional amplifier should be insert at the generator output, if necessary.
- The output level of the auxiliary signal generator shall be a standard TV color bar Move signal for TV receivers and video recorders with sound carrier that defined in Table A12 of EN 55032 .An additional amplifier should be insert at the generator output, if necessary.
- The results shall be expressed in the terms of the substitution voltage in decibels (μV), as supplied by the standard signal generator. The specified source impedance of the receiver shall be stated with the results.
- When measurements are made at the antenna terminals of the EUT, an auxiliary signal generator shall be used to feed the equipment under test input with a standard test signal (see Table A.12 of CISPR 32/ EN 55032) at the receiver tuning frequency (30MHz to 2150MHz).
- The test mode(s) described in Item 4.1 were scanned during the preliminary test:
- After the preliminary scan, we found the test mode described in Item 4.1 producing the highest emission level.

Procedure of Final Test

- EUT and support equipment were set up on the table as per the configuration with highest emission level in the preliminary test.
- The Analyzer / Receiver scanned from 30MHz to 2150MHz. recorded the value, the local frequency, amplitude, were recorded in which correction factors were used to calculate the emission level and compare reading to the applicable limit, and only Q.P reading will record in this report.
- Recorded at least the six highest emissions. Emission frequencies, amplitude were recorded into a computer in which correction factors were used to calculate the emission level and compare reading to the applicable limit and only Q.P. reading is presented.
- The test data of the worst-case condition(s) was recorded.



5.4 TEST SPECIFICATION

According to EN55032 Class B
(Please refer to Page 4 for dated references which are related to the standard as mentioned above)

5.5 TEST DATA :

N/A

5.6 RESULT:

No applicable, because the EUT doesn't have TV, FM and RF modulator I/O ports.

6. HARMONIC CURRENT EMISSIONS MEASUREMENT

6.1 TEST SETUP

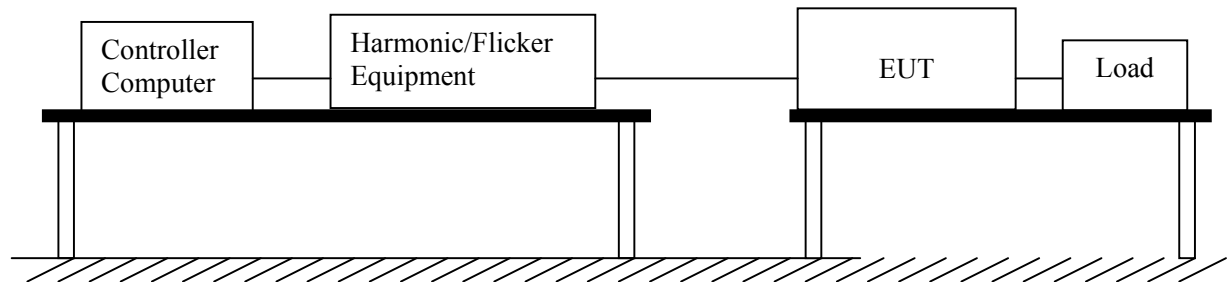

6.2 LIMIT OF HARMONIC CURRENT

Limit of Harmonic Currents

Harmonic Order	Maximum Permissible Harmonic Current (Ampere)	Harmonic Order	Maximum Permissible Harmonic Current (Ampere)
Odd Harmonic		Even Harmonic	
3	2.30	2	1.08
5	1.14	4	0.43
7	0.77	6	0.30
9	0.40	8 ≤ n ≤ 40	0.23 x 8/n
11	0.33		
13	0.21		
15 ≤ n ≤ 39	0.15 x 15/n		

6.3 TEST PROCEDURE

The EUT is supplied in series with power analyzer from a power source has the same normal voltage and frequency as the rated supply voltage and the equipment under test.

6.4 TEST SPECIFICATION

According to EN61000-3-2

(Please refer to Page 4 for dated references which are related to the standard as mentioned above)

6.5 TEST DATA:

Please refer to appendix 2.

6.6 RESULT:

PASS

7. VOLTAGE FLUCTUATIONS

7.1 TEST SETUP

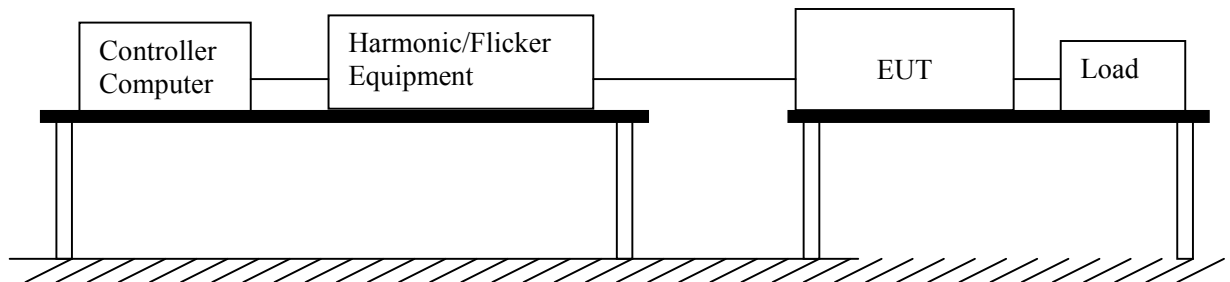

7.2 VOLTAGE FLUCTUATIONS TEST

Port:	AC mains
Basic Standard:	EN61000-3-3
Test Procedure	Refer to paragraph 6.3
Observation period:	For Pst 10min
	For Plt 2 hours

7.3 TEST PROCEDURE

The EUT is supplied in series with reference impedance from a power source with the voltage and frequency as the nominal supply voltage and frequency of the EUT.

7.4 TEST SPECIFICATION

EN61000-3-3

(Please refer to Page 4 for dated references which are related to the standard as mentioned above)

7.5 TEST DATA:

Please refer to appendix 2.

7.6 RESULT:

PASS

8. ELECTROSTATIC DISCHARGE IMMUNITY TEST (ESD)

8.1 TEST SPECIFICATION

Test is carried out according to EN61000-4-2, and the Test Level is subject to Table 1 of EN 55024. (Please refer to Page 4 for dated references which are related to the standard as mentioned above)

8.2 TEST SETUP

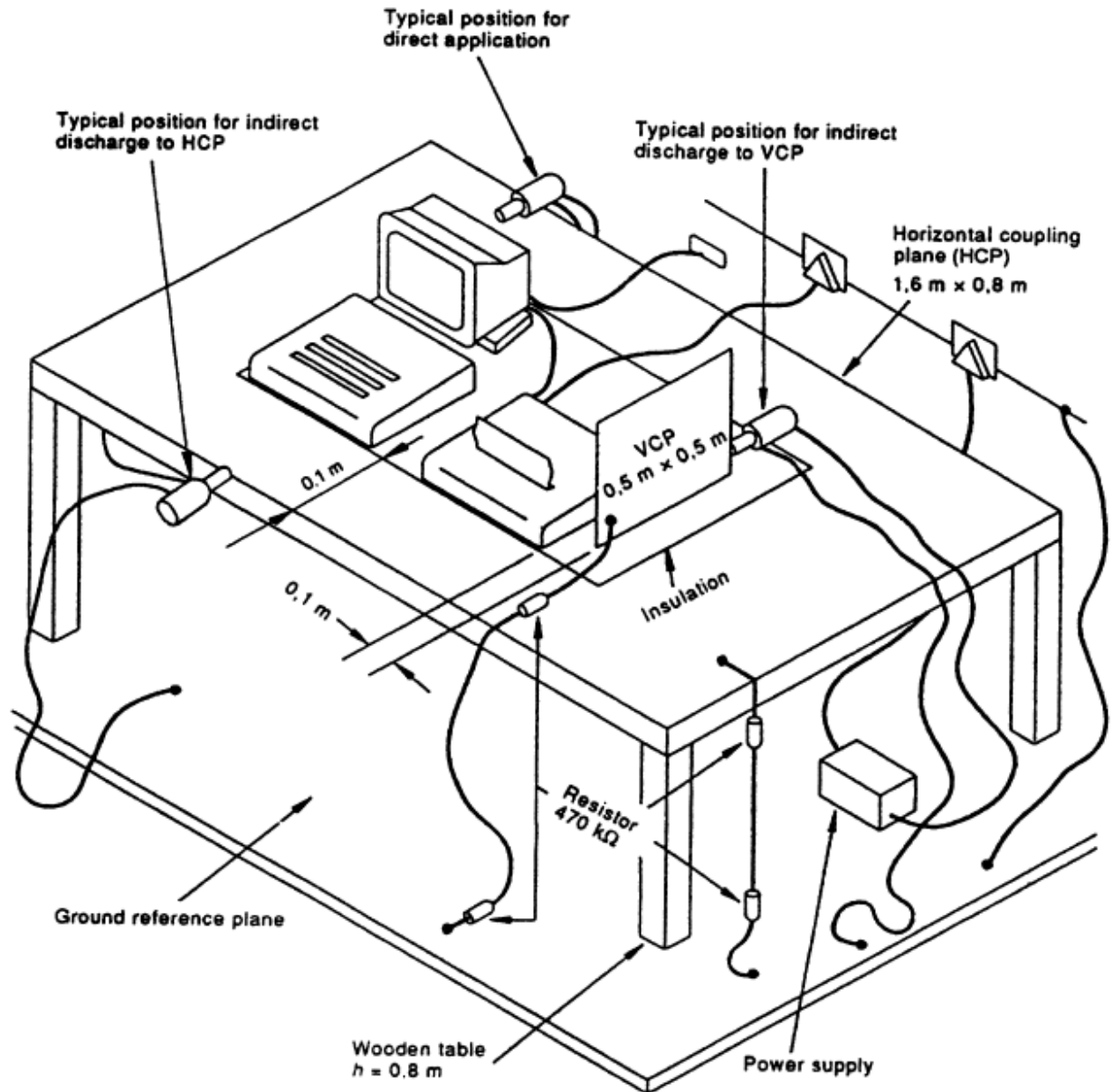

8.3 TEST LEVEL

Item	Test Specification	Unit	Performance Criteria
------	--------------------	------	----------------------



Enclosure Room	±2, 4, 8 (Air Discharge)	KV (Charge Voltage)	B
Electrostatic Discharge	±2,4 (Contact Discharge)		
Time between test	<u>1</u>	sec	

Number of test: 10 Discharges / Test point / Polarity / Level

Particular requirements: at least 200 discharges, 100 each at negative and positive polarity, at a minimum of four test points.

When the measurement was taken, The ESD discharger was performed in single discharge. For the single discharge time between successive single discharges will keep on one second. It was at least ten single discharges with positive and negative at the same selected pointed. The selected pointed, which was performed with electrostatic discharge, was marked on the red label on the EUT

Indirect applicant of discharge to the EUT

Vertical Coupling Plane (VCP)

The coupling plane, of dimensions 0.5m x 0.5m, is placed parallel to, and positioned at a distance 0.1m from, the EUT, with the discharge electrode touching the coupling plane.

The four faces of the EUT will be performed with electrostatic discharge. It was at least ten singles discharges with positive and negative at the same selected point.

Horizontal Coupling Plane (HCP)

The coupling plane is placed under the EUT. The generator shall be positioned vertically at a distance of 0.1m from the EUT, with the discharge electrode touching the coupling.

The four faces of the EUT will be performed with electrostatic discharge. It was at least ten single discharges with positive and negative at the same selected pointed.

8.4 TEST RESULT

Model: NP-2160

Temperature: 25°C , Humidity: 50 % RH

Test Point	Air Discharge	Contact Discharge	Performance Criteria	Result
HCP	----	±2, 4KV	A	PASS
VCP	----	±2, 4KV	A	PASS
CASE	----	±2, 4KV	B	PASS
Screws	----	±2, 4KV	B	PASS
DC Jack	----	±2, 4KV	B	PASS
VGA	----	±2, 4KV	B	PASS
LAN	----	±2, 4KV	B	PASS
USB	----	±2, 4KV	B	PASS
RS-232	----	±2, 4KV	B	PASS

Button	----	±2, 4KV	B	PASS
HDMI	±2, 4, 8KV	----	A	PASS
Audio	±2, 4, 8KV	----	A	PASS
IR	±2, 4, 8KV	----	A	PASS
eSATA	±2, 4, 8KV	----	A	PASS
LED	±2, 4, 8KV	----	A	PASS
Reset	±2, 4, 8KV	----	A	PASS

Note 1 : Test Points please see the arrows of below photos.

Note 2 : Red Dot: Contact / Blue Dot: Air







Final Result: **PASS**

Remark: *The EUT was influenced during the test, but it returned to normal after the test.*

Photos of test configuration please refer to appendix 1.

9. RADIATED SUSCEPTIBILITY MEASUREMENT (RS)

9.1 TEST SETUP

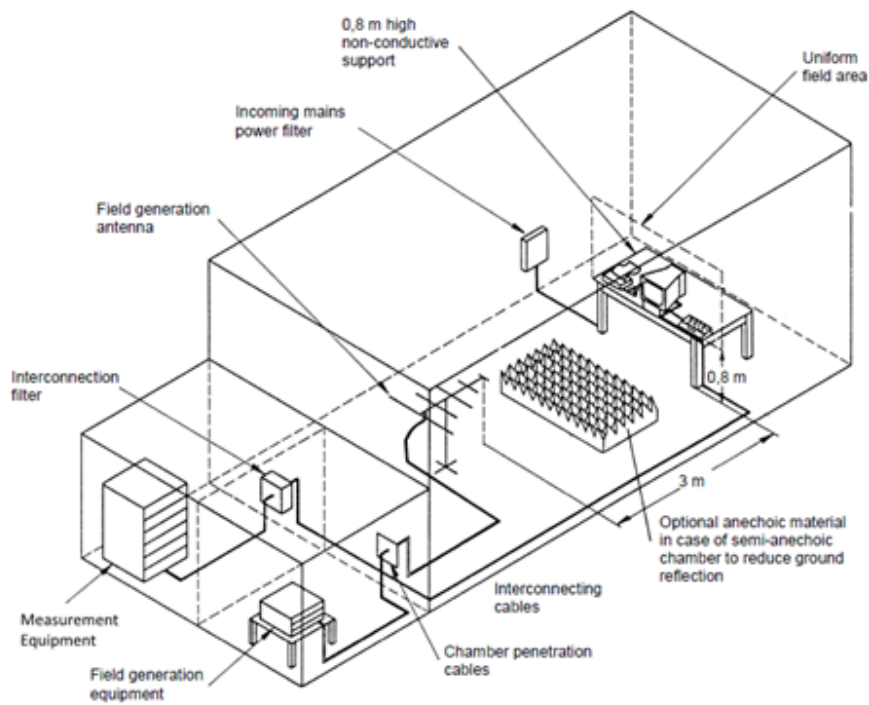

9.2 TEST SPECIFICATION

Test is carried out according to EN61000-4-3, and the Test Level is subject to Table 1 of EN 55024. (Please refer to Page 4 for dated references which are related to the standard as mentioned above)

9.3 TEST LEVEL

Item	Test Specification	Unit	Performance Criteria
Radio –Frequency	80~1000	MHz	A
Electromagnetic Field	3	V/m (unmodulated, rms)	
Amplitude Modulated	80	%AM (1KHz)	



9.4 TEST PROCEDURE

The EUT and load, which are placed on a wooden table whose height is 0.8 meter above ground, are placed with one coincident with the calibration plane such that the distance from antenna to the EUT is 3 meters.

Both horizontal and vertical polarization of the antenna position and four sides of the EUT are set on measurement. In order to judge the EUT performance, a CCD camera is used to monitor the situation of EUT.

All the scanning conditions are as follows:

Condition of Test	Remarks
1. Field Strength	3 V/m; Level 2
2. Radiated Signal	AM 80% modulated with 1KHz
3. Scanning Frequencies	80MHz ~ 1000MHz
4. Dwell Time	3 seconds
5. Frequency step size	1%
6. The rate of swept of frequency	1.5×10^{-3} decades/s
7. Antenna Polarity	HORIZONTAL & VERTICAL
8. The four sides of EUT are tested	FRONT, REAR, RIGHT, LEFT

9.5 TEST RESULT

Model: NP-2160

Temperature: 25°C , Humidity: 50 % RH

ANT SIDE	3V HORIZONTAL	3V VERTICAL	RESULT
FRONT	A	A	PASS
REAR	A	A	PASS
RIGHT	A	A	PASS
LEFT	A	A	PASS

Note: A means criteria A.

Final Result: **PASS**

Remark:

Photos of test configuration please refer to appendix 1.

10. ELECTRICAL FAST TRANSIENT/BURST (EFT)

10.1 TEST SETUP

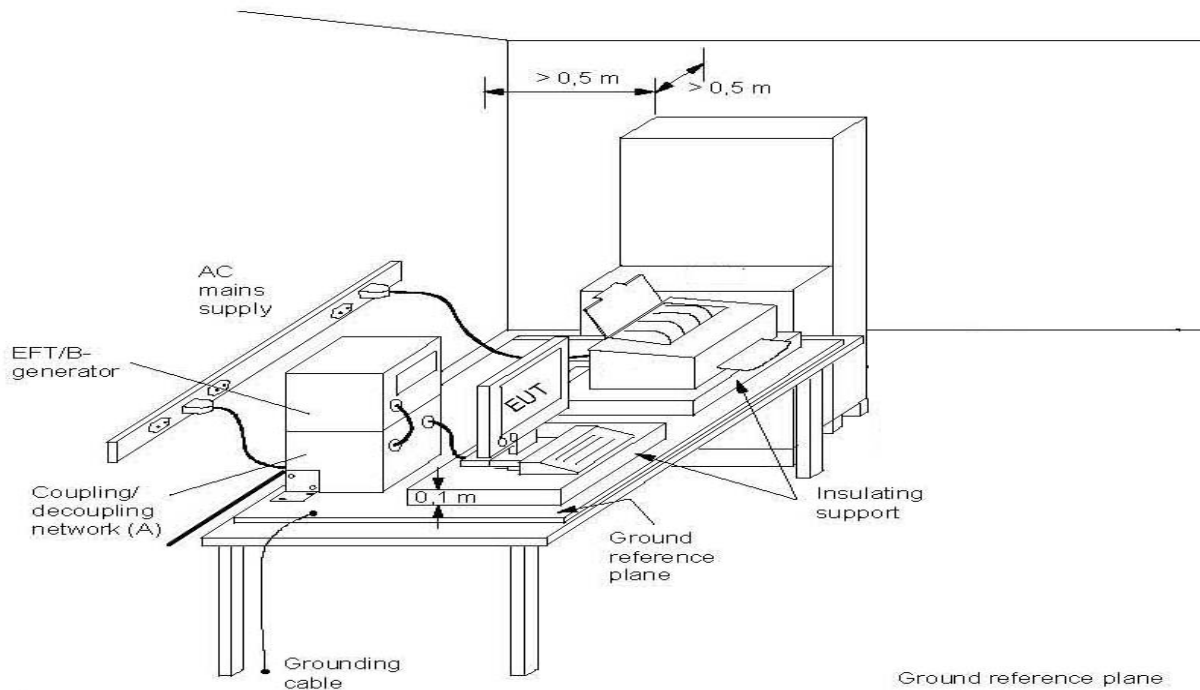

10.2 TEST SPECIFICATION

Test is carried out according to EN61000-4-4, and the Test Level is subject to Table 1 of EN 55024 (Please refer to Page 4 for dated references which are related to the standard as mentioned above)

10.3 TEST PROCEDURE

The EUT and load are placed on a ground reference plane and insulated from it by an insulating support $0,1 \text{ m} \pm 0,01 \text{ m}$ thick. The minimum area of the ground reference plane is $1 \text{ m} \times 1 \text{ m}$. It also projected beyond the EUT by at least 0.1meter on all sides.

For Input and Output AC power or DC Input and DC Output Power Ports:

The EUT is connected with the power mains through a coupling device that directly couples the EFT interference signal.

Each of the line and nature conductors is impressed with burst noise for 1 minute.

For Protective Earth Port:

The EUT is connected to the power mains through a coupling device that directly couples the EFT interference signal. The protective earth line (PE) is impressed with burst noise for 1 minute.

The length of power cord between the coupling device and the EUT shall be $0.5 \text{ m} \pm 0.05 \text{ m}$.

For signal Lines and Control Lines Test:

The EFT interference signal is through a coupling clamp device couples to the signal and control lines of the EUT with burst noise for 1 minute.



10.4 TEST LEVEL

Item	Test Specification		Unit	Performance Criteria
Test Voltage	AC Input Power Line	±0.5, ±1	KV (Peak)	B
	DC Input Power Line	±0.5		
	Signal & Telecommunication Port	±0.25, ±0.5		
Pulse Rise time & Duration	5/50		Tr/Ts (ns)	
Pulse Repetition	5		Rep. Frequency (KHz)	
Coupling of power line	L, N, PE, L+N, L+PE, N+PE, L+N+PE			

10.5 TEST RESULT

Model: NP-2160

Temperature: 25°C , Humidity: 50 % RH

Power Line							
TEST VOLTAGE	L	N	PE	L+N	L+PE	N+PE	L+N+PE
±0.5KV	A	A	A	A	A	A	A
±1KV	A	A	A	A	A	A	A

Note: A means criteria A.

Signal Control Line	
TEST VOLTAGE	Performance Criteria
±0.25KV	A
±0.5KV	A

Note: A means criteria A.

Final Result:

PASS

Remark:

Photos of test configuration please refer to appendix 1.

11. SURGE

11.1 TEST SETUP

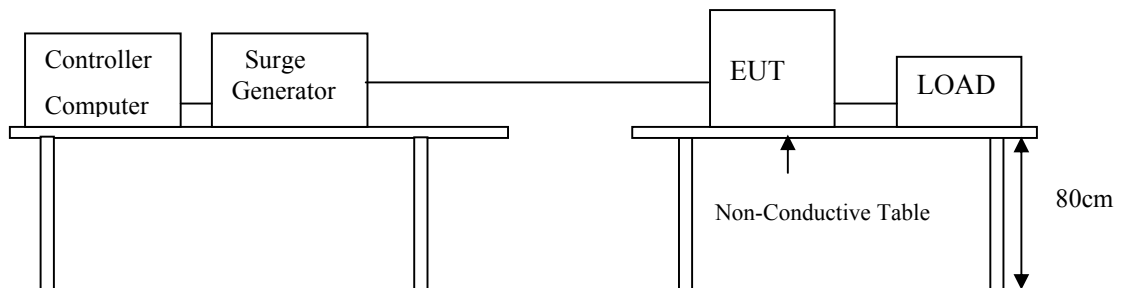

11.2 TEST SPECIFICATION

Test is carried out according to EN61000-4-5, and the Test Level is subject to Table 1 of EN 55024 (Please refer to Page 4 for dated references which are related to the standard as mentioned above)

11.3 TEST LEVEL

Item	Test Specification	Unit	Performance Criteria
DC Input and DC Output Power Ports			
Surge	1.2/50(8/20)	Tr/Ts (µs)	B
Line to Ground	±0.5	KV	
Line to Line	±0.5	KV	
Polarity	POSITIVE / NEGATIVE		

Item	Test Specification	Unit	Performance Criteria
AC Input and AC Output Power Ports			
Surge	1.2/50(8/20)	Tr/Ts (µs)	B
Line to Ground	±2	KV	
Line to Line	±1	KV	
Polarity	POSITIVE / NEGATIVE		
Phase shifting in a range between 0° to 360°			



Item	Test Specification	Unit	Performance Criteria
Signal & Telecommunication Port			
Surge	10/700	Tr/Ts (µs)	C
Line to Ground	±1	KV	
Line to Ground	±4	KV	
Polarity	POSITIVE / NEGATIVE		
For ports where primary protection is intended, surges are applied at voltages up to 4kV with the primary protectors fitted. Otherwise the 1kV test level is applied without primary protection in place.			

11.4 TEST PROCEDURE

The EUT and its load are placed on a table which is 0.8 meter height. The length of power cord between the coupling device and the EUT shall be 2 meters or less.

For Input and Output AC Power or DC Input and DC Output Power Ports:

The EUT is connected to the power mains through a coupling device that directly couples the Surge interference signal.

The Surge noise shall be applied synchronized to the voltage phase at 0°, 90°, 180°, 270° and the peak value of the AC voltage wave. (5 Positive and 5 Negative)

Each of line-earth and line-line is impressed with a sequence of five surge voltages with interval of 1 minute.

11.5 TEST RESULT

Model: NP-2160

Temperature: 25°C , Humidity: 50 % RH

AC Power Port

Environmental Phenomena	Test Specification	Units	Performance Criteria
Line to Line	±1	KV (Charge Voltage)	A
Line to Ground	±2	KV (Charge Voltage)	A

Final Result:

PASS

Remark:

Photos of test configuration please refer to appendix 1.

12. IMMUNITY TEST TO CS CONDUCTED DISTURBANCE (CS)

12.1 TEST SETUP

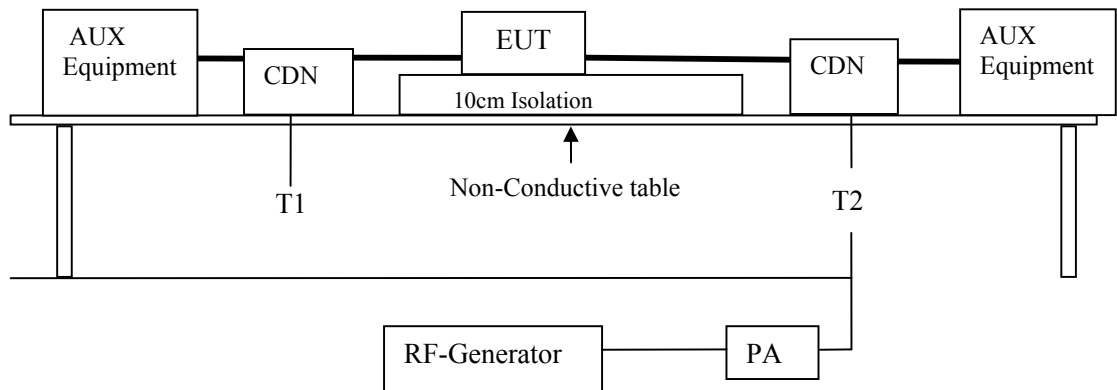

12.2 TEST SPECIFICATION

Test is carried out according to EN61000-4-6, and the Test Level is subject to Table 1 of EN 55024. (Please refer to Page 4 for dated references which are related to the standard as mentioned above)

12.3 TEST LEVEL

Item	Test Specification	Unit	Performance Criteria
Ports for Signal Lines			
Radio-Frequency	0.15 ~ 80	MHz	A
Common Mode	3	V (rms, Unmodulated)	
Amplitude Modulated	80	%AM (1KHz)	
	150	Source Impedance	
Ac Input and AC Output and DC Input and DC output Ports and Functional Earth Ports			
Radio-Frequency	0.15 ~ 80	MHz	
Common Mode	3	V (rms, Unmodulated)	A
Amplitude Modulated	80	%AM (1KHz)	
	150	Source Impedance	



12.4 TEST PROCEDURE

The EUT are placed on a table which is 0.8 meter height and a ground reference plane on the table, the EUT are placed upon table and use 10cm insulation between the EUT and ground reference plane.

For AC Input and AC Output Power or DC Input and DC Output Power Ports

The EUT is connected to the power mains through a coupling and decoupling networks for Power supply lines. It also directly couples the disturbance signal into EUT.

Use CDN-M2 for two wires or CDN-M3 for three wires.

For Signal Lines and Control Lines Test:

The disturbance signal is through a coupling and decoupling networks (CDN) or EM-clamp which is to couple the signal and control lines of the EUT.

All scanning frequencies conditions are as following:

Condition of Test	Remarks
EN61000-4-6	
1. Field Strength	3 V; Level 2
2. Radiated Signal	AM 80% modulated with 1KHz
3. Scanning Frequencies	0.15MHz ~ 80MHz
4. Dwell Time	3 seconds
5. Frequency step size Δf	1%
6. The rate of swept of frequency	1.5×10^{-3} decades/s

12.5 TEST RESULT

Model: NP-2160

Temperature: 25°C , Humidity: 50 % RH

Power and Signal

TEST Specification	Unit	Performance Criteria
0.15 - 80	MHz	A
3	V	
80	% AM (1KHz)	

Final Result:

PASS

Remark:

Photos of test configuration please refer to appendix 1.

13. POWER FREQUENCY MAGNETIC FIELD (MAGNETIC)

13.1 TEST SETUP

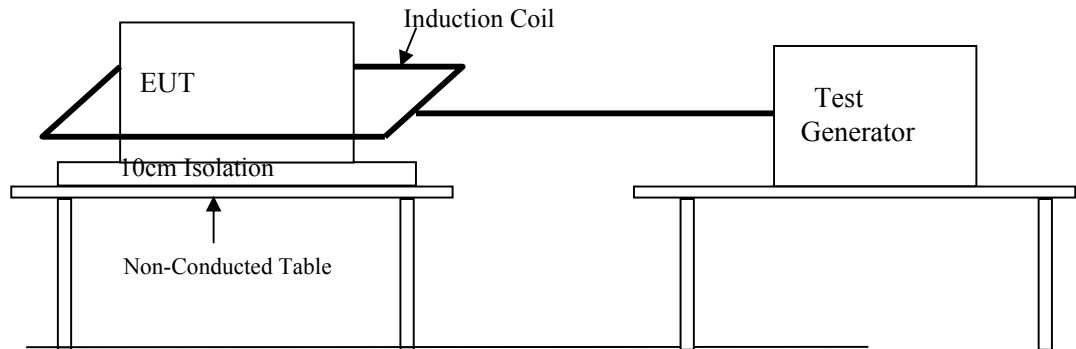

13.2 TEST SPECIFICATION

Test is carried out according to EN61000-4-8, and the Test Level is subject to Table 1 of EN 55024 (Please refer to Page 4 for dated references which are related to the standard as mentioned above)

13.3 TEST LEVEL

Item	Test Specification	Unit	Performance Criteria
Power-Frequency	50	Hz	A
Magnetic Field	1	A/m	

13.4 TEST PROCEDURE

The EUT and its load are placed on a table that is 0.8 meter above the metal ground plane dimension is at least 1 meter x 1 meter. The test magnetic field shall be placed at least than 3 meter distance from the induction coil.

The test magnetic field shall be applied by the immersion method to the EUT. The induction coil shall be rotated by 90° in order to expose the EUT to the test field with different orientation (X, Y, Z orientation).



13.5 TEST RESULT

Model: NP-2160

Temperature: 25°C , Humidity: 50 % RH

Environmental Phenomena	Test Specification	Units	Performance Criteria
Magnetic Field	1	A/m	A

Final Result:

PASS

Remark:

Photos of test configuration please refer to appendix 1.

14. VOLTAGE DIPS AND INTERRUPTION MEASUREMENT

14.1 TEST SETUP

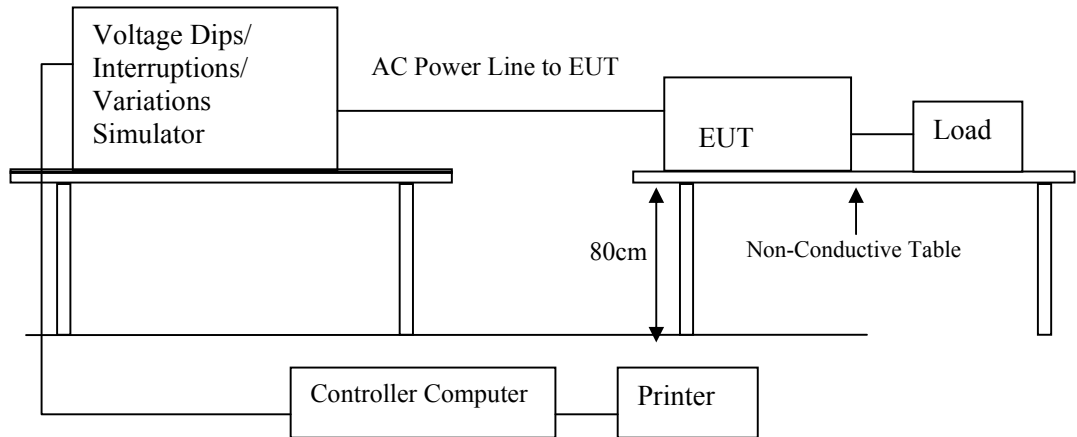

14.2 TEST SPECIFICATION

Test is carried out according to EN61000-4-11, and the Test Level is subject to Table 1 of EN 55024. (Please refer to Page 4 for dated references which are related to the standard as mentioned above)



14.3 TEST LEVEL

Class ^a	Test level and durations for voltage dips				
Class 1	Case-by-case according to the equipment requirements				
Class 2	0 % during 1/2 cycle	0 % during 1 cycle	70 % during 25/30 ^c cycles		
Class 3	0 % during 1/2 cycle	0 % during 1 cycle	40 % during 10/12 ^c cycles	70 % during 25/30 ^c cycles	80 % during 250/300 ^c cycles
Class X ^b	X	X	X	X	X

a: Classes as per EN61000-2-4.
b: To be defined by product committee. For equipment connected directly or indirectly to the public network, the levels must not be less severe than Class 2.
c: “25/30 cycles” means “25 cycles for 50 Hz test” and “30 cycles for 60 Hz tet”.

Class ^a	Test level and durations for short interruptions (t _s) (50Hz / 60Hz)
Class 1	Case-by-case according to the equipment requirements
Class 2	0 % during 250/300 ^c cycles
Class 3	0 % during 250/300 ^c cycles
Class X ^b	X

a: Classes as per EN61000-2-4.
b: To be defined by product committee. For equipment connected directly or indirectly to the public network, the levels must not be less severe than Class 2.
c: “250/300 cycles” means “250 cycles for 50 Hz test” and “300 cycles for 60 Hz test”.

14.4 TEST PROCEDURE

The EUT and its load are placed on a wooden table which is 0.8 meter above a metal ground plane which dimension is 1 meter x 1 meter, the thickness is 0.65mm. It projected beyond the EUT by at least 0.1 meter on all sides. The power cord shall be used the shortest power cord as specified by the manufacturer.

For Voltage Dips / Interruption Test:

The EUT is connected to the power mains through a coupling device that directly couples to the Voltage Dips and Interruption Generator.

The EUT shall be tested for 30% voltage dips of supplied voltage and duration time is 10ms, for 60% voltage dips of supplied voltage and duration time is 100ms with a sequence of three voltage dips with intervals of 10 seconds, and for 95% voltage interruption of supplied voltage and the duration time is 5000ms with a sequence of three voltage interruptions with intervals of 10 seconds.

Voltage phase shifting are shall occur at 0°, 45°, 90°, 135°, 180°, 225°, 270°, 315° of the voltage.



14.5 TEST RESULT

Model: NP-2160

Temperature: 25°C , Humidity: 50 % RH

Voltage Dips	Test Level % U _T	Reduction (%)	Duration	Performance Criteria
	<5	>95	0.5 (periods)	A
	70	30	25 (periods)	A
Voltage Interruptions	Test Level % U _T	Reduction (%)	Duration	Performance Criteria
	<5	>95	250(periods) 5000ms	B

Final Result:

PASS

Remark: *The EUT was influenced during the test, but it returned to normal after the test.*

Photos of test configuration please refer to appendix 1.



15. PERFORMANCE CRITERIA

- A. During and after the test the EUT shall continue to operate as intended without operator intervention. No degradation of performance or loss of function is allowed below a minimum performance level specified by the manufacturer when the EUT is used as intended. The performance level may be replaced by a permissible loss of performance. If the minimum performance level or the permissible performance loss is not specified by the manufacturer, then either of these may be derived from the product description and documentation, and by what the user may reasonably expect from the EUT if used as intended.
- B. After the test, the EUT shall continue to operate as intended without operator intervention. No degradation of performance or loss of function is allowed, after the application of the phenomena below a performance level specified by the manufacturer, when the EUT is used as intended. The performance level may be replaced by a permissible loss of performance. During the test, degradation of performance is allowed. However, no change of operating state or stored data is allowed to persist after the test. If the minimum performance level (or the permissible performance loss) is not specified by the manufacturer, then either of these may be derived from the product description and documentation, and by what the user may reasonably expect from the EUT if used as intended.
- C. During and after testing, a temporary loss of function is allowed, provided the function is self-recoverable, or can be restored by the operation of the controls or cycling of the power to the EUT by the user in accordance with the manufacturer's instructions. Functions, and/or information stored in non-volatile memory, or protected by a battery backup, shall not be lost.



16. EMC MODIFICATION & ESTIMATED MEASUREMENT UNCERTAINTY

16.1 EMC MODIFICATION

No additional EMC solution was made during the Compliance testing.

16.2 ESTIMATED MEASUREMENT UNCERTAINTY

The estimated measurement uncertainty is calculated in accordance with CISPR16-4-2, the total uncertainty for this test is listed as below:

Uncertainty of Conducted Emission Measurement (9KHz~30MHz)

Contribution	Probability Distribution	9KHz – 30MHz
Measuring uncertainty for a level of confidence of 95% $U=2Ue(y)$	Normal (k=2)	± 3.2 dB

Uncertainty of Conducted Emission Measurement (150KHz~30MHz) ISN T8

Contribution	Probability Distribution	150KHz – 30MHz
Measuring uncertainty for a level of confidence of 95% $U=2Ue(y)$	normal (k=2)	± 3.9 dB

Uncertainty of Radiated Emission Measurement (30MHz~1GHz)

Contribution	Probability Distribution	30MHz~1GHz
Measuring uncertainty for a level of confidence of 95% $U=2Ue(y)$	Normal (k=2)	± 2.7 dB

Uncertainty of Radiated Emission Measurement (1GHz~18GHz)

Contribution	Probability Distribution	1GHz~18GHz
Measuring uncertainty for a level of confidence of 95% $U=2Ue(y)$	Normal (k=2)	± 4.2 dB



Global Certification Corp.

Appendix 1

PHOTOS OF TEST CONFIGURATION

01 CE Front View



02 CE Rear View



03 RE Front View

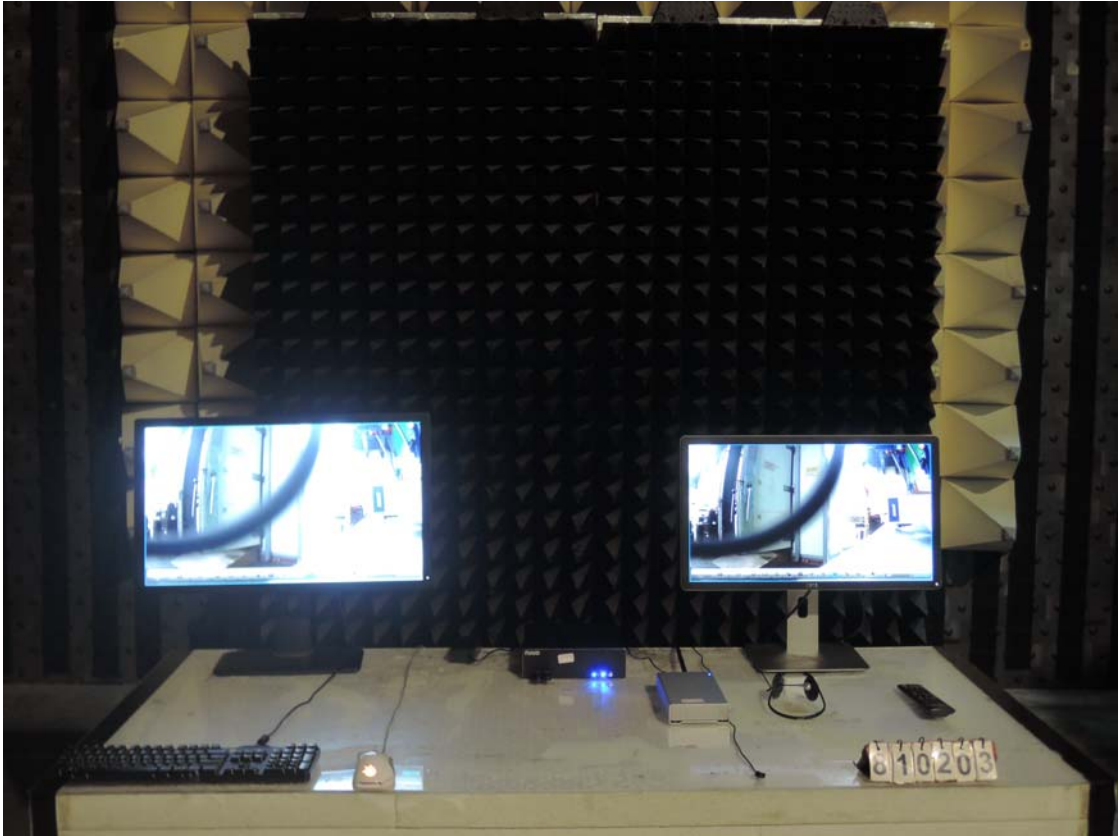

04 RE Rear View



05 Harmonics & Flicker & Surge & DIPS



06 ESD



07 RS

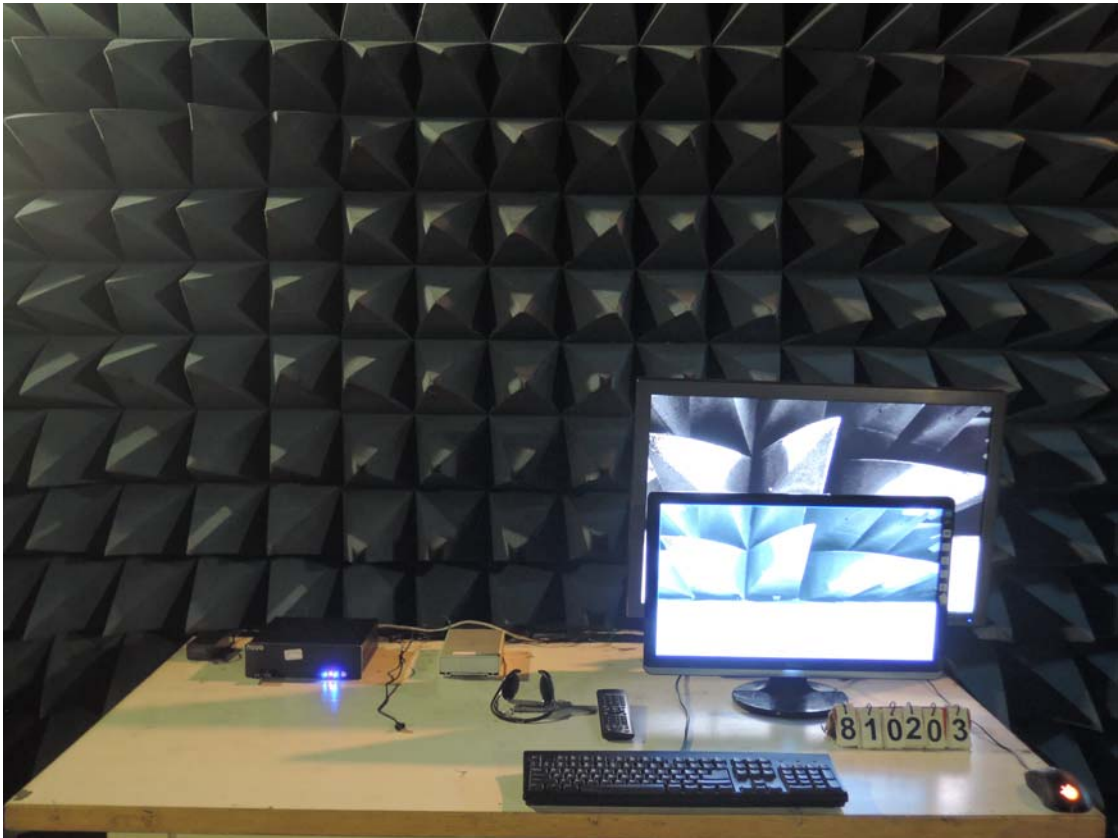

08 EFT





10 PFMF





Global Certification Corp.

Appendix 2

TEST DATA



Date:2018-1-19

Site : GCC_CE_01
RBW : 9 KHz VBW : 300 KHz SWT : Auto
EUT : Network Video Recorder
Mode : Recording 1920*1080
Voltage : 230Vac 50Hz

Regulations : CISPR32 B QP
Phase : LINE
Model : NP2160
Temp/Humidity : 20°C / 70%
Memo :

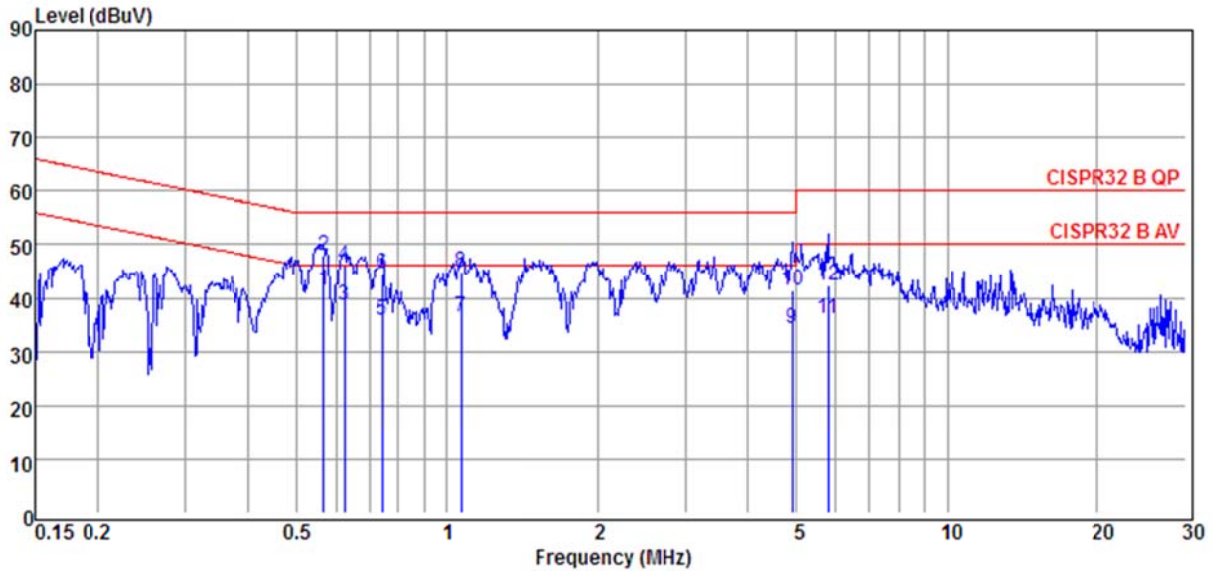

	Freq MHz	Meter Level dBuV	System Factor dB	Cable Loss dB	LISN Factor dB	Real Level dBuV	Limit Line dBuV	Margin dB	Remark
1	0.57	21.20	20.18	20.16	0.02	41.38	46.00	-4.62	Average
2	0.57	27.77	20.18	20.16	0.02	47.95	56.00	-8.05	QP
3	0.62	18.50	20.19	20.17	0.02	38.69	46.00	-7.31	Average
4	0.62	25.75	20.19	20.17	0.02	45.94	56.00	-10.06	QP
5	0.74	15.72	20.21	20.18	0.03	35.93	46.00	-10.07	Average
6	0.74	24.36	20.21	20.18	0.03	44.57	56.00	-11.43	QP
7	1.07	16.09	20.22	20.19	0.03	36.31	46.00	-9.69	Average
8	1.07	24.53	20.22	20.19	0.03	44.75	56.00	-11.25	QP
9	4.90	13.74	20.43	20.34	0.09	34.17	46.00	-11.83	Average
10	4.90	20.90	20.43	20.34	0.09	41.33	56.00	-14.67	QP
11	5.81	15.61	20.47	20.36	0.11	36.08	50.00	-13.92	Average
12	5.81	21.74	20.47	20.36	0.11	42.21	60.00	-17.79	QP

System Factor = Cable Loss + LISN Factor

Cable Loss = Pulse limiter + Cable Insertion Loss

Real Level = Meter Level + System Factor

Margin = Real Level - Limit Line



Date:2018-1-19

Site : GCC_CE_01
RBW : 9 KHz VBW : 300 KHz SWT : Auto
EUT : Network Video Recorder
Mode : Recording 1920*1080
Voltage : 230Vac 50Hz

Regulations : CISPR32 B QP
Phase : NEUTRAL
Model : NP2160
Temp/Humidity : 20°C / 70%
Memo :

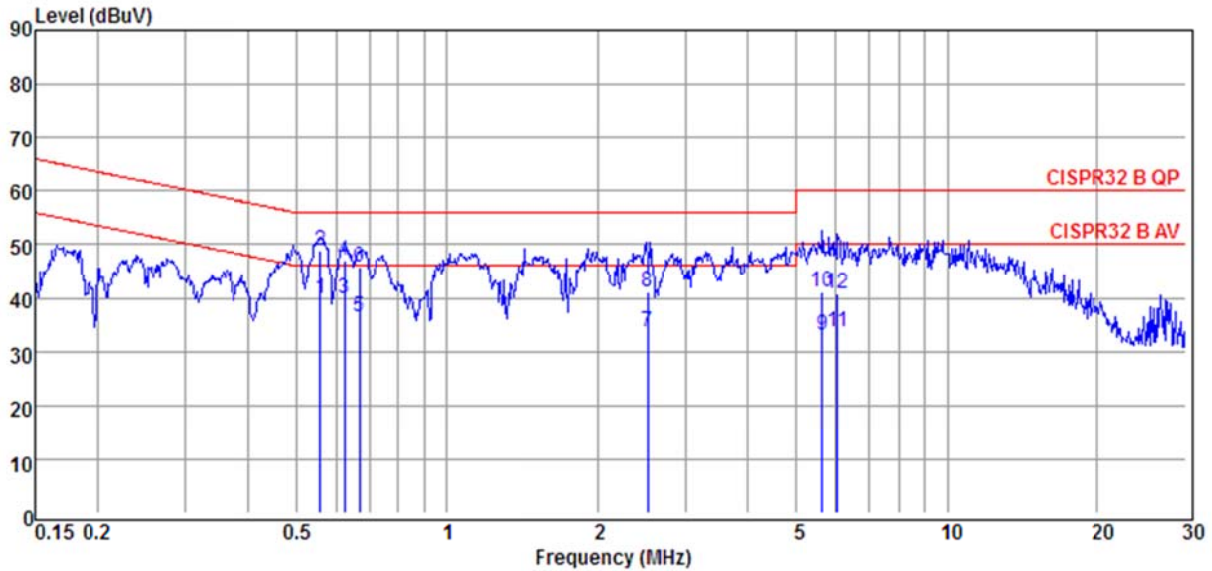

	Freq MHz	Meter Level dBuV	System Factor dB	Cable Loss dB	LISN Factor dB	Real Level dBuV	Limit Line dBuV	Margin dB	Remark
1	0.56	19.63	20.19	20.16	0.03	39.82	46.00	-6.18	Average
2	0.56	28.71	20.19	20.16	0.03	48.90	56.00	-7.10	QP
3	0.62	19.71	20.20	20.17	0.03	39.91	46.00	-6.09	Average
4	0.62	26.76	20.20	20.17	0.03	46.96	56.00	-9.04	QP
5	0.67	16.22	20.21	20.17	0.04	36.43	46.00	-9.57	Average
6	0.67	25.54	20.21	20.17	0.04	45.75	56.00	-10.25	QP
7	2.52	13.26	20.32	20.25	0.07	33.58	46.00	-12.42	Average
8	2.52	20.64	20.32	20.25	0.07	40.96	56.00	-15.04	QP
9	5.65	12.55	20.48	20.36	0.12	33.03	50.00	-16.97	Average
10	5.65	20.63	20.48	20.36	0.12	41.11	60.00	-18.89	QP
11	6.06	13.12	20.50	20.37	0.13	33.62	50.00	-16.38	Average
12	6.06	20.32	20.50	20.37	0.13	40.82	60.00	-19.18	QP

System Factor = Cable Loss + LISN Factor

Cable Loss = Pulse limiter + Cable Insertion Loss

Real Level = Meter Level + System Factor

Margin = Real Level - Limit Line



Date:2018-1-19

Site : GCC_CE_01
RBW : 9 KHz VBW : 300 KHz SWT : Auto
EUT : Network Video Recorder
Mode : LAN1 Link 100M
Voltage : 230Vac 50Hz

Regulations : ISN CISPR32 B QP
Model : NP-2160
Temp/Humidity : 20°C / 70%
Memo :

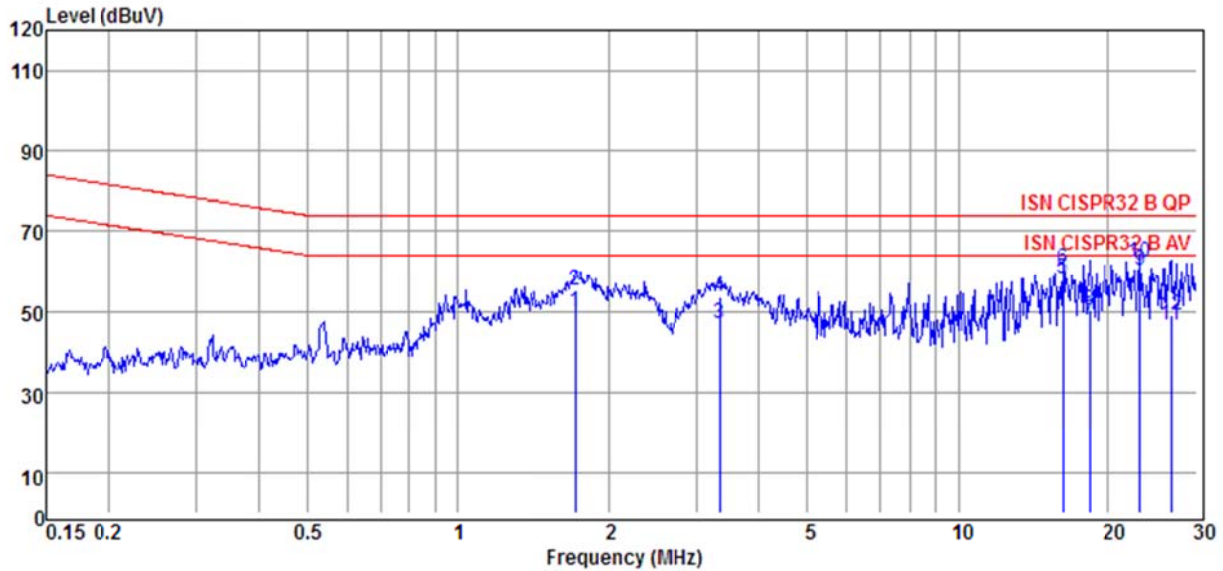

	Freq MHz	Meter Level dBuV	System Factor dB	Cable Loss dB	ISN Factor dB	Real Level dBuV	Limit Line dBuV	Margin dB	Remark
1	1.72	20.13	29.79	20.06	9.73	49.92	64.00	-14.08	Average
2	1.72	25.38	29.79	20.06	9.73	55.17	74.00	-18.83	QP
3	3.35	17.22	29.77	20.08	9.69	46.99	64.00	-17.01	Average
4	3.35	23.67	29.77	20.08	9.69	53.44	74.00	-20.56	QP
5	16.23	27.99	30.04	20.16	9.88	58.03	64.00	-5.97	Average
6	16.23	30.46	30.04	20.16	9.88	60.50	74.00	-13.50	QP
7	18.31	17.42	30.13	20.17	9.96	47.55	64.00	-16.45	Average
8	18.31	20.00	30.13	20.17	9.96	50.13	74.00	-23.87	QP
9	23.13	30.05	30.35	20.19	10.16	60.40	64.00	-3.60	Average
10	23.13	32.06	30.35	20.19	10.16	62.41	74.00	-11.59	QP
11	26.70	16.05	30.52	20.20	10.32	46.57	64.00	-17.43	Average
12	26.70	18.32	30.52	20.20	10.32	48.84	74.00	-25.16	QP

System Factor = Cable Loss + ISN Factor
Cable Loss = Pulse limiter + Cable Insertion Loss
Real Level = Meter Level + System Factor
Margin = Real Level - Limit Line



Date:2018-1-19

Site : GCC_CE_01
RBW : 9 KHz VBW : 300 KHz SWT : Auto
EUT : Network Video Recorder
Mode : LAN2 Link 100M
Voltage : 230Vac 50Hz

Regulations : ISN CISPR32 B QP
Model : NP-2160
Temp/Humidity : 20°C / 70%
Memo :

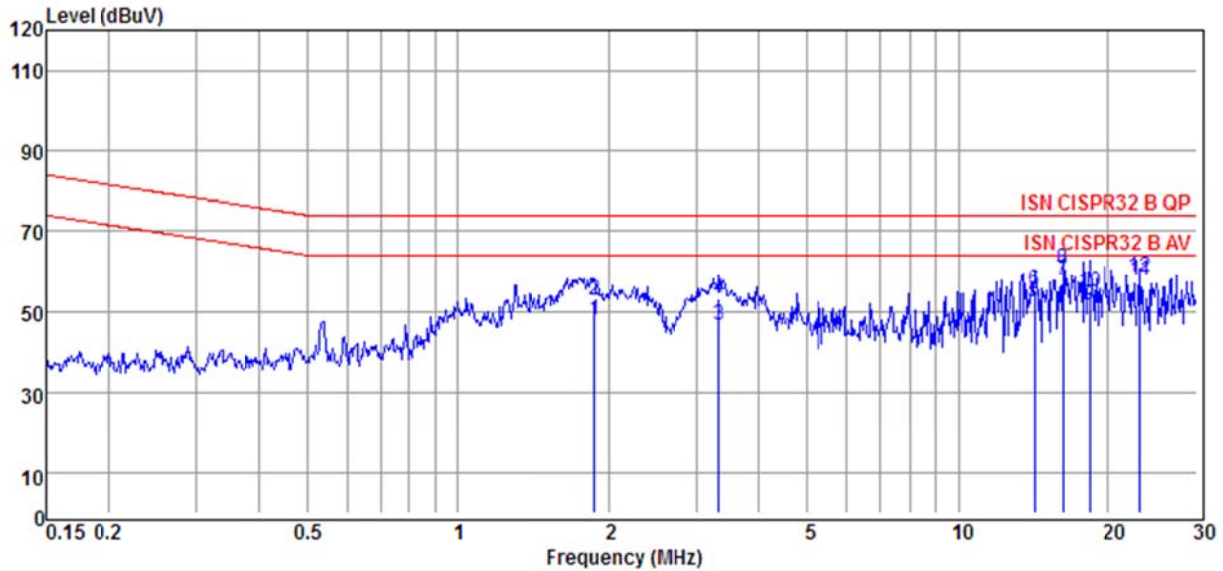

	Freq MHz	Meter Level dBuV	System Factor dB	Cable Loss dB	ISN Factor dB	Real Level dBuV	Limit Line dBuV	Margin dB	Remark
1	1.87	17.89	29.78	20.06	9.72	47.67	64.00	-16.33	Average
2	1.87	22.86	29.78	20.06	9.72	52.64	74.00	-21.36	QP
3	3.33	16.72	29.77	20.08	9.69	46.49	64.00	-17.51	Average
4	3.33	23.26	29.77	20.08	9.69	53.03	74.00	-20.97	QP
5	14.21	22.25	29.97	20.15	9.82	52.22	64.00	-11.78	Average
6	14.21	25.29	29.97	20.15	9.82	55.26	74.00	-18.74	QP
7	16.23	27.56	30.04	20.16	9.88	57.60	64.00	-6.40	Average
8	16.23	30.56	30.04	20.16	9.88	60.60	74.00	-13.40	QP
9	18.30	21.43	30.13	20.17	9.96	51.56	64.00	-12.44	Average
10	18.30	24.52	30.13	20.17	9.96	54.65	74.00	-19.35	QP
11	23.13	27.56	30.35	20.19	10.16	57.91	64.00	-6.09	Average
12	23.13	28.26	30.35	20.19	10.16	58.61	74.00	-15.39	QP

System Factor = Cable Loss + ISN Factor
Cable Loss = Pulse limiter + Cable Insertion Loss
Real Level = Meter Level + System Factor
Margin = Real Level - Limit Line



Date:2018-1-22

Site : GCC_RE
RBW : 120 KHz VBW : 300 KHz SWT :
Auto
EUT : Network Video Recorder
Mode : Recording 1920*1080
Voltage : 230Vac 50Hz

Regulations : CISPR32 B QP (3M)
Polarity : HORIZONTAL
Model : NP-2160
Temp/Humidity : 23°C / 55%
Memo :

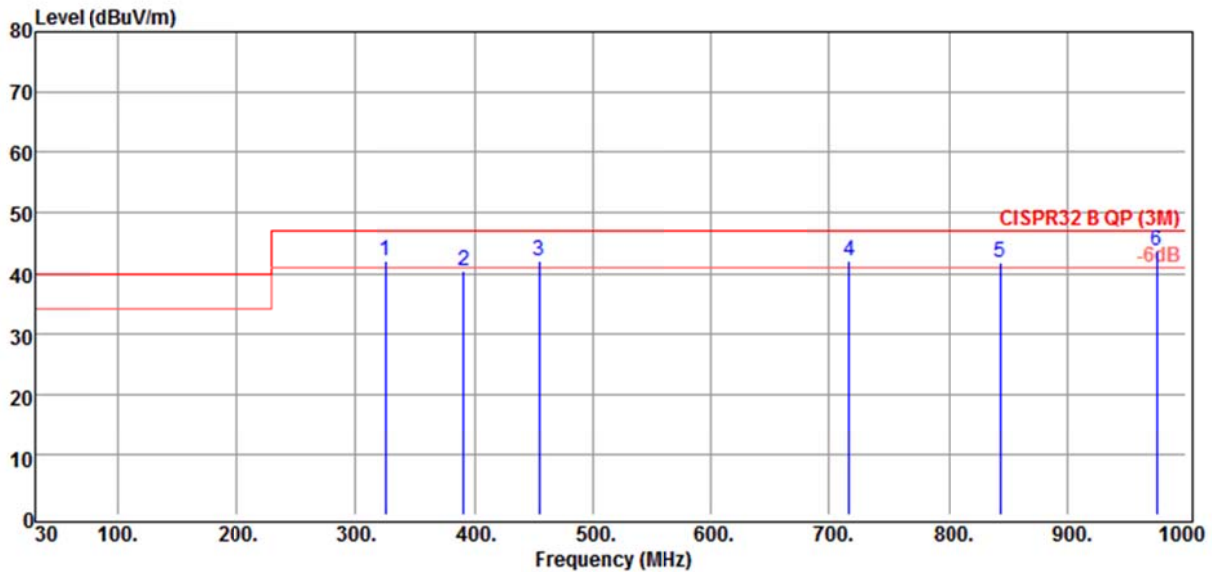

Freq MHz	Meter Level dBuV	System Factor dB/m	Cable Loss dB	Antenna Factor dB/m	Preamp Gain dB	Real Level dBuV/ m	Limit Line dBuV/ m	Margin dB	Remark	
1	325.85	48.43	-6.30	1.90	20.62	28.82	42.13	47.00	-4.87	QP
2	390.84	44.97	-4.47	2.12	22.08	28.67	40.50	47.00	-6.50	QP
3	454.86	44.81	-2.74	2.30	23.39	28.43	42.07	47.00	-4.93	QP
4	716.76	38.96	3.07	2.98	26.93	26.84	42.03	47.00	-4.97	QP
5	843.83	36.19	5.56	3.30	28.35	26.09	41.75	47.00	-5.25	QP
6	975.75	35.58	8.14	3.61	29.81	25.28	43.72	47.00	-3.28	QP

System Factor = Cable Loss + Antenna Factor - Preamp Gain

Real Level = Meter Level + System Factor

Margin = Real Level - Limit Line



Date:2018-1-22

Site : GCC_RE
RBW : 120 KHz VBW : 300 KHz SWT :
Auto
EUT : Network Video Recorder
Mode : Recording 1920*1080
Voltage : 120Vac 60Hz

Regulations : CISPR B QP (3M)
Polarity : HORIZONTAL

Model : NP-2160
Temp/Humidity : 23°C / 55%
Memo :

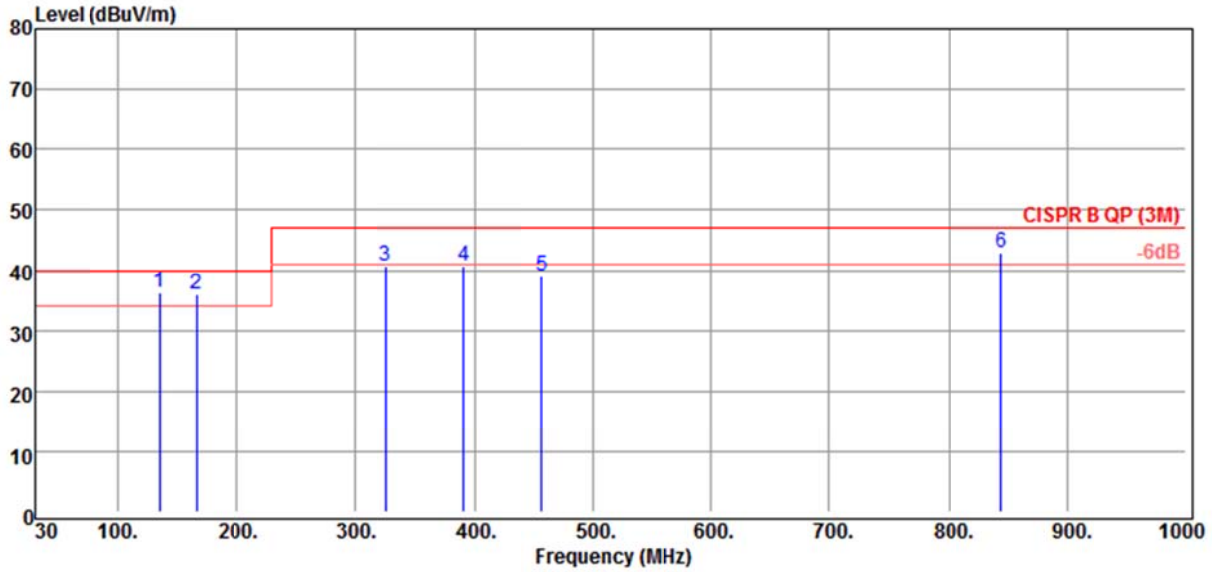

Freq	Meter	Syste	Cable	Antenna	Preamp	Real	Limit	Margin	Remark	
MHz	Level	m	Loss	Factor	Gain	Level	Line	dB		
	dBuV	Factor	dB	dB/m	dB	dBuV/ m	dBuV/ m			
1	134.76	43.86	-7.70	1.09	20.21	29.00	36.16	40.00	-3.84	QP
2	165.80	45.00	-9.11	1.24	18.69	29.04	35.89	40.00	-4.11	QP
3	325.85	46.93	-6.30	1.90	20.62	28.82	40.63	47.00	-6.37	QP
4	390.84	45.29	-4.47	2.12	22.08	28.67	40.82	47.00	-6.18	QP
5	456.80	41.63	-2.69	2.31	23.42	28.42	38.94	47.00	-8.06	QP
6	844.80	37.19	5.59	3.31	28.36	26.08	42.78	47.00	-4.22	QP

System Factor = Cable Loss + Antenna Factor - Preamp Gain

Real Level = Meter Level + System Factor

Margin = Real Level - Limit Line



Date:2018-1-19

Site : GCC_RE_01
RBW : 1000 KHz VBW : 1000 KHz SWT :
Auto
EUT : Network Video Recorder
Mode : Recording 1920*1080
Voltage : 230Vac 50Hz

Regulations : CISPR32 B 1G-6G PK
Polarity : HORIZONTAL
Model : NP-2160
Temp/Humidity : 23°C / 55%
Memo :

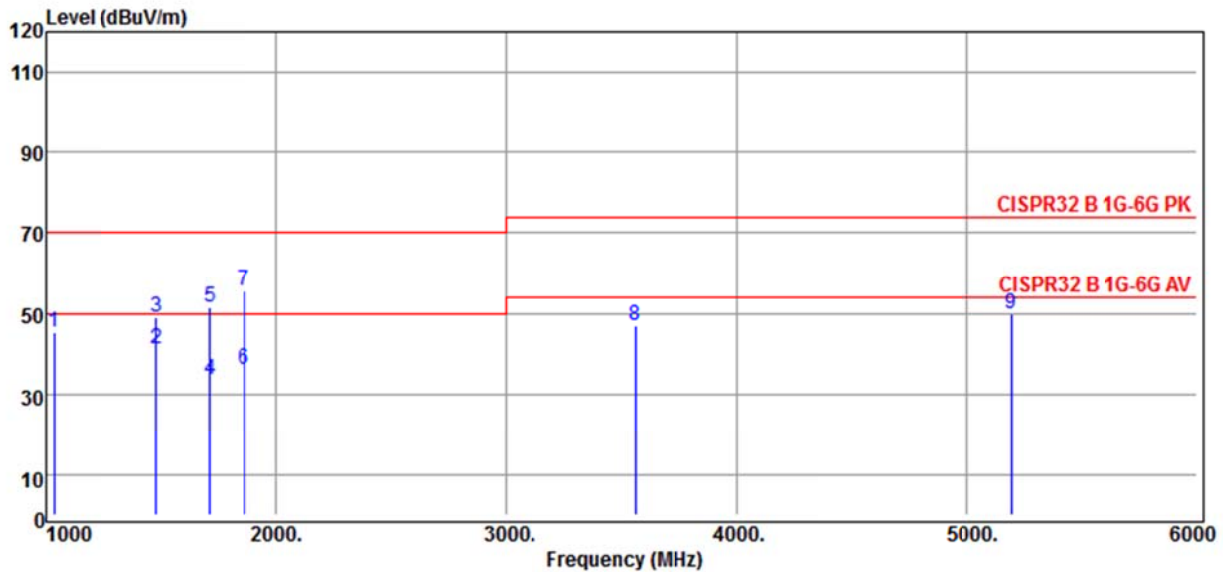

Freq	Meter	System	Cable	Antenna	Preamp	Real	Limit	Margin	Remark
MHz	Level	Factor	Loss	Factor	Gain	Level	Line	dB	
	dBuV	dB/m	dB	dB/m	dB	dBuV/ m	dBuV/ m		

1	1035.00	61.30	-16.04	2.86	28.11	47.01	45.26	70.00	-24.74	Peak
2	1480.00	56.54	-15.43	3.38	28.29	47.10	41.11	50.00	-8.89	Average
3	1480.00	64.24	-15.43	3.38	28.29	47.10	48.81	70.00	-21.19	Peak
4	1710.00	47.21	-13.55	3.65	29.77	46.97	33.66	50.00	-16.34	Average
5	1710.00	65.10	-13.55	3.65	29.77	46.97	51.55	70.00	-18.45	Peak
6	1860.00	48.41	-12.23	3.83	30.82	46.88	36.18	50.00	-13.82	Average
7	1860.00	67.94	-12.23	3.83	30.82	46.88	55.71	70.00	-14.29	Peak
8	3560.00	55.96	-9.13	4.75	32.92	46.80	46.83	74.00	-27.17	Peak
9	5195.00	55.23	-5.54	6.56	34.66	46.76	49.69	74.00	-24.31	Peak

System Factor = Cable Loss + Antenna Factor - Preamp Gain

Real Level = Meter Level + System Factor

Margin = Real Level - Limit Line



Date:2018-1-19

Site : GCC_RE_01
RBW : 1000 KHz VBW : 1000 KHz SWT :
Auto
EUT : Network Video Recorder
Mode : Recording 1920*1080
Voltage : 230Vac 50Hz

Regulations : CISPR32 B 1G-6G PK
Polarity : VERTICAL
Model : NP-2160
Temp/Humidity : 23°C / 55%
Memo :

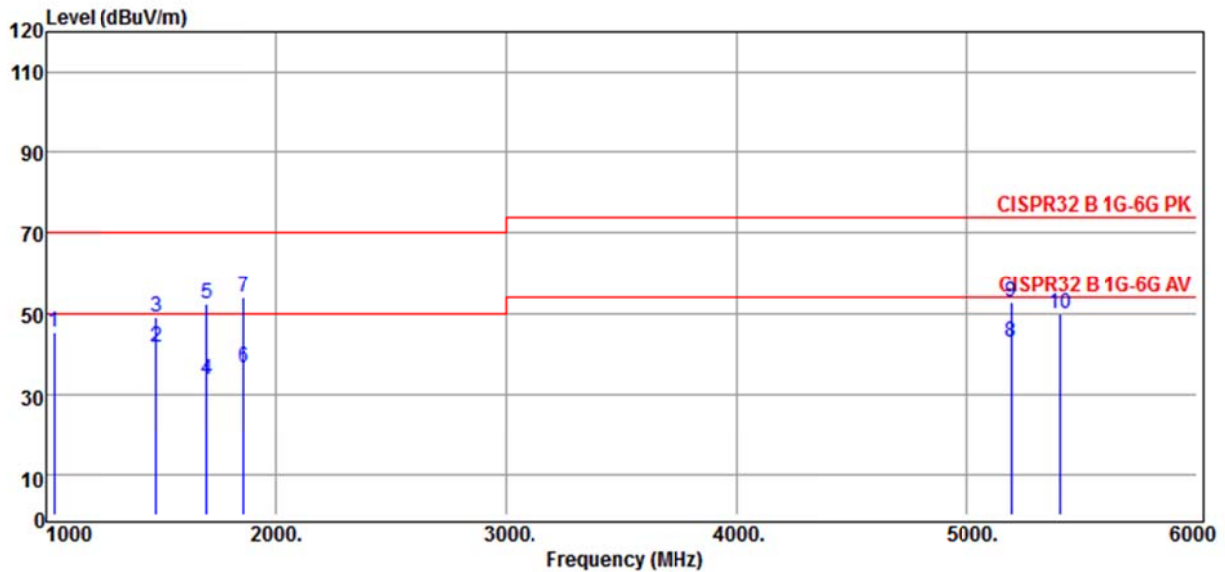

Freq MHz	Meter Level dBuV	System Factor dB/m	Cable Loss dB	Antenna Factor dB/m	Preamp Gain dB	Real Level dBuV/ m	Limit Line dBuV/ m	Margin dB	Remark
-------------	------------------------	--------------------------	---------------------	---------------------------	----------------------	-----------------------------	-----------------------------	--------------	--------

1	1035.00	61.45	-16.04	2.86	28.11	47.01	45.41	70.00	-24.59	Peak
2	1480.00	56.89	-15.43	3.38	28.29	47.10	41.46	50.00	-8.54	Average
3	1480.00	64.23	-15.43	3.38	28.29	47.10	48.80	70.00	-21.20	Peak
4	1695.00	47.21	-13.69	3.63	29.66	46.98	33.52	50.00	-16.48	Average
5	1695.00	65.86	-13.69	3.63	29.66	46.98	52.17	70.00	-17.83	Peak
6	1855.00	48.65	-12.29	3.82	30.78	46.89	36.36	50.00	-13.64	Average
7	1855.00	66.23	-12.29	3.82	30.78	46.89	53.94	70.00	-16.06	Peak
8	5195.00	48.11	-5.54	6.56	34.66	46.76	42.57	54.00	-11.43	Average
9	5195.00	58.47	-5.54	6.56	34.66	46.76	52.93	74.00	-21.07	Peak
10	5405.00	55.22	-5.38	6.72	34.62	46.72	49.84	74.00	-24.16	Peak

System Factor = Cable Loss + Antenna Factor - Preamp Gain

Real Level = Meter Level + System Factor

Margin = Real Level - Limit Line

Harmonics – Class-A per Ed. 4.0 (2014)(Run time)

EUT: Network Video Recorder

Test category: Class-A per Ed. 4.0 (2014) (European limits)

Test date: 2018-01-22

Start time: 1:59:47 PM

Tested by: Ken

Test Margin: 100

End time: 2:05:08 PM

Comment: NP-2160

Customer: NUUO INC.

Test Result: Pass

Source qualification: Normal

Current & voltage waveforms

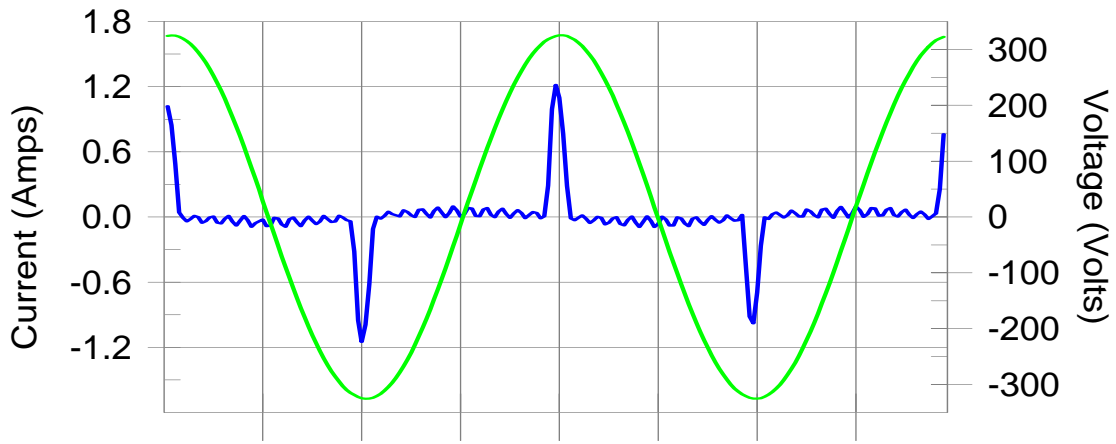

Harmonics and Class A limit line

European Limits

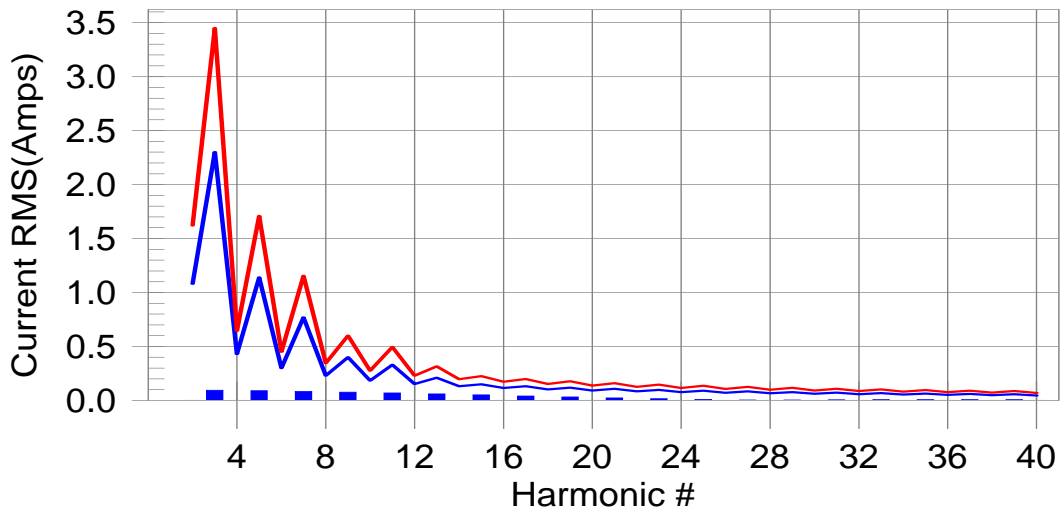

Test result: Pass Worst harmonic was #15 with 22.8% of the limit.

Current Test Result Summary (Run time)

EUT: Network Video Recorder Tested by: Ken
 Test category: Class-A per Ed. 4.0 (2014) (European limits) Test Margin: 100
 Test date: 2018-01-22 Start time: 1:59:47 PM End time: 2:05:08 PM

Comment: NP-2160
 Customer: NUUO INC.

Test Result: Pass Source qualification: Normal
 THC(A): 0.213 I-THD(%): 206.5 POHC(A): 0.034 POHC Limit(A): 0.251

Highest parameter values during test:

V_RMS (Volts): 230.03	Frequency(Hz): 50.00
I_Peak (Amps): 1.243	I_RMS (Amps): 0.248
I_Fund (Amps): 0.105	Crest Factor: 5.142
Power (Watts): 22.7	Power Factor: 0.409

Harm#	Harms(avg)	100%Limit	%of Limit	Harms(max)	150%Limit	%of Limit	Status
2	0.002	1.080	N/A	0.002	1.620	N/A	Pass
3	0.095	2.300	4.1	0.097	3.450	2.8	Pass
4	0.002	0.430	N/A	0.002	0.645	N/A	Pass
5	0.091	1.140	7.9	0.092	1.710	5.4	Pass
6	0.002	0.300	N/A	0.002	0.450	N/A	Pass
7	0.085	0.770	11.0	0.087	1.155	7.5	Pass
8	0.002	0.230	N/A	0.002	0.345	N/A	Pass
9	0.078	0.400	19.5	0.079	0.600	13.2	Pass
10	0.001	0.184	N/A	0.002	0.276	N/A	Pass
11	0.070	0.330	21.1	0.070	0.495	14.2	Pass
12	0.001	0.153	N/A	0.002	0.230	N/A	Pass
13	0.060	0.210	28.8	0.061	0.315	19.4	Pass
14	0.001	0.131	N/A	0.002	0.197	N/A	Pass
15	0.051	0.150	34.0	0.051	0.225	22.8	Pass
16	0.001	0.115	N/A	0.001	0.173	N/A	Pass
17	0.041	0.132	31.4	0.042	0.198	21.1	Pass
18	0.001	0.102	N/A	0.001	0.153	N/A	Pass
19	0.032	0.118	27.2	0.032	0.178	18.3	Pass
20	0.001	0.092	N/A	0.001	0.138	N/A	Pass
21	0.024	0.107	22.1	0.024	0.161	14.9	Pass
22	0.001	0.084	N/A	0.001	0.125	N/A	Pass
23	0.016	0.098	16.4	0.016	0.147	11.1	Pass
24	0.001	0.077	N/A	0.001	0.115	N/A	Pass
25	0.010	0.090	10.7	0.010	0.135	7.4	Pass
26	0.000	0.071	N/A	0.001	0.107	N/A	Pass
27	0.005	0.083	6.1	0.005	0.125	4.2	Pass
28	0.000	0.066	N/A	0.001	0.099	N/A	Pass
29	0.004	0.078	N/A	0.004	0.116	N/A	Pass
30	0.000	0.061	N/A	0.001	0.092	N/A	Pass
31	0.005	0.073	7.3	0.006	0.109	5.3	Pass
32	0.001	0.058	N/A	0.001	0.086	N/A	Pass
33	0.007	0.068	9.9	0.007	0.102	6.9	Pass
34	0.000	0.054	N/A	0.001	0.081	N/A	Pass
35	0.007	0.064	11.4	0.008	0.096	7.9	Pass
36	0.000	0.051	N/A	0.001	0.077	N/A	Pass
37	0.007	0.061	11.9	0.007	0.091	8.1	Pass
38	0.000	0.048	N/A	0.001	0.073	N/A	Pass
39	0.006	0.058	11.1	0.007	0.087	7.5	Pass
40	0.000	0.046	N/A	0.000	0.069	N/A	Pass

Voltage Source Verification Data (Run time)

EUT: Network Video Recorder Tested by: Ken
Test category: Class-A per Ed. 4.0 (2014) (European limits) Test Margin: 100
Test date: 2018-01-22 Start time: 1:59:47 PM End time: 2:05:08 PM

Comment: NP-2160
Customer: NUUO INC.

Test Result: Pass Source qualification: Normal

Highest parameter values during test:

Voltage (Vrms): 230.03 Frequency(Hz): 50.00
I_Peak (Amps): 1.243 I_RMS (Amps): 0.248
I_Fund (Amps): 0.105 Crest Factor: 5.142
Power (Watts): 22.7 Power Factor: 0.409

Harm#	Harmonics V-rms	Limit V-rms	% of Limit	Status
2	0.104	0.460	22.54	OK
3	0.449	2.070	21.67	OK
4	0.022	0.460	4.75	OK
5	0.020	0.920	2.22	OK
6	0.014	0.460	3.14	OK
7	0.040	0.690	5.86	OK
8	0.020	0.460	4.32	OK
9	0.025	0.460	5.39	OK
10	0.013	0.460	2.87	OK
11	0.038	0.230	16.46	OK
12	0.017	0.230	7.37	OK
13	0.036	0.230	15.79	OK
14	0.011	0.230	4.92	OK
15	0.035	0.230	15.28	OK
16	0.017	0.230	7.56	OK
17	0.029	0.230	12.77	OK
18	0.020	0.230	8.91	OK
19	0.029	0.230	12.67	OK
20	0.010	0.230	4.35	OK
21	0.019	0.230	8.39	OK
22	0.008	0.230	3.43	OK
23	0.022	0.230	9.54	OK
24	0.006	0.230	2.64	OK
25	0.011	0.230	4.61	OK
26	0.008	0.230	3.48	OK
27	0.010	0.230	4.32	OK
28	0.006	0.230	2.73	OK
29	0.006	0.230	2.64	OK
30	0.007	0.230	3.10	OK
31	0.007	0.230	3.08	OK
32	0.006	0.230	2.69	OK
33	0.011	0.230	4.65	OK
34	0.003	0.230	1.37	OK
35	0.011	0.230	4.68	OK
36	0.005	0.230	2.09	OK
37	0.016	0.230	7.16	OK
38	0.003	0.230	1.27	OK
39	0.011	0.230	4.68	OK
40	0.007	0.230	3.20	OK

Flicker Test Summary per EN/IEC61000-3-3 Ed. 3.0 (2013) (Run time)

EUT: Network Video Recorder
 Test category: All parameters (European limits)
 Test date: 2018-01-22 Start time: 2:12:46 PM

Tested by: Ken
 Test Margin: 100
 End time: 2:23:17 PM

Comment: NP-2160
 Customer: NUUO INC.

Test Result: Pass

Status: Test Completed

P_{st} and limit line

European Limits

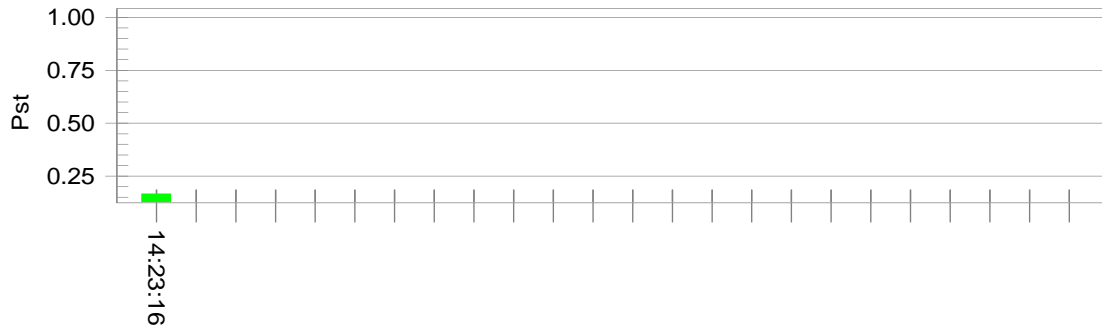

Plt and limit line

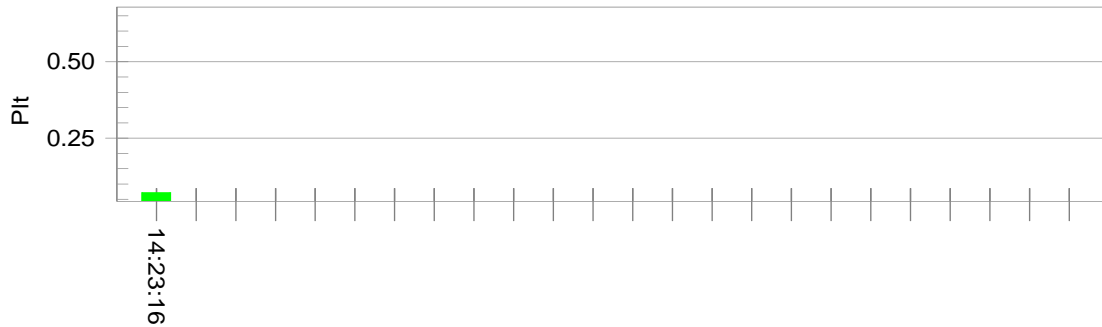

Parameter values recorded during the test:

Vrms at the end of test (Volt):	230.00		
Highest dt (%):	0.00	Test limit (%):	N/A N/A
T-max (mS):	0	Test limit (mS):	500.0 Pass
Highest dc (%):	0.00	Test limit (%):	3.30 Pass
Highest dmax (%):	0.02	Test limit (%):	4.00 Pass
Highest Pst (10 min. period):	0.166	Test limit:	1.000 Pass
Highest Plt (2 hr. period):	0.072	Test limit:	0.650 Pass