



FCC 47 CFR PART 15 SUBPART B

TEST REPORT

FOR

Network Video Recorder

Model : NP-8320,NP-8Bay,NP-8XXX(XXX=160,200
,220,240,320,360,400,420,460,480,600,640)
Trade Name: NUUO

Issued to

NUUO Inc.
10F., No.285, Sec. 2, Wenhua Rd. Banqiao Dist., New Taipei City 220, TAIWAN
(R.O.C.)

Issued by

Global Certification Corp.
No.146, Sec. 2, Xiangzhang Rd., Xizhi Dist., New Taipei City 221,
Taiwan (R.O.C.)



Note: This test refers exclusively to the test presented test model and sample. This report shall not be reproduced except in full, without the written approval of Global Certification Corporation. This document may be altered or revised by Global Certification Corporation. Personnel only, and shall be noted in the revision section of the document.



Revision History

Revision	No.	Report Number	Issue Date	Description	Author/ Revised by
1.	670103	670103	Aug. 05, 2016	Original Report	Judy
2.	690601	670103-01	Sep. 07, 2017	Copy Report	Judy
3.	7N0302	670103-02	Nov. 15, 2017	Update Standard to ANSI C63.4:2014	Judy



TABLE OF CONTENTS -----	3
1. GENERAL INFORMATION -----	4
1.1 DESCRIPTION OF THE TESTED SAMPLES -----	5
1.2 I/O PORT OF THE EUT-----	5
1.3 TEST METHODOLOGY -----	6
1.4 DESCRIPTION OF THE SUPPORT EQUIPMENTS-----	7
1.5 FEATURES OF EUT -----	8
2. INSTRUMENT AND CALIBRATION -----	9
2.1 MEASURING INSTRUMENT CALIBRATION-----	9
2.2 TEST AND MEASUREMENT EQUIPMENT-----	9
2.3 TEST PERFORMED-----	10
2.4 APPENDIX -----	10
3. CONDUCTED EMISSION MEASUREMENT -----	13
3.1 TEST SET-UP -----	13
3.2 LIMIT-----	13
3.3 TEST PROCEDURE-----	13
3.4 TEST SPECIFICATION -----	14
3.5 TEST DATA -----	14
3.6 RESULT-----	14
4. RADIATED EMISSION MEASUREMENT -----	15
4.1 TEST SETUP -----	15
4.2 LIMIT-----	16
4.3 TEST PROCEDURE-----	16
4.4 TEST SPECIFICATION -----	17
4.5 TEST DATA -----	17
4.6 RESULT-----	17
5. EMC MODIFICATION & ESTIMATED MEASUREMENT UNCERTAINTY -----	18
5.1 EMC MODIFICATION -----	18
5.2 ESTIMATED MEASUREMENT UNCERTAINTY -----	18
SAMPLE OF FCC DOC LABEL 2 -----	19

APPENDIX 1

PHOTOS OF TEST CONFIGURATION

APPENDIX 2

TEST DATA

APPENDIX 3

PHOTOS OF EUT



1. GENERAL INFORMATION

Applicant : NUUO Inc.
Address : 10F., No.285, Sec. 2, Wenhua Rd. Banqiao Dist., New Taipei City 220, TAIWAN (R.O.C.)
Manufacturer : NUUO Inc.
Address : 10F., No.285, Sec. 2, Wenhua Rd. Banqiao Dist., New Taipei City 220, TAIWAN (R.O.C.)
EUT : Network Video Recorder
Model No. : NP-8320,NP-8Bay,NP-8XXX(XXX=160,200,220,240,320,360,400,420,460,480,600,640
Trade Name : NUUO
Model Differences : The major electrical and mechanical constructions of series models are identical to the basic model, except different Software. The model, NP-8320 is the testing sample, and the final test data are shown on this test report.

Is herewith confirmed to comply with the requirements set out in the FCC Rules and Regulations Part 15 Subpart B and CISPR 22 and the measurement procedures were according to ANSI C63.4:2014. The said equipment in the configuration described in this report shows the maximum emission levels emanating from equipment are within the compliance requirements.

FCC part 15 subpart B

Class A

Tested By:

Approved by:

Aug. 05, 2016
Date



Bob Yao, Engineer

Nov. 15, 2017
Re-issued Date



Adam Chou, Manager
Designation Number: TW1089



1.1 DESCRIPTION OF THE TESTED SAMPLES

EUT

EUT Type : Normal Type Engineering Type

EUT Name : Network Video Recorder

Model No. : NP-8320

EUT Power Type : AC Power

DC Power

DCV from PC

DCV from Adaptor

Power Rating : I/P: 100-240Vac, 50-60Hz, 3.5-2A

The frequency of the EUT

Highest Operating Frequency : 1.6GHz

EUT Received Date : Jul. 01, 2016

EMC Test Completed Date : Jul. 29, 2016

1.2 I/O PORT OF THE EUT

I/O port type	Q'ty	Tested with
HDMI Port	1	1
VGA Port	1	1
USB3.0 Port	1	1
USB2.0 Port	3	3
e-SATA Port	1	1
LAN Port	2	2
Audio IN Port	1	1
Audio OUT Port	1	1
Alarm Port	2	2



1.3 TEST METHODOLOGY

EUT SYSTEM OPERATION

- 1.The EUT was configured according to ANSI C63.4:2014 & CISPR 22 Class A.
- 2.All I/O ports are connected to the appropriate peripherals.
- 3.Photos of test configuration please refer to appendix 1.
- 4.Perform the EMC testing procedures, and measure the maximum emission noise.

DECISION OF FINAL TEST MODE

Mode : Recorder ; LAN 100M



1.4 DESCRIPTION OF THE SUPPORT EQUIPMENTS

Setup Diagram

See test photographs attached in appendix I for the actual connections between EUT and support equipment.

Support Equipment

Peripherals Devices:

OUTSIDE SUPPORT EQUIPMENT							
No.	Equipment	Model	Serial No.	FCC ID/ BSMI ID	Trade name	Data Cable	Power Cord
1.	POE Hub	POI-3004	14033100035	N/A	Gigabit	N/A	1.8m
2.	POE Hub	POE-151	AF001023005 14(000)	N/A	PLANT	N/A	0.7m
3	LAN Hub	DI-604	DYIU281002 248	N/A	D-Link	N/A	1.5m
4	3.5"HDD1	OF 12115 MNR5C00C18	F328X8ND	N/A	HITACHI	N/A	N/A
5	3.5"HDD2	OF 12115 MNR5C00C188	F328GLUD	N/A	HITACHI	N/A	N/A
6	3.5"HDD3	OF 12115 MNR5C00C18	F328T4ZD	N/A	HITACHI	N/A	N/A
7	3.5"HDD4	OF 12115 MNR5C00C18	F328J32D	N/A	HITACHI	N/A	N/A
8	3.5"HDD5	OF 12115 MNR5C00C18	F328L6XD	N/A	HITACHI	N/A	N/A
9	3.5"HDD6	OF 12115 MNR5C00C18	F328SGZD	N/A	HITACHI	N/A	N/A
10	3.5"HDD7	OF 12115 MNR5C00C18	F328LPAD	N/A	HITACHI	N/A	N/A
11	3.5"HDD8	OF 12115 MNR5C00C18	F328L7JD	N/A	HITACHI	N/A	N/A
12	IP Camera	E23	N/A	N/A	ACTi	N/A	N/A
13	IP Camera	E210	N/A	N/A	ACTi	N/A	N/A
14	NB	Compaq Presario V3000	2CE7202SLC	R33001	HP	Unshielded 15m	Unshielded 1.8m
15	MONITOR (HDMI)	EM-24VT08D	366603009	R41A01	SAMPO	Shielded 1.6m	UnShielded 1.8m
16	MONITOR (VGA)	ST2220Lb	CN-OHXG8 5-74261-223 -043L	R43002	DELL	Shielded 1.8m	UnShielded 1.8m
17	USB3.0 Flash	N/A	N/A	D33193	TRANSC END	N/A	N/A
18	USB Flash	D33193 N14939	701178 2482	D33193	TRANSC END	N/A	N/A
19	KEY BOARD	1576	0066904835 022	R31264	Microsoft	Unshielded 1.2m / USB	N/A



20	EAR PHONE	E220	N/A	N/A	DeeJay	Unshielded 2m	N/A
21	Mouse	N/A	N/A	N/A	NUUO	1.1m	N/A
22	e-SATA 3.5” HDD	N/A	N/A	N/A	N/A	1.8m	N/A
EUT ACCESSORIES/COMPONENTS							
No.	Equipment	Model	Serial No.	FCC ID/ BSMI ID	Trade name	Data Cable	Power Cord
1.	PCB(Main board)	HI3536_10HD D_NVR	N/A	N/A	N/A	N/A	N/A
2.	PCB-1	V06/V04_FRO NT-USB x2	N/A	N/A	N/A	N/A	N/A
3	Switching Power Supply	FSP200-50GSV -5K.	N/A	E190414	FSP GROUP INC.	N/A	N/A
4	FAN	N/A	N/A	N/A	XING XIN	N/A	N/A

Note: All the above equipment /cable were placed in worse case position to maximize emission signals during emission test.

Grounding: Grounding was in accordance with the manufacturer’s requirement and conditions for the intended use.

1.5 FEATURES OF EUT:

Please refer to user manual or product specification.



2. INSTRUMENT AND CALIBRATION

2.1 MEASURING INSTRUMENT CALIBRATION

The measuring equipment utilized to perform the tests documented in the report has been calibrated once a year or in accordance with the manufacturer's recommendations, and is traceable to recognized national standards.

2.2 TEST AND MEASUREMENT EQUIPMENT

The following list contains measurement equipment used for testing. The equipment conforms to the requirement of CISPR 16-1, ANSI C63.2 and. Other required standards.

Calibration of all test and measurement, including any accessories that may effect such calibration, is checked frequently to ensure the accuracy. Adjustments are made and correction factors are applied in accordance with the instructions contained in the respective.

TABLE 1 LIST OF TEST AND MEASUREMENT EQUIPMENT

Conducted Emission Measurement (Test Site ID: GCC_CE-01)					
Instrument	Manufacturer	Model No.	Serial No.	Calibration Due Date	Note
EMC Test Receiver	R&S	ESCI	100438	Dec. 16, 2016	
LISN #1	SCHWARZBECK	NNLK8121	550213	Dec. 15, 2016	For EUT
LISN #2	EMCO	3825/2	9001-1400	N/A	For Support Unit
RF Cable	Huber+Suhner	RG223/U	Cable-001	Dec.17, 2017	
Impedance Stabilization	Teseq GmbH	ISNT800	23334	Sep. 19, 2016	
Absorbing Clamp	COM-POWER	AB-050	421915	Oct. 27,2016	
RF Cable	Huber+Suhner	5D-FB	CABLE-007	Oct. 29,2016	
Test Software	AUDIX	E3	6.2008-10-2C	N/A	
3m/10m Open Area Test Site Radiated Emission Measurement (Test Site ID: GCC_RE-01)					
Instrument	Manufacturer	Model No.	Serial No.	Calibration Due Date	Note
Bilog Antenna	SUNOL	JB1	A052104	Feb. 21, 2017	
EMC Test Receiver	LIG	ISA-80	L0809K001	Feb.22, 2017	
RF Cable	JYE BAO	RG214/U	Cable-002	Nov. 19, 2016	
Pre-Amplifier	WIRELESS	FPA-6592G	60021	Nov. 11, 2016	
Test Software	AUDIX	E3	6.2009-5-7a(n)gcc	N/A	
966_3m EMC Chamber Radiated Emission Measurement (Test Site ID: GCC_RE-02 and GCC_RE-02G)					



Instrument	Manufacturer	Model No.	Serial No.	Calibration Due Date	Note
EMC Test Receiver	LIG	ER-265	L0907B006	Jul. 08, 2016	
Bilog Antenna	SUNOL	JB1	A052204	Nov. 26, 2017	
Pre-Amplifier	WIRELESS	FPA-6592G	60028	Sep. 29, 2016	
RF Cable_NSA_Rx	HUBER + UHNER	RG213/U	Cable-004	Jul. 27, 2016	
Double Ridged Guide Horn Antenna	EST.LINDGREN	3117	00119028	Oct.01, 2016	
Microwave Cable	HUBER SUHNER	SUCOFLEX 104	Cable-003-4M	Jan. 26, 2017	
Microwave Cable	HUBER SUHNER	SUCOFLEX 104	Cable-003-3M	Jan. 26, 2017	
Microwave Preamplifier	EMCINSTRUMENT	EMC051845	980059	Mar. 23, 2017	
Test Software	AUDIX	E3	6.101222	N/A	

✧ Calibration interval of instruments listed above is one year

2.3 TEST PERFORMED

Conducted emissions were investigated over the frequency range from 0.15MHz to 30MHz using a receiver which bandwidth is set at 9 KHz.

Radiated emissions were investigated over the frequency range from 30MHz to 1000MHz using a receiver which bandwidth is set at 120KHz. Radiated measurement was performed at distance that from an antenna to EUT is 10meters.

2.4 APPENDIX

Appendix A: Measurement Procedure for Main Power Port Conducted Emissions

The measurements are performed in a Global lab's room; The EUT was placed on non-conductive 1.0m x 1.5m table, which is 0.8 meters above an earth-grounded.

Power to the EUT was provided through the LISN which has the Impedance (50ohm/50uH) vs. Frequency Characteristic in accordance with the standard. Powers to the LISNs were filtered to eliminate ambient signal interference and these filters were bonded to the ground plane. Peripheral equipment required to provide a functional system (support equipment) for EUT testing was powered from the second LISN through a ganged, metal power outlet box which is bonded to the ground plane at the LISN.

If the EUT is supplied with a flexible power cord, the power cord length in excess of the distance separating the EUT from the LISN shall be folded back and forth at the center of the lead so as to form a bundle not exceeding 40cm in length. If the EUT is provided with a permanently coiled power cord, bundling of the cord is not required. If the EUT is supplied without a power cord, the EUT shall be connected to the LISN by a power cord of the type specified by the manufacturer which shall not be longer than 1 meter. The excess power cord



shall be bundled as described above. If a non-flexible power cord is provided with the EUT, it shall be cut to the length necessary to attach the EUT to the LISN and shall not be bundled.

The interconnecting cables were arranged and moved to get the maximum measurement. Both the line of power cord, hot and neutral, was measured.

The highest emissions were analyzed in details by operating the spectrum analyzer in fixed tuned mode to determine the nature of the emissions and to provide information which could be useful in reducing their amplitude.

Appendix B: Test Procedure for Radiated Emissions

Preliminary Measurements in the Anechoic Chamber

The radiated emissions are initially measured in the anechoic chamber at a measurement distance of 3 meters. Desktop EUT are placed on a wooden stand 0.8 meter in height. The measurement antenna is 3 meters from the EUT. The test setup in anechoic chamber is the same as open site. The turntable rotated 360°. The antenna height is 1m. The primary objective of the radiated measurements in the anechoic chamber is to identify the frequency spectrum in the absence of the electromagnetic environment existing on the open test site. The frequencies can then be pre-selected on the open test site to obtain the corresponding amplitude. The initial scan is made with the spectrum analyzer in automatic sweep mode. The spectrum peaks are then measured manually to determine the exact frequencies.

Measurements on the Open Site or Chamber

The radiated emissions test will then be repeated on the open site or chamber to measure the amplitudes accurately and without the multiple reflections existing in the shielded room. The EUT and support equipments are set up on the turntable. Desktop EUT are set up on a wooden stand 0.8 meter above the ground.

For the initial measurements, the receiving antenna is varied from 1-4 meter height and is changed in the vertical plane from vertical to horizontal polarization at each frequency. Both reading are recorded with the quasi-peak detector with 120KHz bandwidth. For frequency between 30 MHz and 1000MHz, the reading is recorded with peak detector or quasi-peak detector. For the frequency range is above 1 GHz, the EUT was positioned such that distance from antenna to the EUT is 3 meters. The bandwidth set on the field strength is 1 MHz when the frequency range is above 1GHz.

At the highest amplitudes observed, the EUT is rotated in the horizontal plane while changing the antenna polarization in the vertical plane to maximize the reading. The interconnecting cables were arranged and moved to get the maximum measurement. Once the maximum reading is obtained, the antenna elevation and polarization will be varied between specified limits to maximize the readings.



Appendix C: Warning Labels

Label Requirements

A Class A digital device subject to certification by the FCC shall carry a warning label which includes the following statement:

***** WARNING *****

This device complies with Part 15 of the FCC Rules. Operation is subject to the following two conditions: (1) this device may not cause harmful interference, and (2) this device must accept any interference received, including interference that may cause undesired operation.

Appendix D: Warning Statement

Statement Requirements

The operator's manual for a Class A digital device shall contain the following statements or their equivalent:

***** WARNING *****

This equipment has been tested and found to comply with the limits for a Class A digital device, pursuant to part 15 of the FCC Rules. These limits are designed to provide reasonable protection against harmful interference when the equipment is operated in a commercial environment. This equipment generates, uses, and can radiate radio frequency energy and, if not installed and used in accordance with the instruction manual, may cause harmful interference to radio communications. Operation of this equipment in a residential area is likely to cause harmful interference in which case the user will be required to correct the interference at his own expense.

Notice: The changes or modifications not expressly approved by the party responsible for compliance could void the user's authority to operate the equivalent.

* * * * *

If the EUT was tested with special shielded cables the operator's manual for such product shall also contain the following statements or their equivalent:

Shielded interface cables and/or AC power cord, if any, must be used in order to comply with the emission limits.

3. CONDUCTED EMISSION MEASUREMENT

3.1 TEST SET-UP

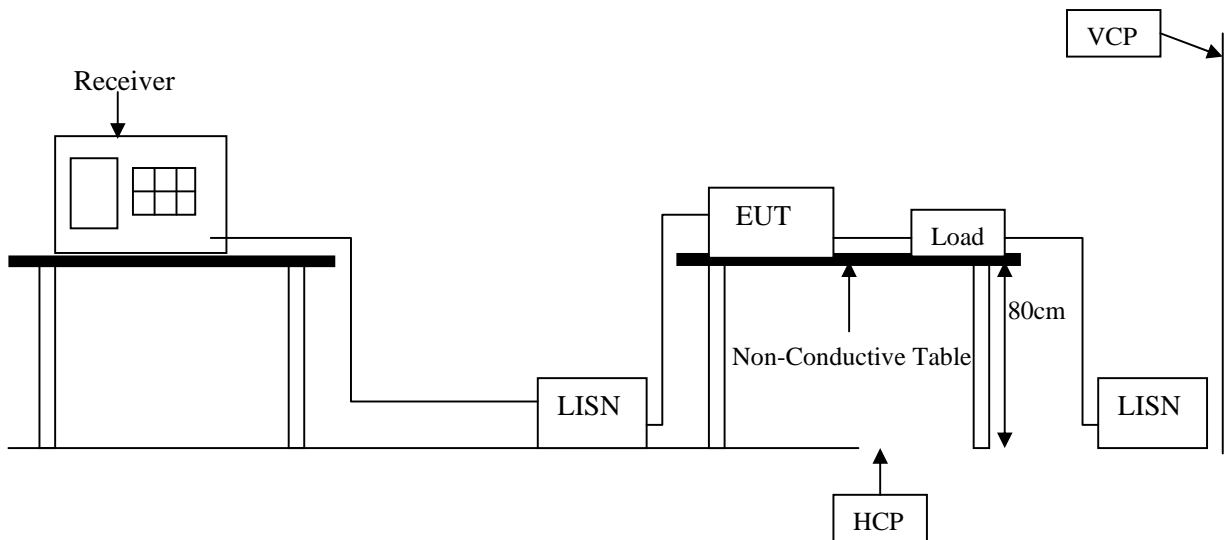

3.2 LIMIT

Frequency range (MHz)	CLASS A		CLASS B		Receiver RBW
	QP dB(uV)	Average dB(uV)	QP dB(uV)	Average dB(uV)	
0.15-0.5	79 dBuV	66 dBuV	66 - 56 dBuV	56 - 46 dBuV	9KHz
0.5-5.0	73 dBuV	60 dBuV	56 dBuV	46 dBuV	9KHz
5.0-30.0	73 dBuV	60 dBuV	60 dBuV	50 dBuV	9KHz

Remark: In the above table, the tighter limit applies at the band edges.

3.3 TEST PROCEDURE

The EUT and simulators are connected to the main power through a line impedance stabilization network (LISN). It provides a 50 ohm / 50 μH coupling impedance for the measuring equipment. The peripheral devices are also connected to the main power through a LISN that provides a 50 ohm / 50 μH coupling impedance with 50 ohm termination. (Please refer to the block diagram of the test setup and photograph.)

Both sides of AC line are checked for the maximum conducted emission interference. In order to find the maximum emissions, the relating positions of equipment and all of the interference cables must be changed according to CISPR22 regulation: The measurement procedure on conducted emission interference.

The resolution bandwidth of the field strength meter is set at 9 KHz.



3.4 TEST SPECIFICATION

ANSI C63.4:2014 & CISPR 22 Class A

3.5 TEST DATA:

Please refer to appendix 2.

3.6 RESULT:
PASS

4. RADIATED EMISSION MEASUREMENT

4.1 TEST SETUP

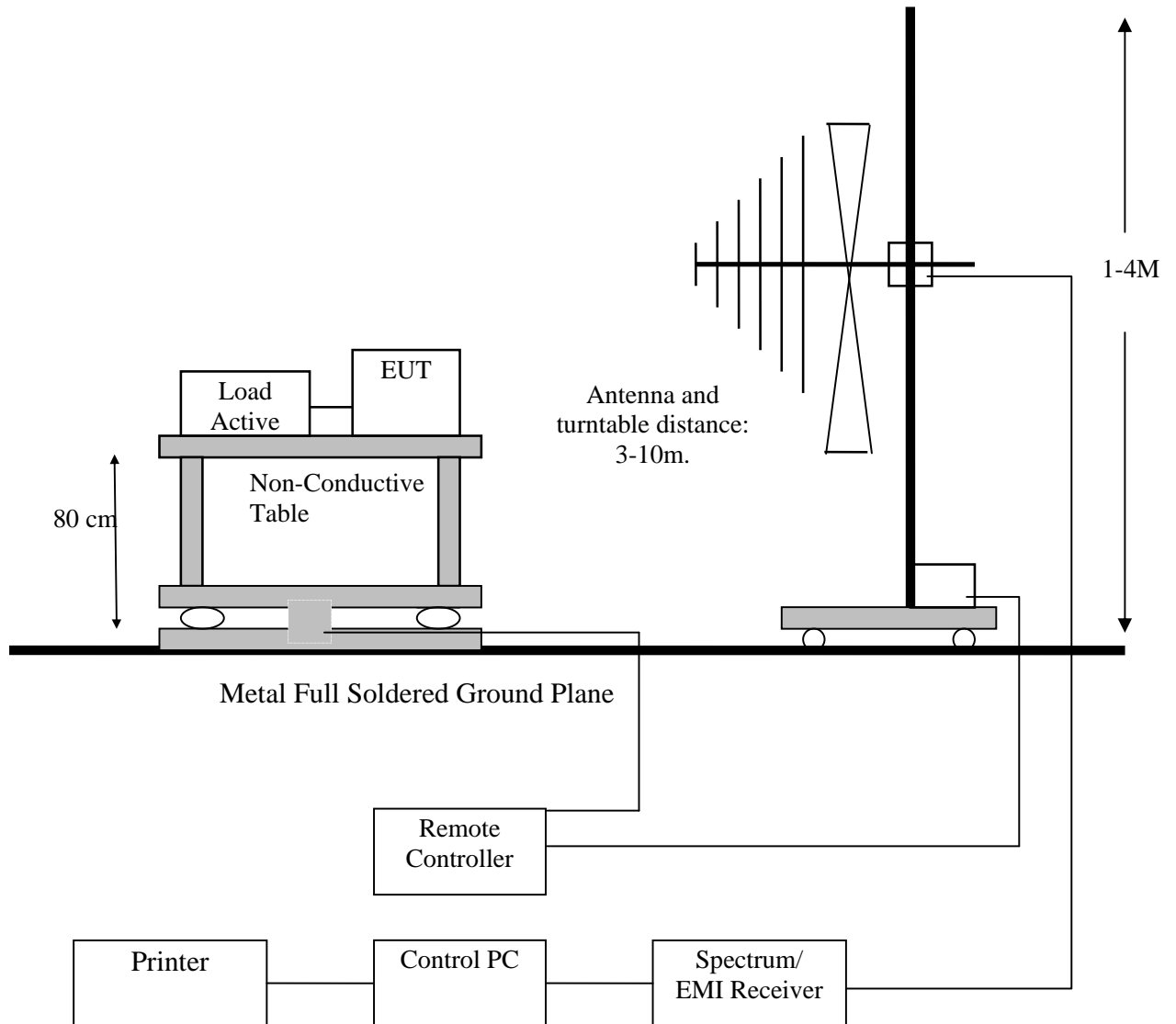



4.2 LIMIT

Frequency	Class A		Class B		Receiver RBW
MHz	Distance (Meter)	Limit dB μ V/m	Distance (Meter)	Limit dB μ V/m	
30 ~ 230	10	40	10	30	120KHz
	3	50	3	40	
230 ~ 1000	10	47	10	37	120KHz
	3	57	3	47	

Class A

Frequency range MHz	Average limit dB(μ V/m)	Peak limit dB(μ V/m)	Receiver RBW
Above 1000	60	80	1MHz

Class B

Frequency range MHz	Average limit dB(μ V/m)	Peak limit dB(μ V/m)	Receiver RBW
Above 1000	54	74	1MHz

Remark: In the above table, the tighter limit applies at the band edges

4.3 TEST PROCEDURE

The EUT and its simulators are placed on turn table, non-conductive and wooden table, which is 0.8 meter above ground. The turn table rotates 360 degree to determine the position of the maximum emission level. The EUT was positioned such that distance from antenna to the EUT is 10 meters(OATS) or 3 meters(SAC). For the frequency range is above 1 GHz, the EUT was positioned such that distance from antenna to the EUT is 3 meters.

The antenna is moved up and down between 1 meter to 4 meter to receive the maximum emission level.

Both horizontal and vertical polarizations of the antenna are set on measurement. In order to find the maximum emission, all of the interference cables must be manipulated according to CISPR 22 regulation: the test procedure of the radiated emission measurement.

The bandwidth set on the field strength is 120 KHz when the frequency range is below 1GHz. The bandwidth set on the field strength is 1 MHz when the frequency range is above 1GHz.



4.4 TEST SPECIFICATION

ANSI C63.4:2014 & CISPR 22 Class A

4.5 TEST DATA:

Please refer to appendix 2.

4.6 RESULT:

PASS

The radiated mission test was PASS at minimum margin :

(30MHz~1GHz)

Horizontal/Vertical 250.02 MHz/ Level 44.97 dBuV/m/ Over limit -2.03 dB,
Antenna Height 1.6 Meter, Turn Table 125 degree.

(1GHz~6GHz)

Horizontal/Vertical 1125 MHz/ Level 52.93 dBuV/m/ Over limit -23.07 dB,
Antenna Height 3 Meter, Turn Table 120 degree..



5. EMC MODIFICATION & ESTIMATED MEASUREMENT UNCERTAINTY

5.1 EMC MODIFICATION

No additional EMC solution was made during the Compliance testing.

5.2 ESTIMATED MEASUREMENT UNCERTAINTY

The estimated measurement uncertainty is calculated in accordance with CISPR16-4-2, the total uncertainty for this test is listed as below:

Uncertainty of Conducted Emission Measurement (150KHz~30MHz)

Contribution	Probability Distribution	150KHz – 30MHz
Measuring uncertainty for a level of confidence of 95% $U=2Ue(y)$	Normal (k=2)	± 3.2 dB

Uncertainty of Radiated Emission Measurement (30MHz~1GHz)

Contribution	Probability Distribution	30MHz~1GHz
Measuring uncertainty for a level of confidence of 95% $U=2Ue(y)$	Normal (k=2)	± 2.7 dB

Uncertainty of Radiated Emission Measurement (1GHz~18GHz)

Contribution	Probability Distribution	1GHz~18GHz
Measuring uncertainty for a level of confidence of 95% $U=2Ue(y)$	Normal (k=2)	± 4.2 dB



SAMPLE OF FCC VERIFICATION LABEL 1

This device complies with part 15 of the FCC Rules.
Operation is subject to the following two conditions: (1)
This device may not cause harmful interference. And (2)
this device must accept any interference received, including
interference that may cause undesired operation.

SAMPLE OF FCC DOC LABEL 2

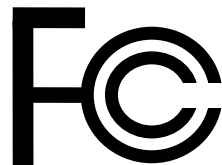

Trade Name
Model Number



Global Certification Corp.

Appendix 1

PHOTOS OF TEST CONFIGURATION

01 CE Front View



02 CE Rear View



03 RE Front View



04 RE Rear View



05 RE 1-6G Front View (966)

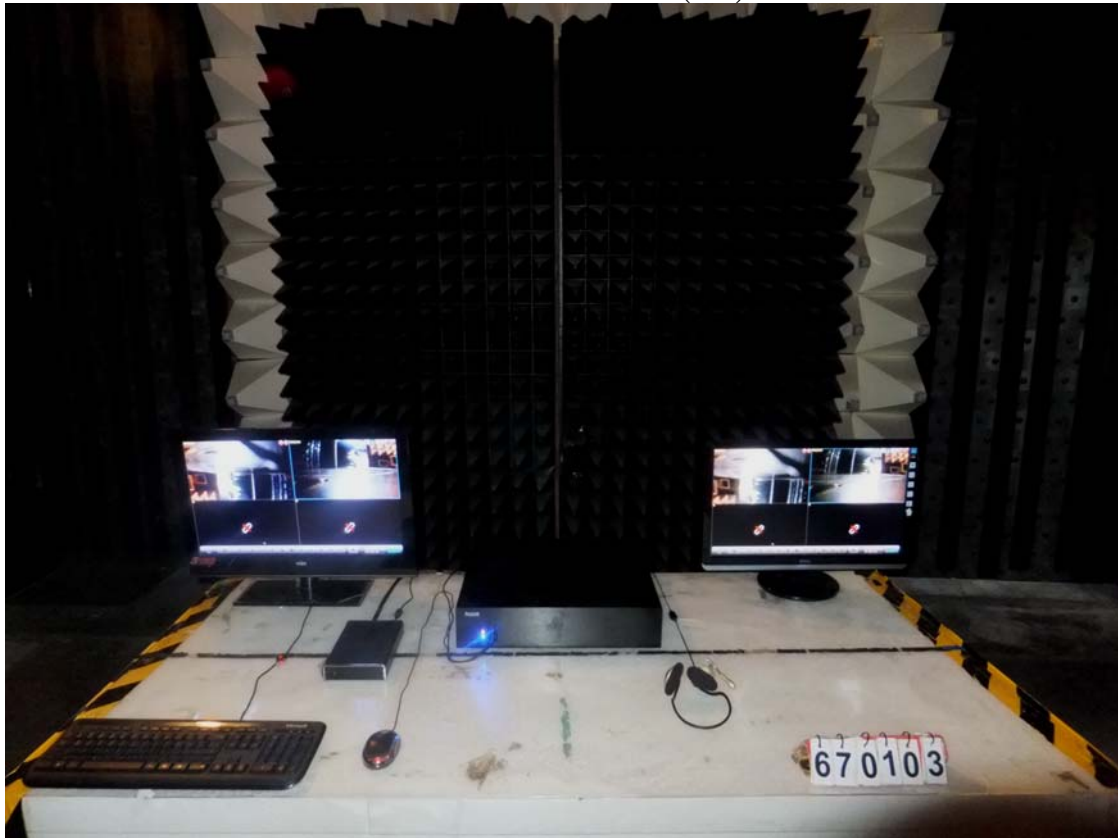

06 RE 1-6G Rear View (966)

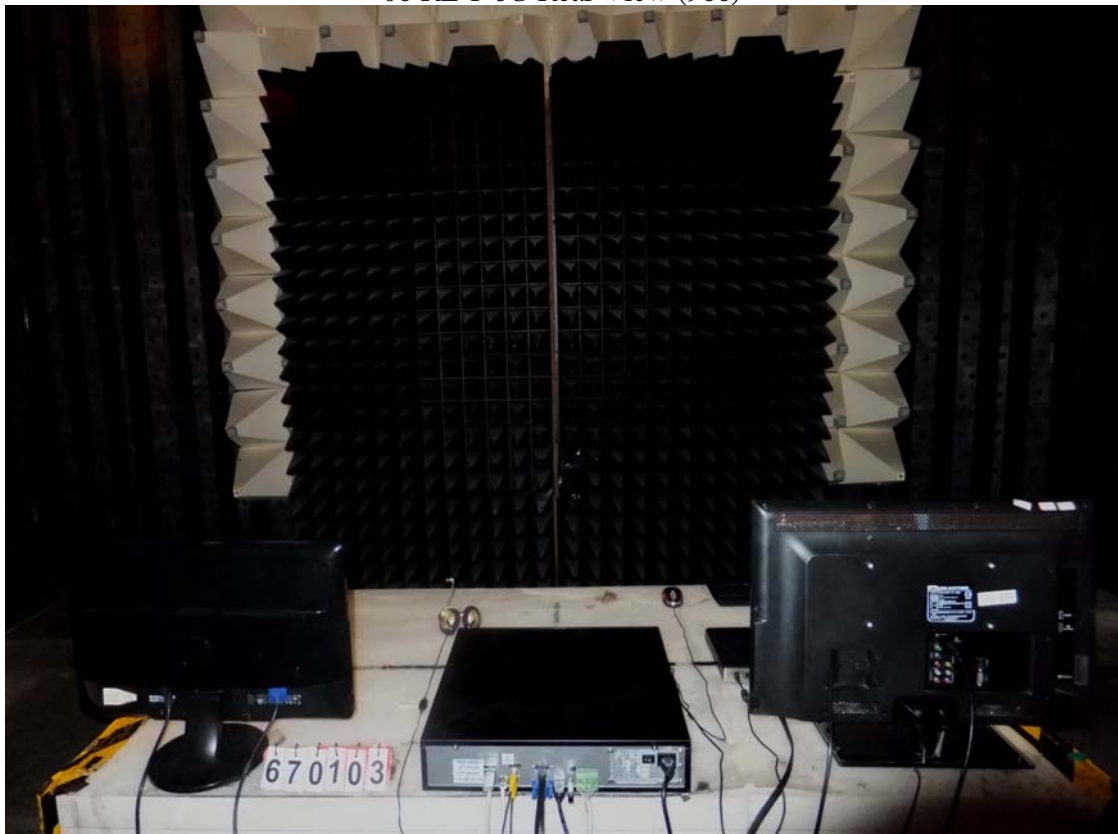



Global Certification Corp.

Appendix 2

TEST DATA

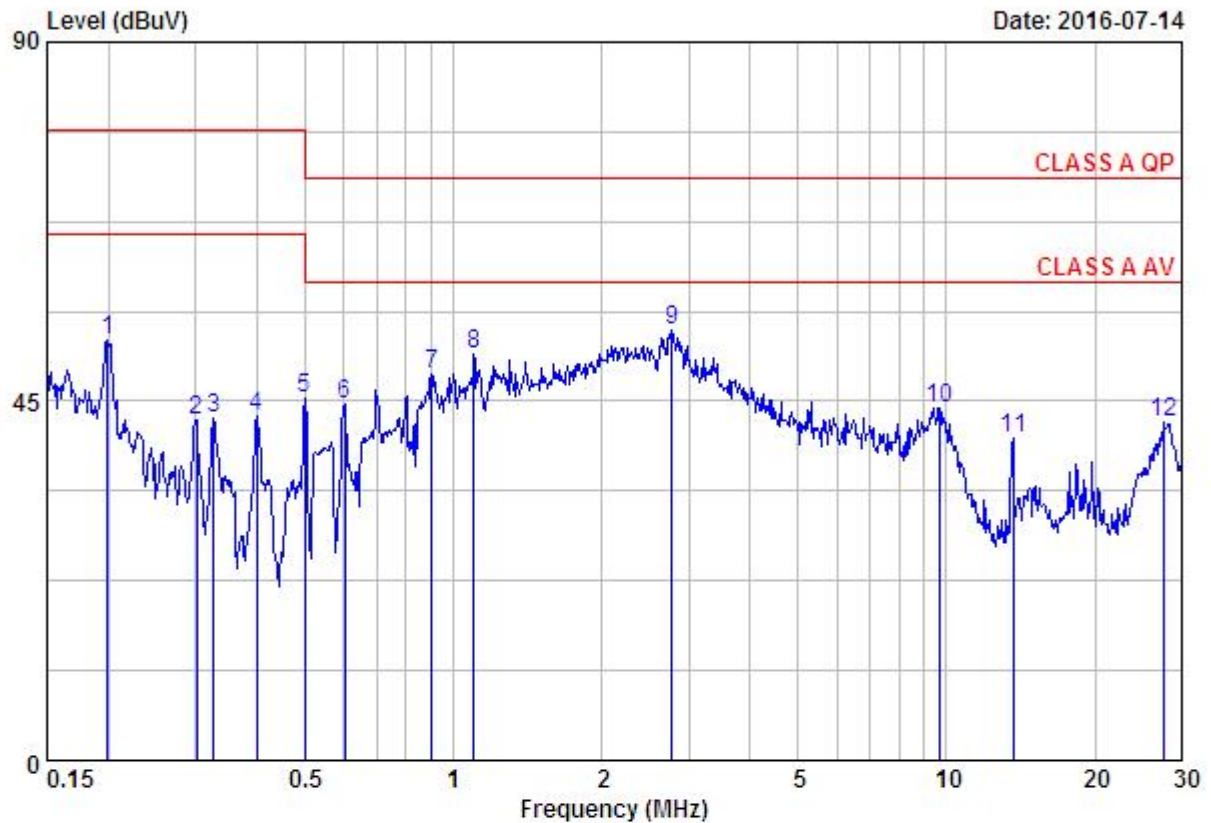

Site : Conduction Test Site 1
 Condition : CLASS A QP LINE
 : RBW:9 KHz VBW:300 KHz
 EUT : See Page 1 of EMC Report
 MODEL : See Page 1 for Details
 Test Mode : Recorder ; LAN 100M
 120Vac 60Hz 27.5°C 56%

Peak	Freq	Meter Level	System Factor	Cable Loss	LISN Factor	Real Level	Limit Line	Over Limit	Remark
	MHz	dBuV	dB	dB	dB	dBuV	dBuV	dBuV	dB
1	0.20	52.54	0.00	0.02	-0.02	52.54	79.00	-26.46	Peak
2	0.30	42.72	-0.01	0.02	-0.03	42.71	79.00	-36.29	Peak
3	0.33	42.86	0.00	0.03	-0.03	42.86	79.00	-36.14	Peak
4	0.40	43.13	0.00	0.03	-0.03	43.13	79.00	-35.87	Peak
5	0.50	45.32	0.00	0.03	-0.03	45.32	79.00	-33.68	Peak
6	0.60	44.69	0.00	0.03	-0.03	44.69	73.00	-28.31	Peak
7	0.90	48.36	0.01	0.04	-0.03	48.37	73.00	-24.63	Peak
8	1.10	50.90	0.00	0.04	-0.04	50.90	73.00	-22.10	Peak
9	2.78	53.83	0.02	0.07	-0.05	53.85	73.00	-19.15	Peak
10	9.71	44.21	0.02	0.13	-0.11	44.23	73.00	-28.77	Peak
11	13.62	40.47	0.02	0.15	-0.13	40.49	73.00	-32.51	Peak
12	27.56	42.32	-0.01	0.21	-0.22	42.31	73.00	-30.69	Peak

System Factor = Cable Loss + LISN Factor
 Real Level = Meter Level + System Factor
 Over Limit = Real Level - Limit Line

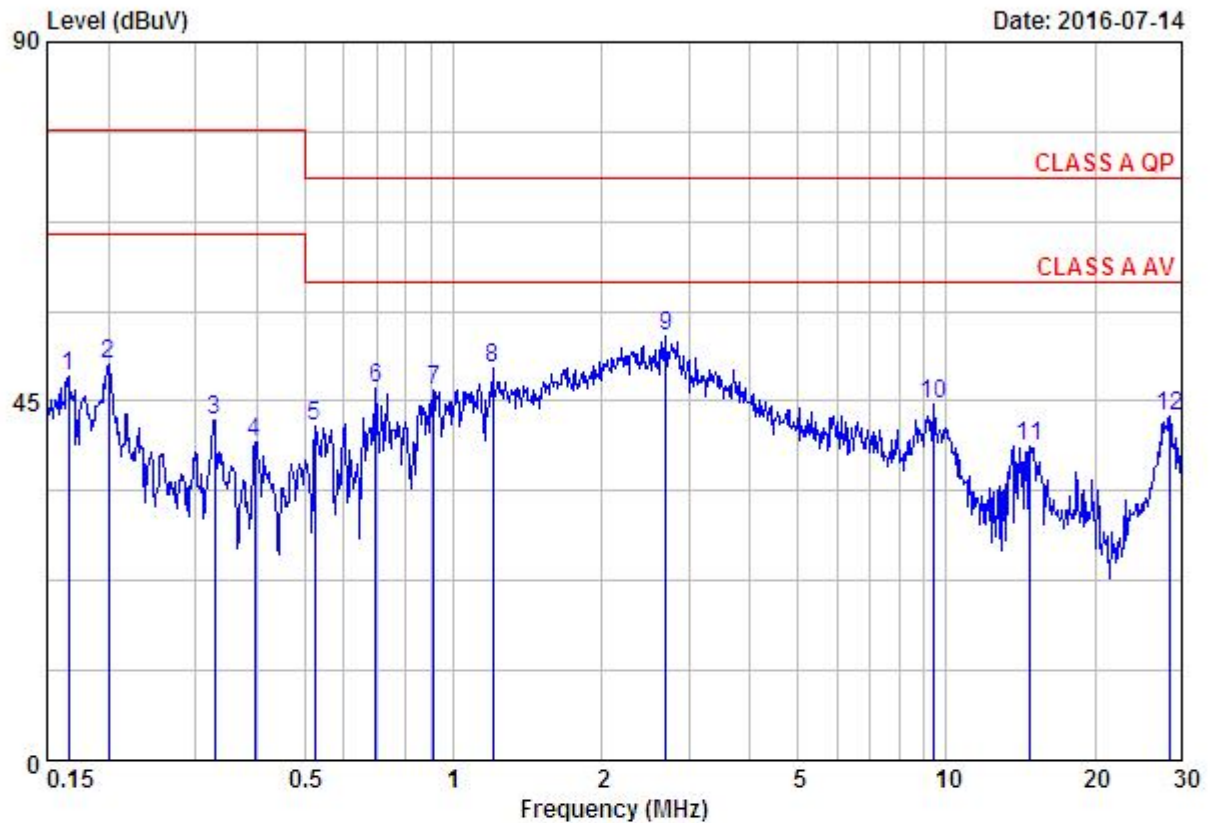

Site : Conduction Test Site 1
 Condition : CLASS A QP NEUTRAL
 : RBW:9 KHz VBW:300 KHz
 EUT : See Page 1 of EMC Report
 MODEL : See Page 1 for Details
 Test Mode : Recorder ; LAN 100M
 120Vac 60Hz 27.5°C 56%

Freq	Meter Level	System Factor	Cable Loss	LISN Factor	Real Level	Limit Line	Over Limit	Remark	
MHz	dBuV	dB	dB	dB	dBuV	dBuV	dBuV	dB	
1	0.17	48.01	0.01	0.02	-0.01	48.02	79.00	-30.98	Peak
2	0.20	49.59	0.01	0.02	-0.01	49.60	79.00	-29.40	Peak
3	0.33	42.56	0.02	0.03	-0.01	42.58	79.00	-36.42	Peak
4	0.40	39.94	0.01	0.03	-0.02	39.95	79.00	-39.05	Peak
5	0.52	41.81	0.01	0.03	-0.02	41.82	73.00	-31.18	Peak
6	0.70	46.55	0.01	0.03	-0.02	46.56	73.00	-26.44	Peak
7	0.91	46.38	0.02	0.04	-0.02	46.40	73.00	-26.60	Peak
8	1.20	49.15	0.02	0.05	-0.03	49.17	73.00	-23.83	Peak
9	2.69	53.09	0.03	0.07	-0.04	53.12	73.00	-19.88	Peak
10	9.45	44.60	0.03	0.13	-0.10	44.63	73.00	-28.37	Peak
11	14.75	39.39	0.02	0.16	-0.14	39.41	73.00	-33.59	Peak
12	28.30	43.12	0.00	0.21	-0.21	43.12	73.00	-29.88	Peak

System Factor = Cable Loss + LISN Factor
 Real Level = Meter Level + System Factor
 Over Limit = Real Level - Limit Line

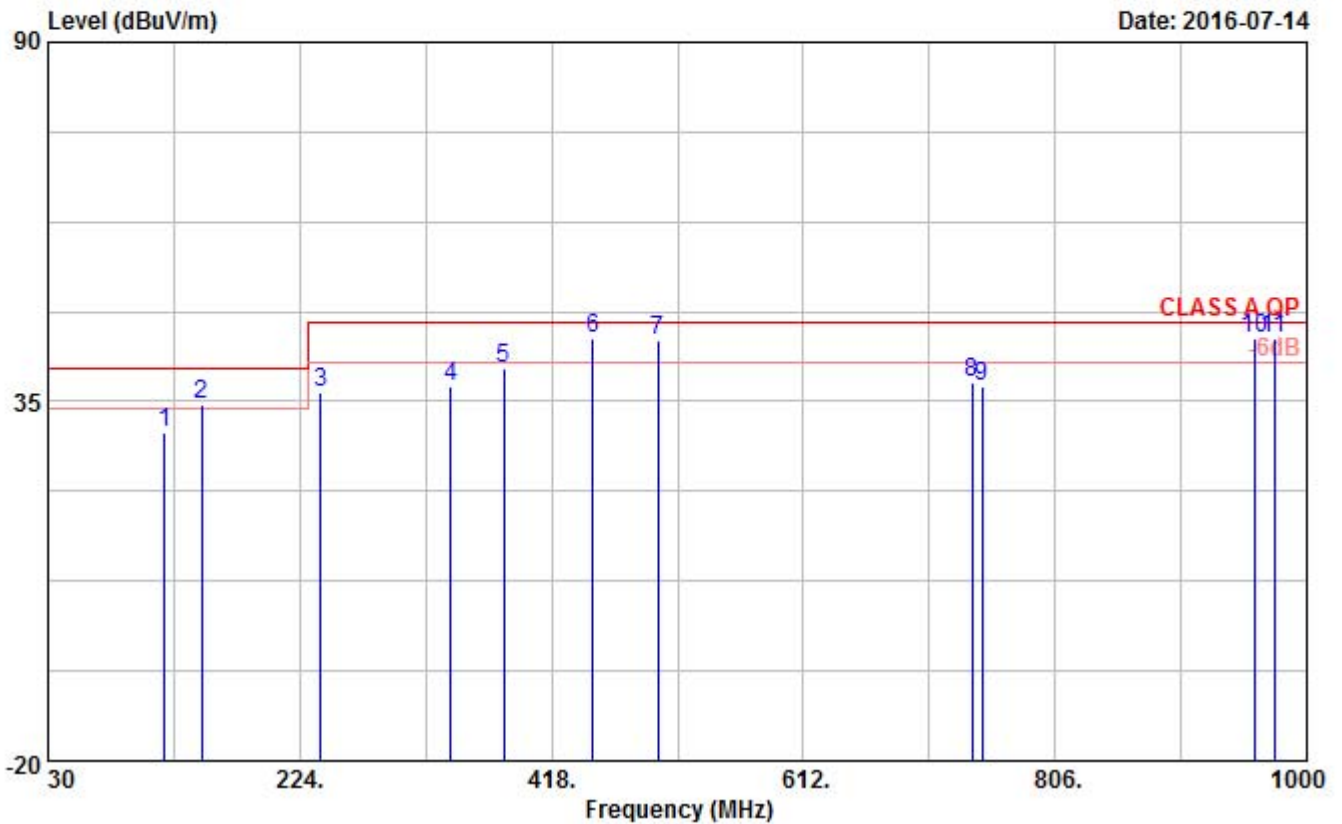

Site : GCC_RE-01
Condition : CLASS A QP VERTICAL
: RBW:120 KHz VBW:300 KHz
EUT : See Page 1 of EMC Report
MODEL : See Page 1 for Details
Test mode : Recorder ; LAN 100M
120Vac 60Hz 28.5°C 59%

	Meter Freq	Meter Level	System Factor	Cable Loss	Antenna Factor	Preamp Gain	Real Level	Limit Line	Over Limit	Remark
	MHz	dBuV	dB/m	dB	dB/m	dB	dBuV/m	dBuV/m	dB	
1	120.00	44.38	-14.24	2.25	14.30	30.79	30.14	40.00	-9.86	QP
2	148.34	49.98	-15.47	2.50	12.83	30.80	34.51	40.00	-5.49	QP
3	240.00	52.29	-15.96	3.28	11.60	30.84	36.33	47.00	-10.67	QP
4	340.40	49.96	-12.59	4.07	14.21	30.87	37.37	47.00	-9.63	QP
5	381.14	51.31	-11.40	4.33	15.15	30.88	39.91	47.00	-7.09	QP
6	450.00	53.67	-9.11	4.74	17.00	30.85	44.56	47.00	-2.44	QP
7	500.01	52.09	-7.88	5.03	17.90	30.81	44.21	47.00	-2.79	QP
8	741.98	40.87	-2.84	6.29	21.00	30.13	38.03	47.00	-8.97	QP
9	750.01	39.93	-2.67	6.33	21.10	30.10	37.26	47.00	-9.74	QP
10	960.00	43.49	1.26	7.37	23.26	29.37	44.75	47.00	-2.25	QP
11	975.00	42.90	1.62	7.44	23.50	29.32	44.52	47.00	-2.48	QP

System Factor = Cable Loss + Antenna Factor - Preamp Gain
Real Level = Meter Level + System Factor
Over Limit = Real Level - Limit Line

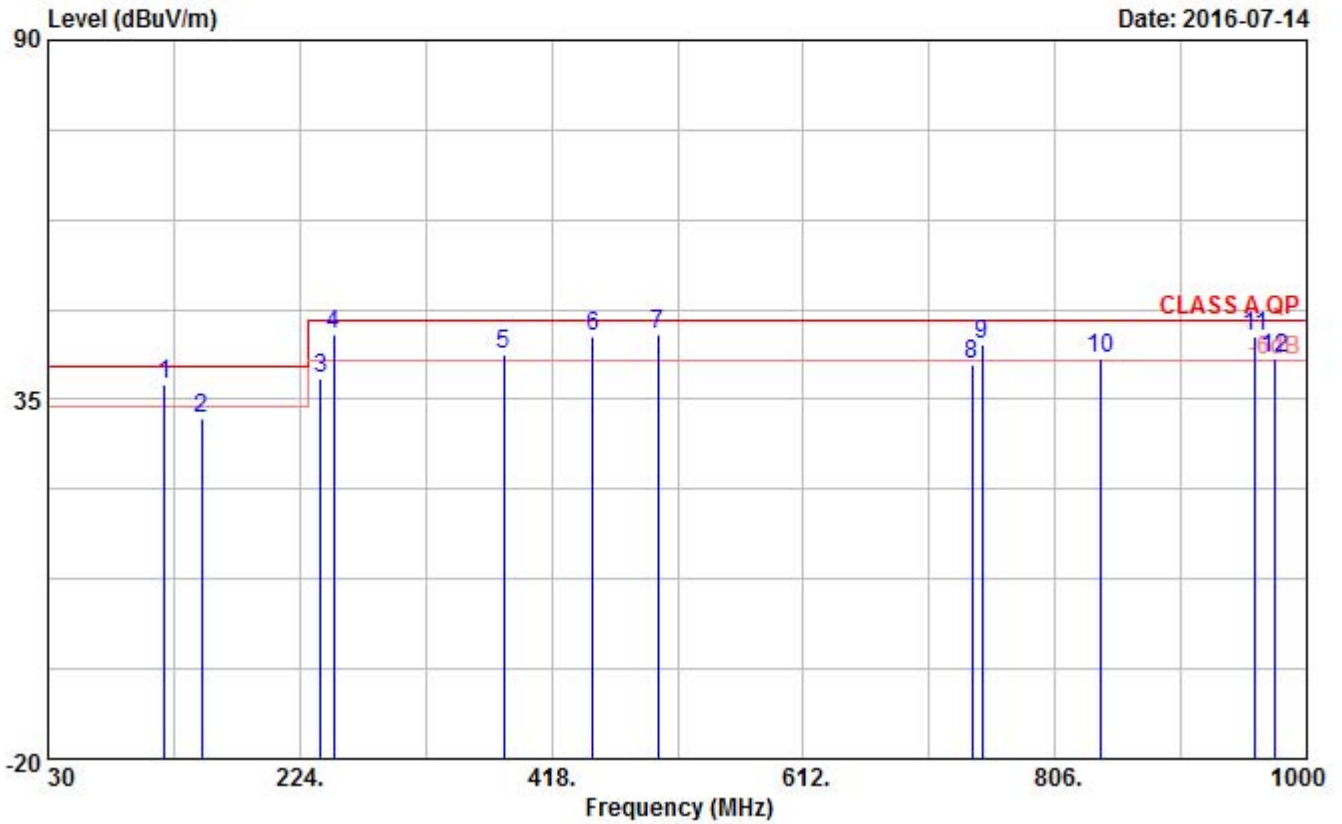

Site : GCC_RE-01
Condition : CLASS A QP HORIZONTAL
: RBW:120 KHz VBW:300 KHz
EUT : See Page 1 of EMC Report
MODEL : See Page 1 for Details
Test mode : Recorder ; LAN 100M
120Vac 60Hz 28.5°C 59%

	Meter	System	Cable	Antenna	Preamp	Real	Limit	Over	
	Freq	Level	Factor	Loss	Factor	Gain	Level	Line	Limit Remark
	MHz	dBuV	dB/m	dB	dB/m	dB	dBuV/m	dBuV/m	dB
1	120.00	51.40	-14.24	2.25	14.30	30.79	37.16	40.00	-2.84 QP
2	148.34	47.69	-15.47	2.50	12.83	30.80	32.22	40.00	-7.78 QP
3	240.01	54.05	-15.96	3.28	11.60	30.84	38.09	47.00	-8.91 QP
4	250.02	60.86	-15.89	3.36	11.60	30.85	44.97	47.00	-2.03 QP
5	381.14	53.21	-11.40	4.33	15.15	30.88	41.81	47.00	-5.19 QP
6	450.02	53.82	-9.11	4.74	17.00	30.85	44.71	47.00	-2.29 QP
7	500.01	52.71	-7.88	5.03	17.90	30.81	44.83	47.00	-2.17 QP
8	741.98	43.27	-2.84	6.29	21.00	30.13	40.43	47.00	-6.57 QP
9	750.01	46.20	-2.67	6.33	21.10	30.10	43.53	47.00	-3.47 QP
10	840.92	42.35	-0.92	6.79	22.05	29.76	41.43	47.00	-5.57 QP
11	960.02	43.27	1.26	7.37	23.26	29.37	44.53	47.00	-2.47 QP
12	974.78	39.65	1.60	7.43	23.50	29.33	41.25	47.00	-5.75 QP

System Factor = Cable Loss + Antenna Factor - Preamp Gain
Real Level = Meter Level + System Factor
Over Limit = Real Level - Limit Line



Data: 1

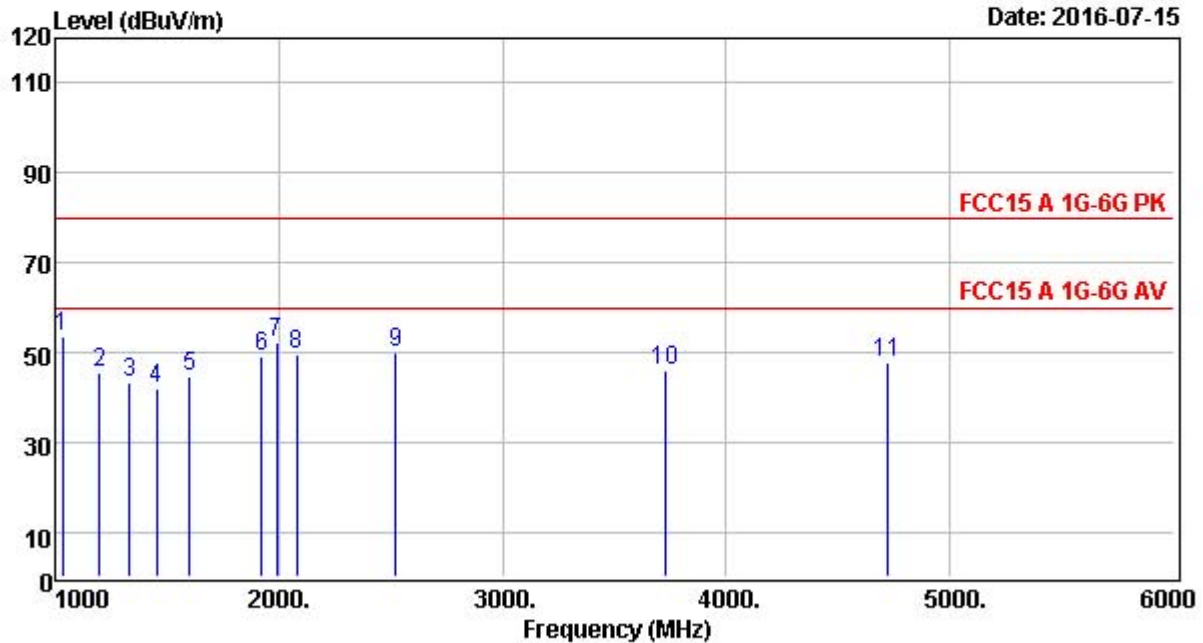

Site : GCC_RE-02
 Condition : FCC15 A 1G-6G PK VERTICAL
 : RBW:1000 VBW:1000
 EUT : See Page 1 of EMC Report
 MODEL : See Page 1 for Details
 MEMO : Recorder ; LAN 100M
 T/H : 120Vac 60Hz 27.8°C 59%
 :
 :

	Meter	System	Cable	Antenna	Preamp	Real	Limit	Over	
Freq	Level	Factor	Loss	Factor	Gain	Level	Line	Limit	Remark
	MHz	dBuV	dB/m	dB	dB/m	dB	dBuV/m	dBuV/m	dB
1	1035.00	77.62	-24.31	2.81	28.07	55.19	53.31	80.00	-26.69 Peak
2	1200.00	69.97	-24.28	3.04	27.94	55.26	45.69	80.00	-34.31 Peak
3	1335.00	67.57	-24.25	3.24	27.83	55.32	43.32	80.00	-36.68 Peak
4	1455.00	66.33	-24.22	3.41	27.74	55.37	42.11	80.00	-37.89 Peak
5	1600.00	68.02	-23.27	3.63	28.46	55.36	44.75	80.00	-35.25 Peak
6	1925.00	69.08	-20.17	4.15	30.93	55.25	48.91	80.00	-31.09 Peak
7	1990.00	71.67	-19.55	4.25	31.42	55.22	52.12	80.00	-27.88 Peak
8	2080.00	68.77	-19.24	4.34	31.60	55.18	49.53	80.00	-30.47 Peak
9	2525.00	67.97	-18.13	4.71	32.13	54.97	49.84	80.00	-30.16 Peak
10	3725.00	62.19	-16.34	5.79	33.00	55.13	45.85	80.00	-34.15 Peak
11	4725.00	62.18	-14.44	6.53	34.00	54.97	47.74	80.00	-32.26 Peak

System Factor = Cable Loss + Antenna Factor - Preamp Gain
 Real Level = Meter Level + System Factor
 Over Limit = Real Level - Limit Line



Data: 2

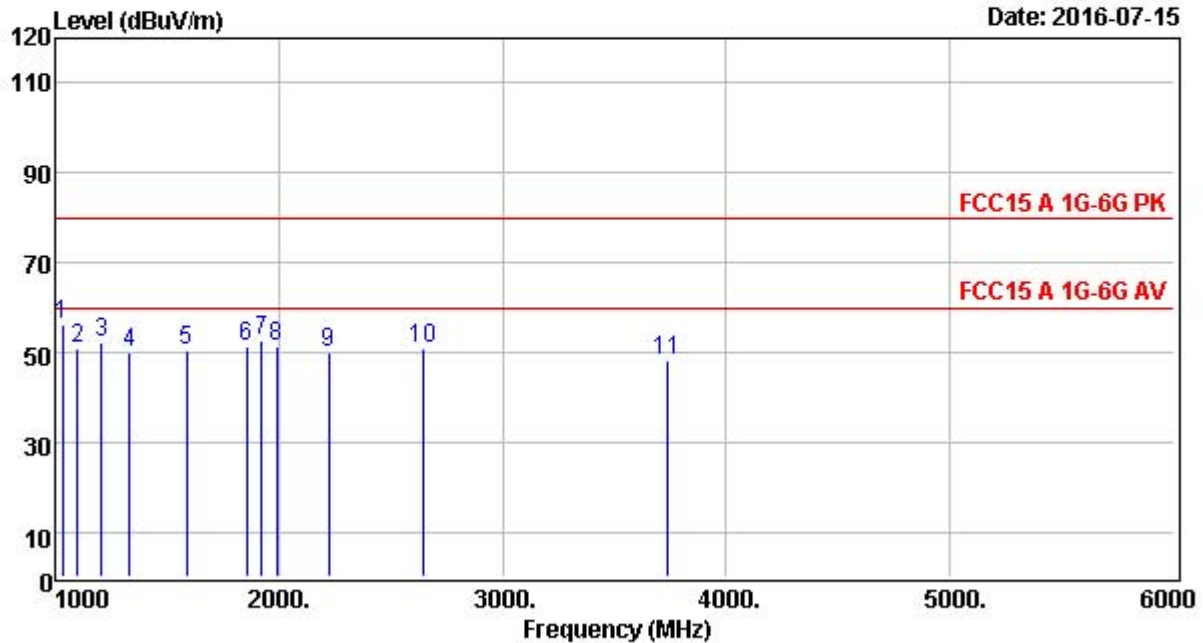

Site : GCC_RE-02
 Condition : FCC15 A 1G-6G PK HORIZONTAL
 : RBW:1000 VBW:1000
 EUT : See Page 1 of EMC Report
 MODEL : See Page 1 for Details
 MEMO : Recorder ; LAN 100M
 T/H : 120Vac 60Hz 27.8°C 59%
 :
 :

	Meter	System	Cable	Antenna	Preamp	Real	Limit	Over	
Freq	Level	Factor	Loss	Factor	Gain	Level	Line	Limit	Remark
MHz	dBuV	dB/m	dB	dB/m	dB	dBuV/m	dBuV/m	dB	
1	1035.00	80.43	-24.31	2.81	28.07	55.19	56.12	80.00	-23.88 Peak
2	1100.00	75.29	-24.29	2.90	28.02	55.21	51.00	80.00	-29.00 Peak
3	1210.00	76.67	-24.27	3.06	27.93	55.26	52.40	80.00	-27.60 Peak
4	1335.00	74.37	-24.25	3.24	27.83	55.32	50.12	80.00	-29.88 Peak
5	1590.00	74.00	-23.37	3.61	28.38	55.36	50.63	80.00	-29.37 Peak
6	1855.00	72.08	-20.83	4.04	30.40	55.27	51.25	80.00	-28.75 Peak
7	1925.00	72.67	-20.17	4.15	30.93	55.25	52.50	80.00	-27.50 Peak
8	1990.00	70.69	-19.55	4.25	31.42	55.22	51.14	80.00	-28.86 Peak
9	2225.00	68.91	-18.87	4.46	31.77	55.10	50.04	80.00	-29.96 Peak
10	2645.00	68.72	-17.94	4.83	32.27	55.04	50.78	80.00	-29.22 Peak
11	3735.00	64.29	-16.31	5.80	33.02	55.13	47.98	80.00	-32.02 Peak

System Factor = Cable Loss + Antenna Factor - Preamp Gain
 Real Level = Meter Level + System Factor
 Over Limit = Real Level - Limit Line